

TEM

On | Off and everything in between



2025

MODUL

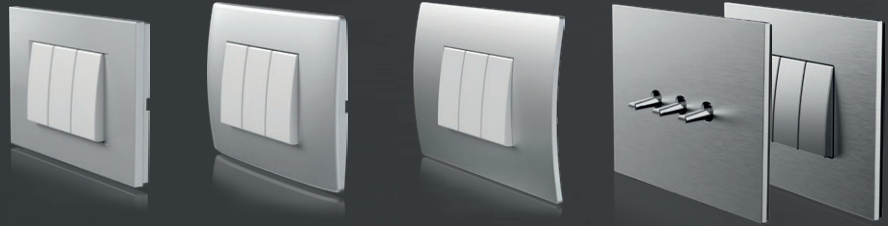

MODUL
LINE

MODUL
SOFT

MODUL
PURE

MODUL
EDGE

44

LOGIQ



LOGIQ
FLAT

LOGIQ
BOLD

LOGIQ
PRIME

172

ekonomik



222

fontana



260



TEM

On | Off and everything in between



Sme výrobcom vypínačov a zásuviek, ktoré používateľom poskytujú pozitívny a ľahký zážitok a zároveň jednoduchou montážou a používaním produktov, širokým výberom farieb a materiálov uspokojia náročné prania každého používateľa a priestoru.

We are a manufacturer of switches and sockets offering a positive and easy user experience while satisfying the most demanding needs of every user and space with products that are easy to install and use, as well as a wide range of colours and materials.

TEM

Vitajte v rodine MODUL

Welcome to the MODUL family

Dodajte miestnosti osobný nádych a zdôraznite svoj štýl pomocou spínačov a zásuviek z rodiny MODUL.

Give your ambience a personal touch and show off your style with switches and sockets from MODUL family.

objavujeme nové perspektívy

discovering new insights



MODUL
LINE



MODUL
SOFT



MODUL
PURE



MODUL
EDGE

1

2

MODUL
LINE



MODUL
SOFT



MODUL
PURE

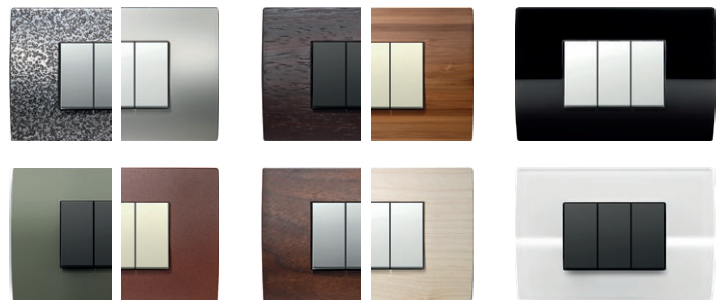

Kov

Drevo

Sklo

MODUL
EDGE

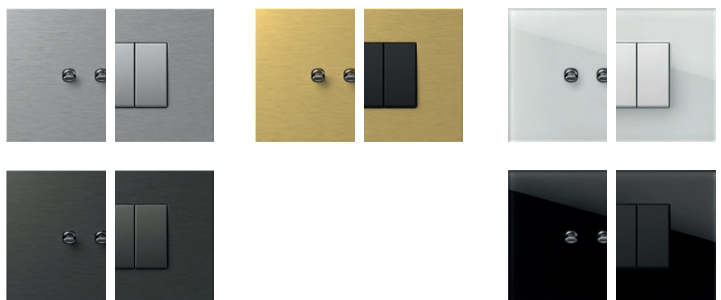

Kov

Kov

Sklo

3

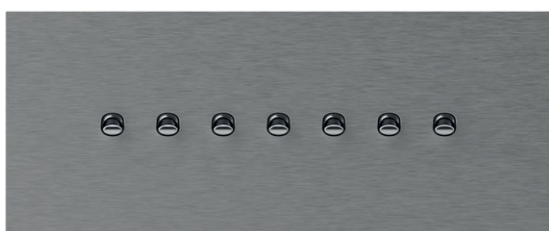

4



MODUL

LINE

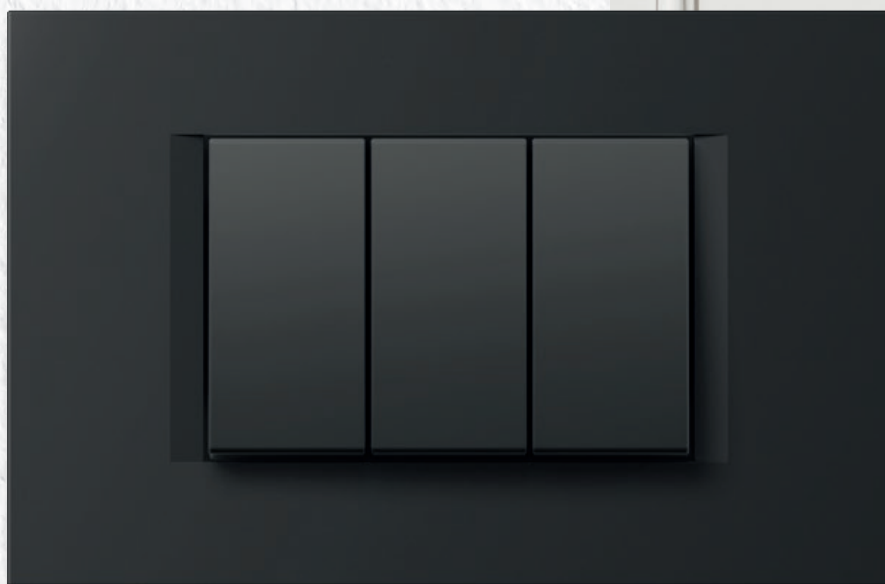

Čisté, rovné linie vytvárajú nadčasový dizajn.

Straight, smooth lines create a timeless design.







MODUL

LINE

PW



biela lesklá

polar white

MW



biela matná

matte white

IW



béžová lesklá

ivory white

ES



strieborná
matná

elox silver

AT



antracitová

anthracite

SB



čierna matná

*soft touch
black*

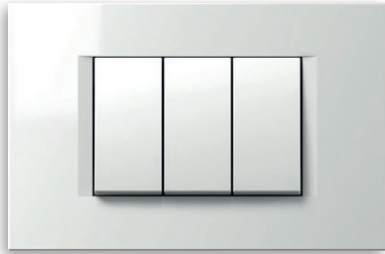

PW biela lesklá
polar white

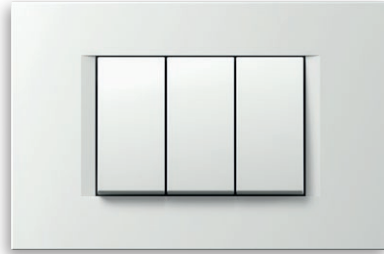

MW biela matná
matte white

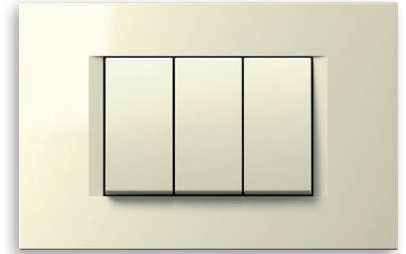

IW béžová lesklá
ivory white



SW mramor biela
stone white



ES strieborná matná
elox silver

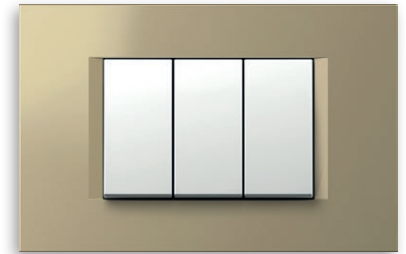

SG zlatá matná
sand gold



TI titánová
titanium

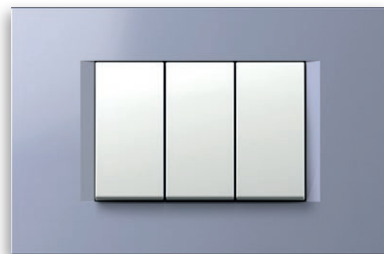

IB modrá matná
impulse blue



AT antracitová
anthracite

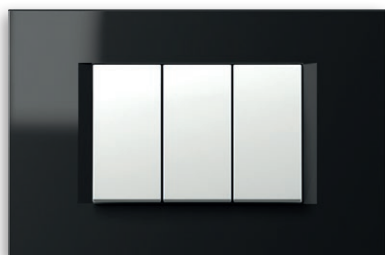

NB čierna lesklá
night black

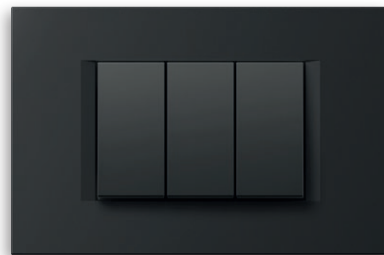

SB čierna matná
soft touch black

MODUL

SOFT



Oblé tvary a mäkké prechody vnesú do vášho domova jemnosť.

Rounded shapes and soft transitions bring softness into your home.





MODUL

SOFT

PW

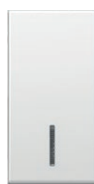

biela lesklá

polar white

MW



biela matná

matte white

IW



béžová lesklá

ivory white

ES



strieborná
matná

elox silver

AT



antracitová

anthracite

SB

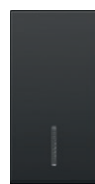

čierna matná

*soft touch
black*

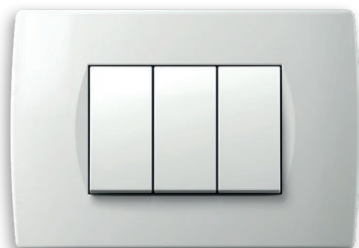

PW biela lesklá
polar white

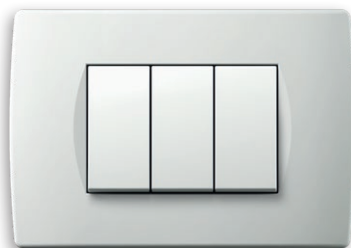

MW biela matná
matte white

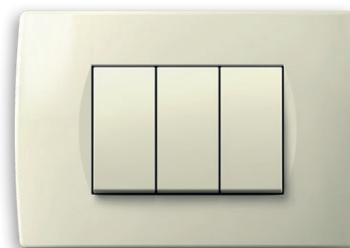

IW béžová lesklá
ivory white



ES strieborná matná
elox silver

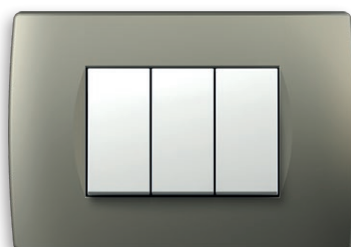

TI titánová
titanium

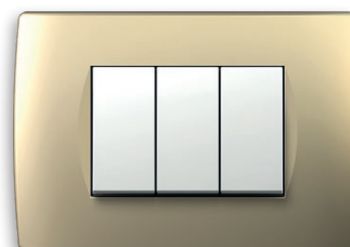

SG zlatá matná
sand gold

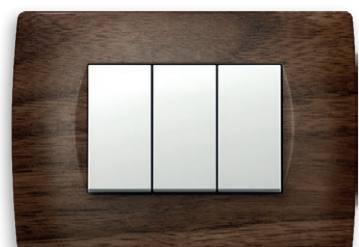

WW orech
walnut



WE wenge
wenge



AT antracitová
anthracite



NB čierna lesklá
night black



SB čierna matná
soft touch black

MODUL

PURE



Dokonalosť atmosféry miestnosti spočíva v detailoch. Dovoľte prírode, aby obohatila váš priestor dekoratívnymi rámkami z dreva, skla a kovu.

The details represent the completeness of the entire ambience. Let the nature enrich your space with decorative cover plates made of wood, glass and metal.





MODUL

PURE

PW



biela lesklá

polar white

MW



biela matná

matte white

IW



béžová lesklá

ivory white

ES



strieborná
matná

elox silver

AT



antracitová

anthracite

SB

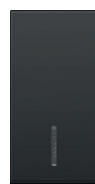

čierna matná

*soft touch
black*

sklo
glass



GL biela
glass light

kov
metal



MH kovaná oceľ
hammered steel

drevo
wood



WM javor
maple

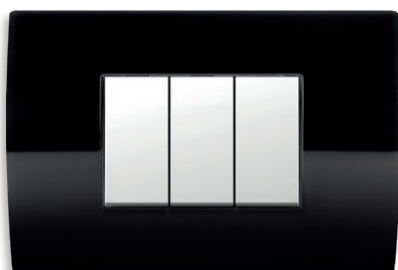

GD čierna
glass dark

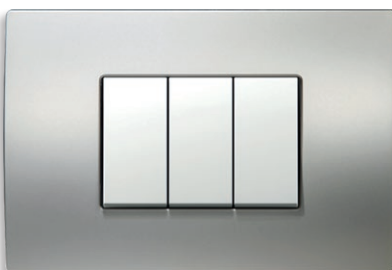

MS satinované striebro
satín silver



WB bambus
bamboo



MN satinovaný nikel
satín nickel



WW orech
walnut

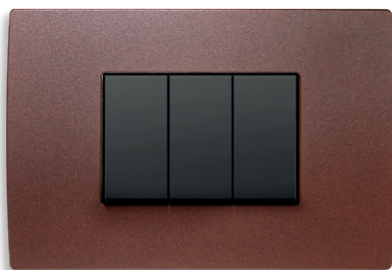

ME zoxidované železo
etched iron

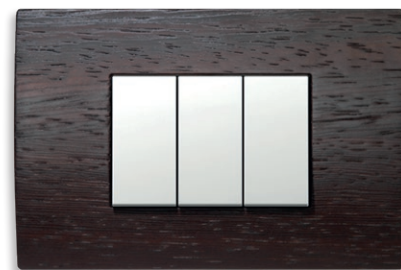

WE wenge
wenge

MODUL

EDGE

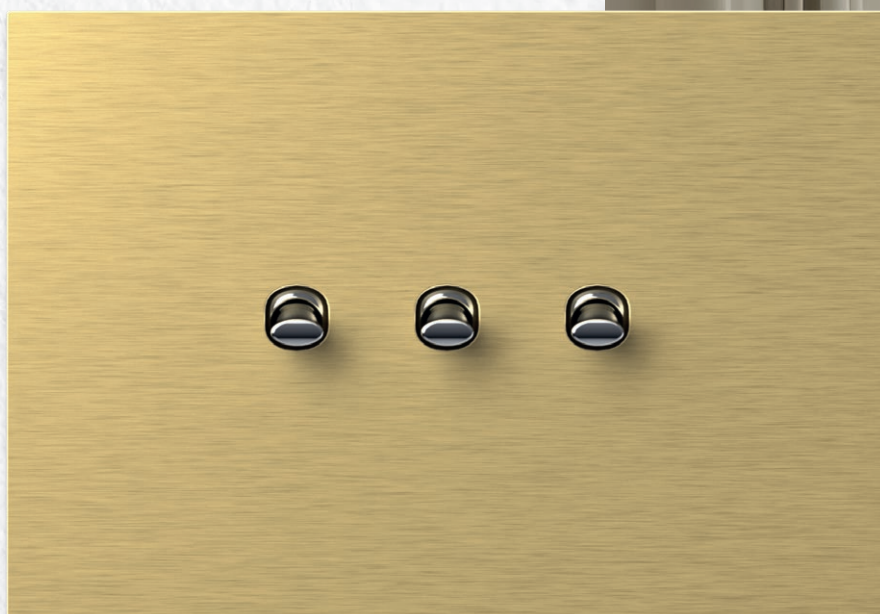

Nový prestížny rad, ktorý ponúka špeciálny zmyslový a vizuálny zážitok ako nikdy predtým.

The new prestigious product line offers a special sensory and visual experience like no other before. Are you bold enough?







MODUL

EDGE

PB



čierna

black

PA



antracitová

anthracite

PG



zlatá

gold

PC



chróm

chrome

kov
metal

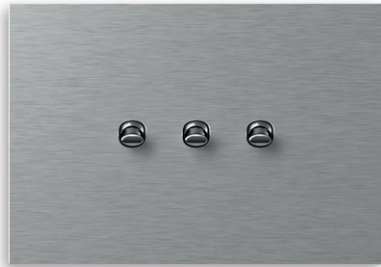

MA strieborná
silver

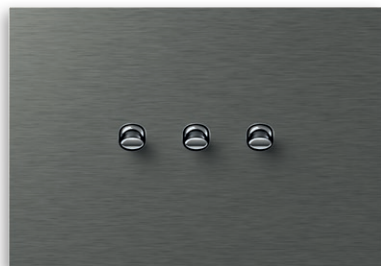
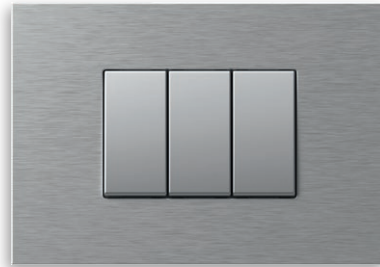

MT antracitová
anthracite

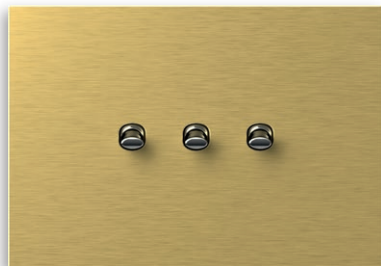
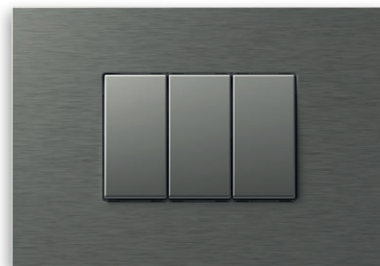

MZ zlatá
gold

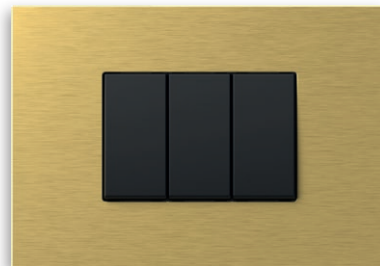

sklo
glass



GL biela
glass light

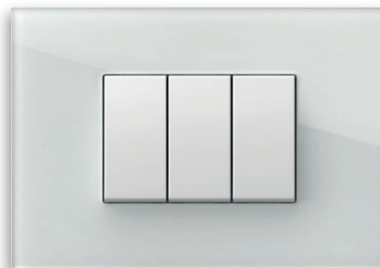

GD čierna
glass dark



MODUL
EDGE



Čistota skla umožňuje svetlu hrať a prejavíť sa v nových sklenených dekoratívnych rámkoch EDGE. Kontrastné farby uspokojia aj ten najsofistikovanejší vkus.

The purity of the glass allows the light to playfully manifest in the new EDGE glass decorative cover plates. The two contrast colours satisfy even the most sophisticated taste.





sklo
glass



GL biela
glass light



GD čierna
glass dark

MODUL
EDGE



Vďaka pôsobivému spracovaniu sa hliník leskne v novom svetle - kovových dekoratívnych rámkoch EDGE. V troch farebných prevedeniach hodných pozornosti.

Thanks to the impressive treatment, the aluminium shines with a new light – EDGE metal decorative cover plates. The three colours are worthy of your attention.





kov
metal



MA strieborná
silver

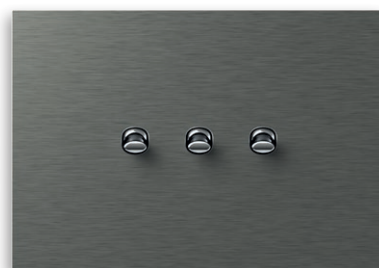

MT antracitová
anthracite

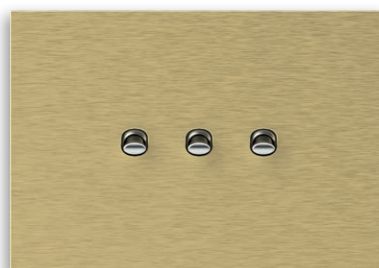

MZ zlatá
gold

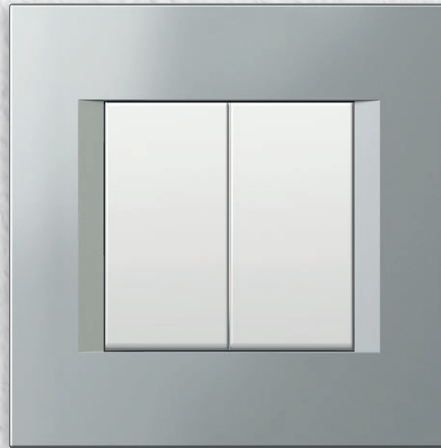

MODUL

-  LINE
-  SOFT
-  PURE
-  EDGE



+

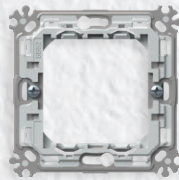

+



2M



2 x 2M



3 x 2M



4 x 2M



5 x 2M



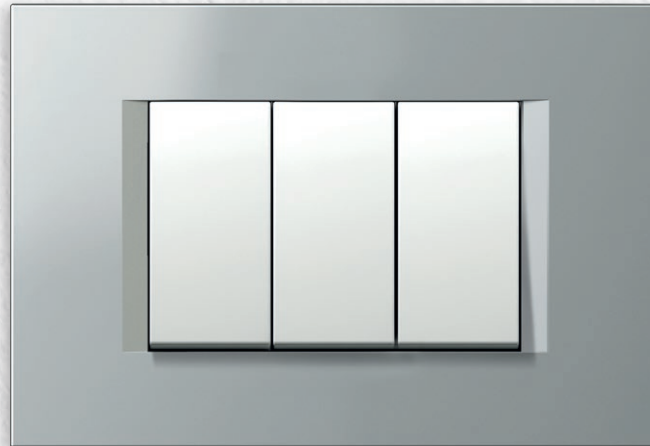

MODUL

- LINE
- SOFT
- PURE
- EDGE



2 x 7M

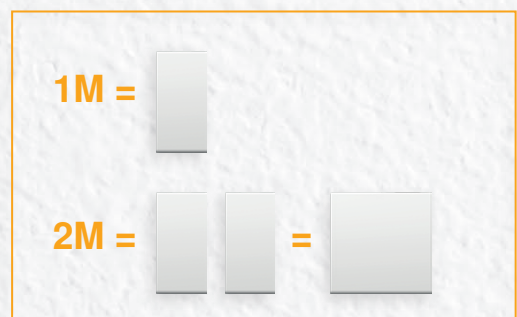

Funkčné prvky je možné ľahko namontovať do montážneho rámu. Vyvinuli sme pre vás riešenie typu „klik-in, klik-out“, aby sme vám skrátili celkovú dobu montáže. Pripojovacie kontakty sú ľahko prístupné z prednej strany.

The function elements are easily fitted inside the mounting frame.

The “klik-in, klik-out” solution we have developed for you will reduce installation time. The connection contacts are easily accessible from the front.

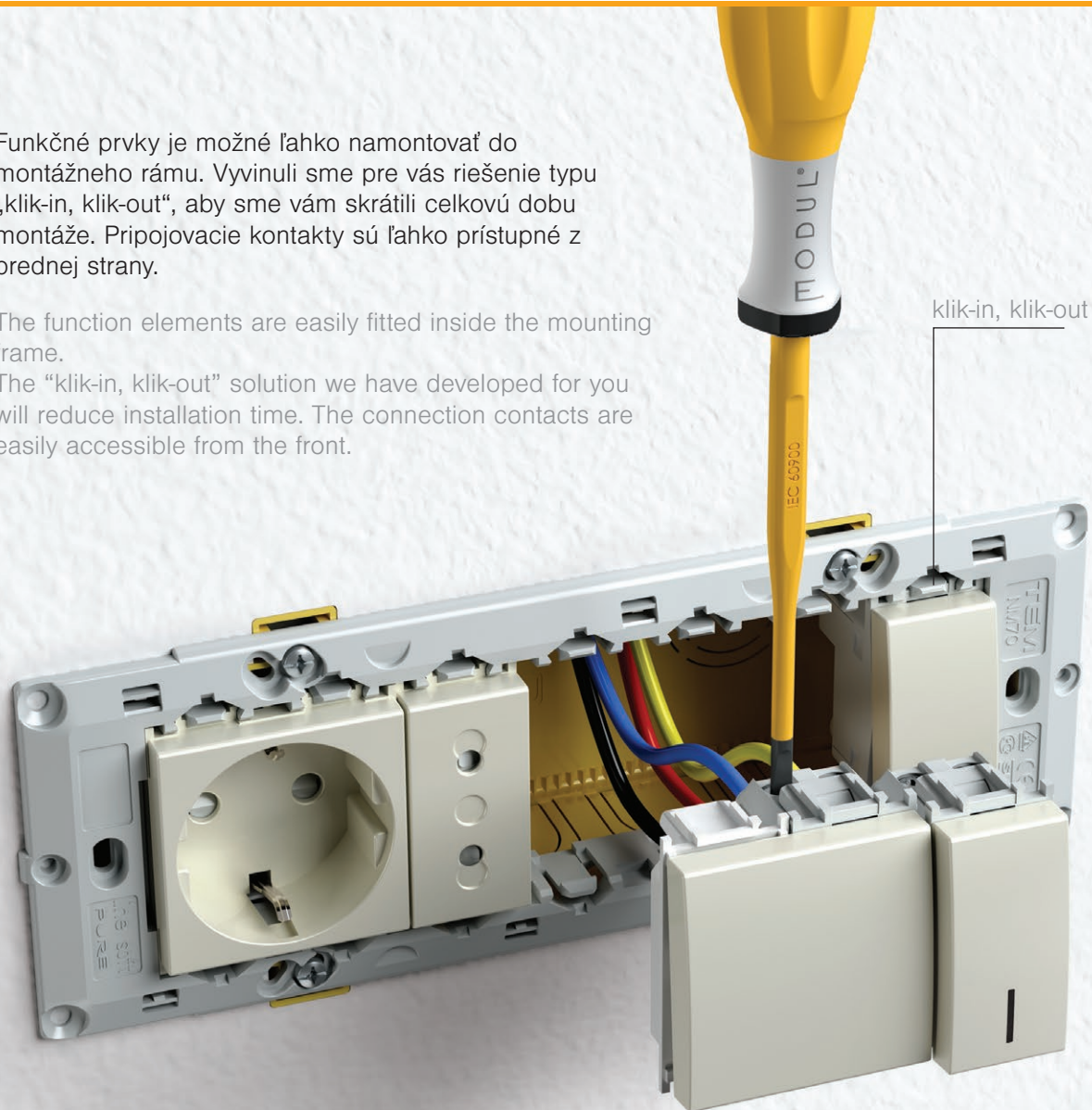

Rad Modul je vhodný pre všetky typy stien a môže byť použitý v konvenčných, betónových konštrukciách, ale aj v konštrukciách z dutých priečok. Ľahko sa inštaluje a umožňuje kombinovať obdĺžnikové alebo okrúhle krabice v správnych vzdialenostiach. Použité materiály sú v súlade s vysokými štandardmi.

The Modul is suitable for all wall types and can be used in conventional, hollow wall or concrete constructions. It is easy to install and enables you to combine rectangular or round boxes at the proper distances. The materials used are compliant with high standards.



tehla / brick



dutá priečka / hollow wall



betón / concrete

Modul vám ponúka veľa možností aj pri okrúhlych krabiciach. Možno ich kombinovať vodorovne alebo zvisle, jednotlivo alebo v skupinách. Kovový montážny rám zaručuje výbornú stabilitu aj pri drsnom používaní a je vhodný pre všetky dekoratívne rámičky.

The Modul enables a many possibilities even with round boxes. You can combine them horizontally or vertically, individually or in groups. The metal mounting frame ensures excellent stability even with rough use and is suitable for any decorative cover plates.

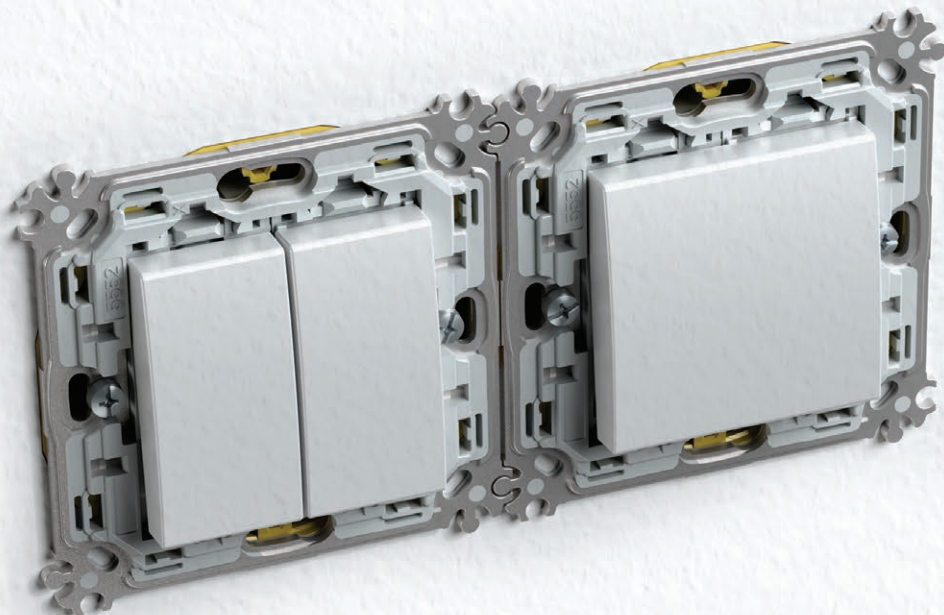



□ PW
biela lesklá
polar white



□ MW
biela matná
matte white



■ SB
čierna matná
soft touch black



■ AT
antracitová
anthracite



□ ES
strieborná matná
elox silver



□ IW
béžová lesklá
ivory white

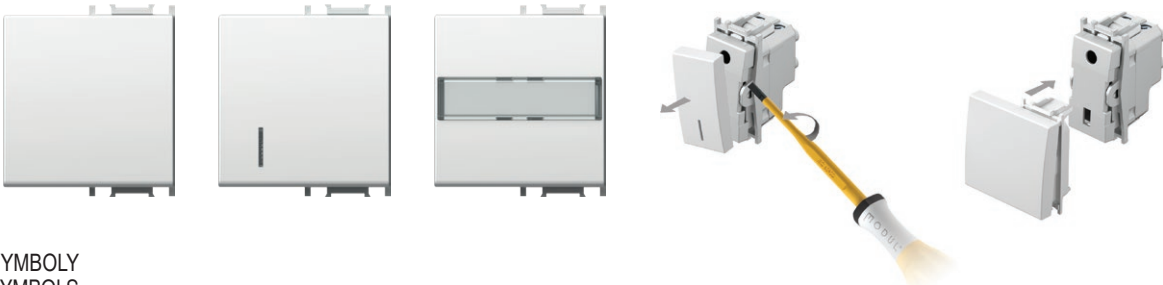

SYMBOLS SYMBOLS

01	02	03	04	05	06	07	08	09	10	11	12	13	14	20	21
22	23	24	25	26	27	28	29	30	31	32	33	34	35	36	37
38	39	40	41	42	43	44	45	46	47	48					

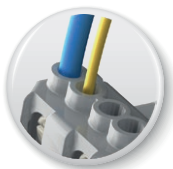
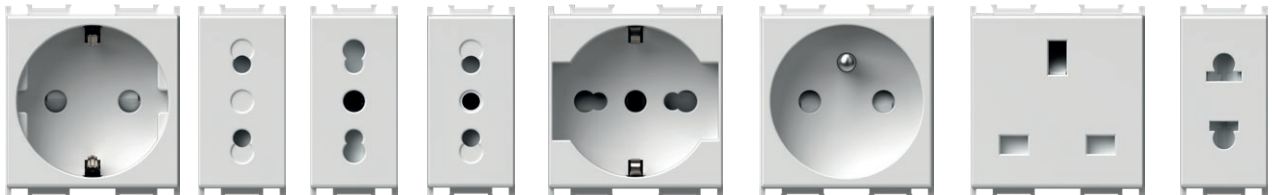

Spofahlivé pripojenie vodičov rôznych priemerov.

Reliable connection even when different size of wires are used.



Všetky zásuvky sú vybavené bezpečnostnou poistkou zabezpečujúcou ochranu pred dotykcom kontaktov pod napätím.

All the sockets are equipped with a safety shutters assuring the protection to live contacts.

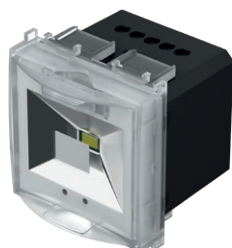
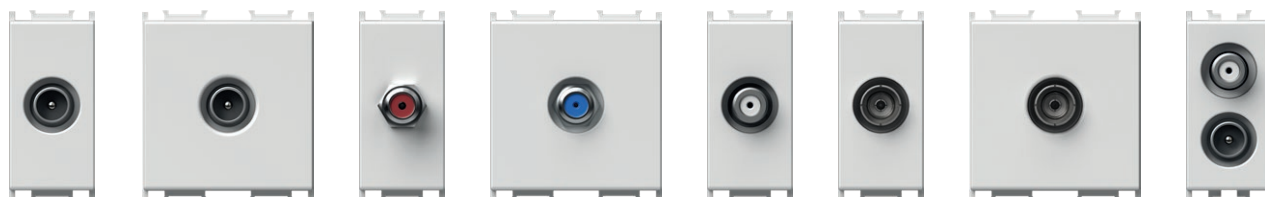
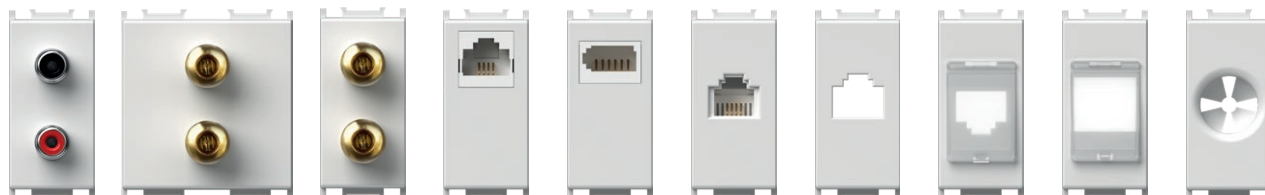

Dlhá životnosť spínačov a súlad s modernými normami.
Long-life of switches and adequacy to the international standards.



Spôľahlivosť prepínania umožňujú strieborné kontaktné nity.
The switch is highly reliable via its silver rivets contacts.

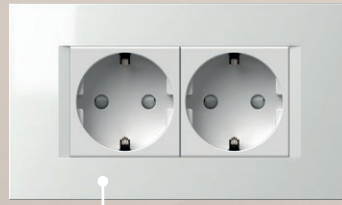
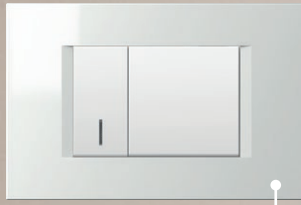



BIOPASS – spínač na odtlačky prstov

BIOPASS - fingerprint switch

Odomykanie bez kľúčov.

Keyless unlocking.

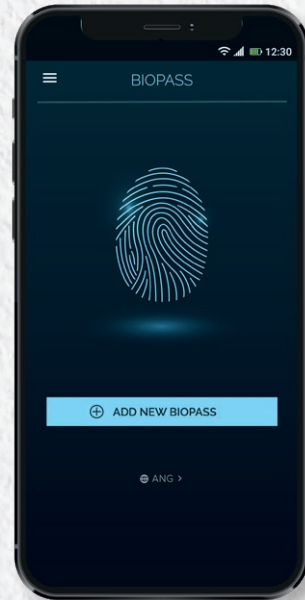

MULTIMÉDIÁ

MULTIMEDIA

Multimediálne centrum, ktoré vám ponúka možnosť prepojenia viacerých rôznych komponentov na jednom mieste.

Multimedia center that allows you to connect a multiple number of components in one place.



VYZDOB SI HO VLASTNÝM SPÔSOBOM

MAKE IT UNIQUE

Vyberte si farbu osvetlenia a pridajte požadovanú grafiku, aby vyhovovala vašej miestnosti.

Choose a illumination colour and add desired graphic to suit the ambience of your room.

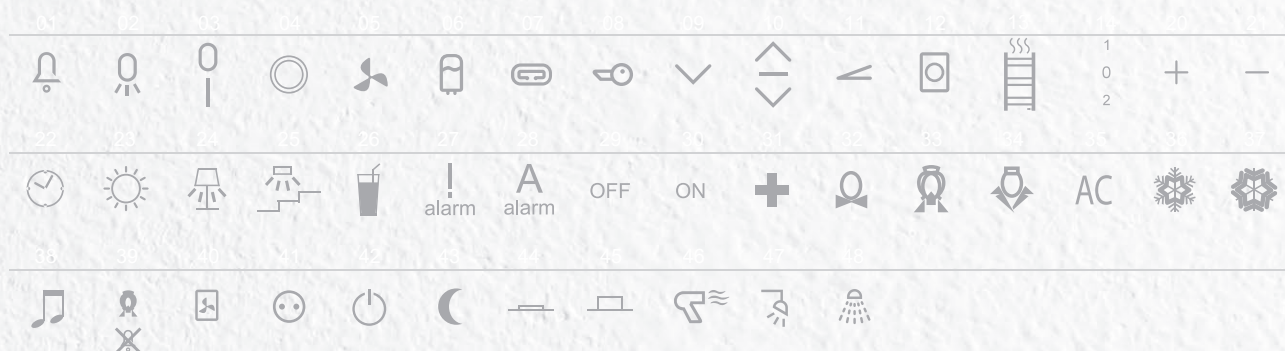

VYTVOR SI SVOJ CREATE YOUR OWN

Pri väčšom odbere vyrobíme rámičky a funkčné prvky vo farbe podľa vlastného výberu.

When ordering large quantities, cover plates and function elements can be made in the colour of your choice.

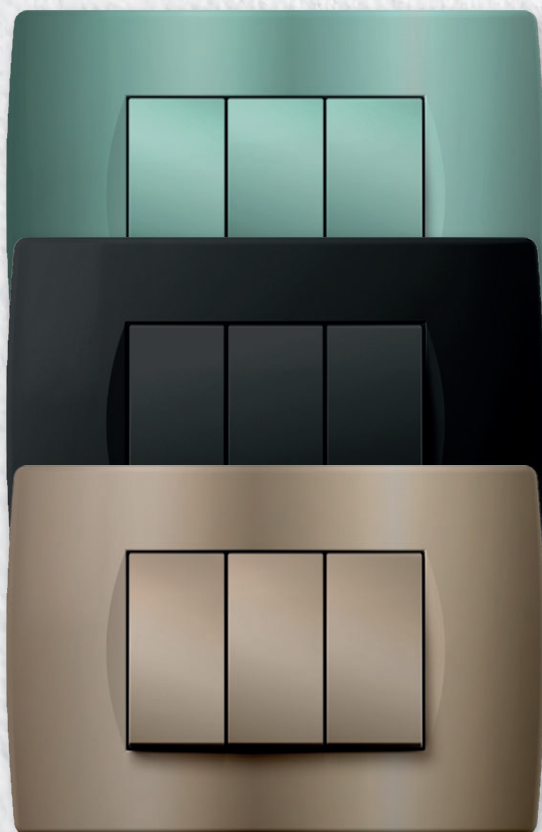



MULTIFUNKČNÝ ČASOVÝ SPÍNAČ

MULTIPURPOSE TIMER SWITCH

4 v 1

- Časovač
- Relé
- Tlačidlo
- Spínač

4 in 1

- timer
- relay
- push button
- switch





15'
ON/OFF

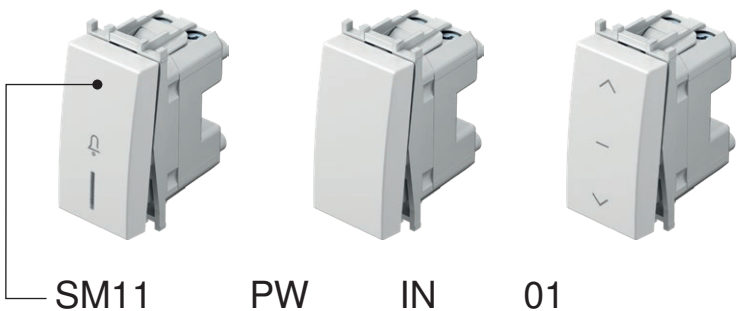

typ type	popis description	technické dáta technical data	veľkosť size	farba colour	voliteľné údaje 1 optional data 1	voliteľné údaje 2 optional data 2
SM10	SPÍNAČ JEDNOPÓLOVÝ SWITCH 1WAY	16AX 250V~	1M	<input type="checkbox"/> PW polárna biela polar white	<input type="checkbox"/> NT neutrálna neutral	01
SM11	TLAČIDLO JEDNOPÓLOVÉ PUSH BUTTON 1WAY	16A 250V~	1M	<input type="checkbox"/> MW biela matná matte white	<input type="checkbox"/> IN neutrálna indicator	02
SM12	SPÍNAČ JEDNOPÓLOVÝ SWITCH 1WAY	20A 250V~	1M	<input checked="" type="checkbox"/> SB čierna matná zamatová soft touch black		03
⋮	⋮	⋮	⋮	<input type="checkbox"/> AT antracit anthracite		
⋮	⋮	⋮	⋮	<input type="checkbox"/> ES čierna matná zamatová elox silver		
				<input type="checkbox"/> IW slonová kosť ivory white		

SPÍNAČ JEDNOPÓLOVÝ 16 AX 250 V ~ 1M



SM10



- spínač bez krytu tlačidla
 - 16 AX 250 V ~, typ SM10
 - v súlade s normou EN 60669-1
 - skrutkové upevnenie vodičov 1,5 – 2,5 mm²
- SWITCH 1WAY 16AX 250V~ 1M**
- switch without replaceable button
 - 16AX 250V~, type SM10
 - in accordance with EN 60669-1
 - screw contacts 1.5-2.5mm²

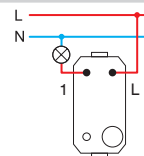

TLAČIDLO JEDNOPÓLOVÉ 16 AX 250 V ~ 1M



SM11



- tlačidlový spínač bez krytu tlačidla
 - 16 A 250 V ~, typ SM11
 - v súlade s normou EN 60669-1
 - skrutkové upevnenie vodičov 1,5 – 2,5 mm²
- PUSH BUTTON 1WAY 16A 250V~ 1M**
- push button without replaceable button
 - 16A 250V~, type SM11
 - in accordance with EN 60669-1
 - screw contacts 1.5-2.5mm²

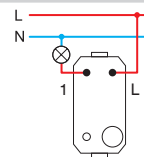

SPÍNAČ JEDNOPÓLOVÝ 20 A 250 V ~ 1M



SM12



- spínač bez krytu tlačidla
 - 20A 250 V ~, typ SM12
 - v súlade s normou EN 60669-1
 - skrutkové upevnenie vodičov 1,5 – 2,5 mm²
- SWITCH 1WAY 20A 250V~ 1M**
- switch without replaceable button
 - 20A 250V~, type SM12
 - in accordance with EN 60669-1
 - screw contacts 1.5-2.5mm²

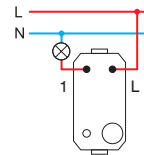

SPÍNAČ DVOJPÓLOVÝ 16 AX 250 V ~ 1M



SM20

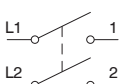

- spínač bez krytu tlačidla
 - 16 AX 250 V ~, typ SM20
 - v súlade s normou EN 60669-1
 - skrutkové upevnenie vodičov 1,5 – 2,5 mm²
 - len v kombinácii s tlačidlom TM15
- SWITCH 2POLE 16AX 250V~ 1M**
- switch without replaceable button
 - 16AX 250V~, type SM20
 - in accordance with EN 60669-1
 - screw contacts 1.5-2.5mm²
 - only in combination with button TM15

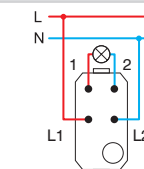

S W I T C H E S S M



SM40

ŽALÚZIOVÝ SPÍNAČ 1-0-2 16 AX 250 V ~ 1M

- spínač bez krytu tlačidla
- 16 AX 250 V ~, typ SM40
- v súlade s normou EN 60669-1
- skrutkové upevnenie vodičov 1,5 – 2,5 mm²

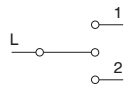

SWITCH SHUTTERS 1-0-2 16AX 250V~ 1M

- switch without replaceable button
- 16AX 250V~, type SM40
- in accordance with EN 60669-1
- screw contacts 1.5-2.5mm²

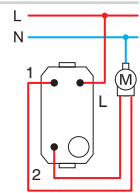

SM41

ŽALÚZIOVÉ TLAČIDLO 1-0-2 16 A 250 V ~ 1M

- tlačidlový spínač bez krytu tlačidla
- 16 A 250 V ~, typ SM41
- v súlade s normou EN 60669-1
- skrutkové upevnenie vodičov 1,5 – 2,5 mm²

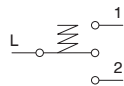

PUSH BUTTON SHUTTERS 1-0-2 16A 250V~ 1M

- push button without replaceable button
- 16A 250V~, type SM41
- in accordance with EN 60669-1
- screw contacts 1.5-2.5mm²

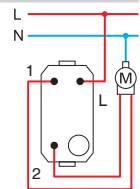

SM60

STRIEDAVÝ PREPÍNAČ 16 AX 250 V ~ 1M

- prepínač bez krytu tlačidla
- 16 AX 250 V ~, typ SM60
- v súlade s normou EN 60669-1
- skrutkové upevnenie vodičov 1,5 – 2,5 mm²

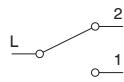

SWITCH 2WAY 16AX 250V~ 1M

- switch without replaceable button
- 16AX 250V~, type SM60
- in accordance with EN 60669-1
- screw contacts 1.5-2.5mm²

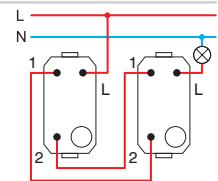

SM61

STRIEDAVÉ TLAČIDLO 16 A 250 V ~ 1M

- tlačidlový prepínač bez krytu tlačidla
- 16 A 250 V ~, typ SM61
- v súlade s normou EN 60669-1
- skrutkové upevnenie vodičov 1,5 – 2,5 mm²

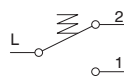

PUSH BUTTON 2WAY 16A 250V~ 1M

- push button without replaceable button
- 16A 250V~, type SM61
- in accordance with EN 60669-1
- screw contacts 1.5-2.5mm²

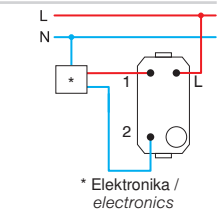

SM70

KRÍŽOVÝ PREPÍNAČ 16 AX 250 V ~ 1M

- prepínač bez krytu tlačidla
- 16 AX 250 V ~, typ SM70
- v súlade s normou EN 60669-1
- skrutkové upevnenie vodičov 1,5 – 2,5 mm²

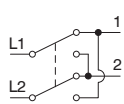

SWITCH INTERMEDIATE 16AX 250V~ 1M

- switch without replaceable button
- 16AX 250V~, type SM70
- in accordance with EN 60669-1
- screw contacts 1.5-2.5mm²

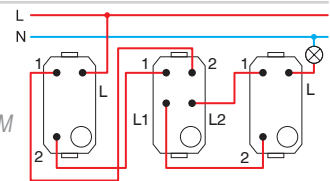

1M = 22,5 x 45
2M = 45 x 45

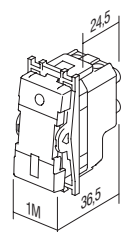
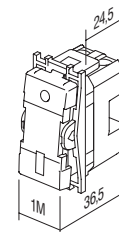



□ PW polárna biela
polar white
□ MW biela matná
matte white



■ SB čierna matná zamatová
soft touch black



■ AT antracit
anthracite



□ ES strieborná matná
elox silver



□ IW slonová kosť
ivory white

SPÍNAČ JEDNOPÓLOVÝ 16 AX 250 V ~ 1M

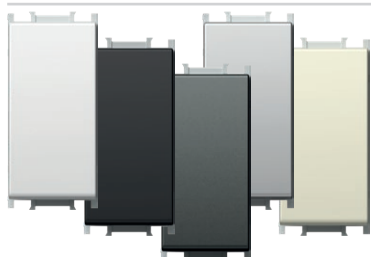

- SM10PW
- SM10MW
- SM10SB
- SM10AT
- SM10ES
- SM10IW

- 16 AX 250 V ~, typ SM10
- v súlade s normou EN 60669-1
- skrutkové upevnenie vodičov 1,5 – 2,5 mm²
- vymeniteľný kryt tlačidla

SWITCH 1WAY 16AX 250V~ 1M

- 16AX 250V~, type SM10
- in accordance with EN 60669-1
- screw contacts 1.5-2.5 mm²
- replaceable button



SPÍNAČ JEDNOPÓLOVÝ 16 AX 250 V ~ 1M __ IN



- SM10PWIN
- SM10MWIN
- SM10SBIN
- SM10ATIN
- SM10ESIN
- SM10IWIN

- indikátor IN
- 16 AX 250 V ~, typ SM10
- v súlade s normou EN 60669-1
- skrutkové upevnenie vodičov 1,5 – 2,5 mm²
- svetelný zdroj nie je zahrnutý
- vymeniteľný kryt tlačidla

SWITCH 1WAY 16AX 250V~ 1M __ IN

- IN indicator
- 16AX 250V~, type SM10
- in accordance with EN 60669-1
- screw contacts 1.5-2.5 mm²
- lamp is not included
- replaceable button



TLAČIDLO JEDNOPÓLOVÉ 16 A 250 V ~ 1M

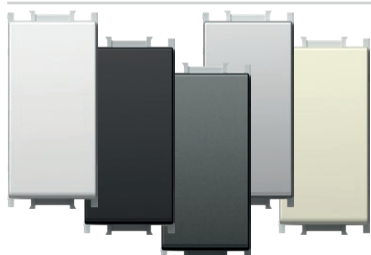

- SM11PW
- SM11MW
- SM11SB
- SM11AT
- SM11ES
- SM11IW

- 16 A 250 V ~, typ SM11
- v súlade s normou EN 60669-1
- skrutkové upevnenie vodičov 1,5 – 2,5 mm²
- vymeniteľný kryt tlačidla

PUSH BUTTON 1WAY 16A 250V~ 1M

- 16A 250V~, type SM11
- in accordance with EN 60669-1
- screw contacts 1.5-2.5 mm²
- replaceable button



TLAČIDLO JEDNOPÓLOVÉ 16 A 250 V ~ 1M __ IN 01



- SM11PWIN01
- SM11MWIN01
- SM11SBIN01
- SM11ATIN01
- SM11ESIN01
- SM11IWIN01

- zvonček indikátora IN 01
- 16 A 250 V ~, typ SM11
- v súlade s normou EN 60669-1
- skrutkové upevnenie vodičov 1,5 – 2,5 mm²
- svetelný zdroj nie je zahrnutý
- vymeniteľný kryt tlačidla

PUSH BUTTON 1WAY 16A 250V~ 1M __ IN 01

- IN 01 indicator bell
- 16A 250V~, type SM11
- in accordance with EN 60669-1
- screw contacts 1.5-2.5 mm²
- lamp is not included
- replaceable button



TLAČIDLO JEDNOPÓLOVÉ 16 A 250 V ~ 1M __ IN 02



- SM11PWIN02 - svetelný indikátor IN 02
- SM11MWIN02 - 16 A 250 V ~, typ SM11
- SM11SBIN02 - v súlade s normou EN 60669-1
- SM11ATIN02 - skrutkové upevnenie vodičov 1,5 – 2,5 mm²
- SM11ESIN02 - svetelný zdroj nie je zahrnutý
- SM11IWIN02 - vymeniteľný kryt tlačidla

PUSH BUTTON 1WAY 16A 250V~ 1M __ IN 02

- IN 02 indicator light
- 16A 250V~, type SM11
- in accordance with EN 60669-1
- screw contacts 1.5-2.5 mm²
- lamp is not included
- replaceable button



SPÍNAČ DVOJPÓLOVÝ 16 AX 250 V ~ 1M __ IN 03



- SM20PWNT03 - neutrál NT 03 0-1
- SM20MWNT03 - 16 AX 250 V ~, typ SM20
- SM20SBNT03 - v súlade s normou EN 60669-1
- SM20ATNT03 - skrutkové upevnenie vodičov 1,5 – 2,5 mm²
- SM20ESNT03 - vymeniteľný kryt tlačidla
- SM20IWNNT03

SWITCH 2POLE 16AX 250V~ 1M __ NT 03

- NT 03 neutral 0-1
- 16AX 250V~, type SM20
- in accordance with EN 60669-1
- screw contacts 1.5-2.5 mm²
- replaceable button



SPÍNAČ DVOJPÓLOVÝ 16 AX 250 V ~ 1M __ IN



- SM20PWIN - indikátor IN
- SM20MWIN - 16 AX 250 V ~, typ SM20
- SM20SBIN - v súlade s normou EN 60669-1
- SM20ATIN - skrutkové upevnenie vodičov 1,5 – 2,5 mm²
- SM20ESIN - svetelný zdroj nie je zahrnutý
- SM20IWIN - vymeniteľný kryt tlačidla

SWITCH 2POLE 16AX 250V~ 1M __ IN

- IN indicator
- 16AX 250V~, type SM20
- in accordance with EN 60669-1
- screw contacts 1.5-2.5 mm²
- lamp is not included
- replaceable button



ŽALÚZIOVÝ SPÍNAČ 1-0-2 16 AX 250 V ~ 1M __ NT 10

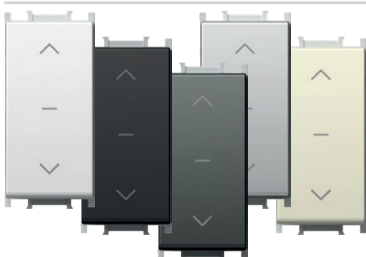

- SM40PWNT10 - neutrál NT 10 1-0-2
- SM40MWNT10 - 16 AX 250 V ~, typ SM40
- SM40SBNT10 - v súlade s normou EN 60669-1
- SM40ATNT10 - skrutkové upevnenie vodičov 1,5 – 2,5 mm²
- SM40ESNT10 - vymeniteľný kryt tlačidla
- SM40IWNNT10

SWITCH SHUTTERS 1-0-2 16AX 250V~ 1M __ NT 10

- NT 10 neutral 1-0-2
- 16AX 250V~, type SM40
- in accordance with EN 60669-1
- screw contacts 1.5-2.5mm²
- replaceable button



ŽALÚZIOVÉ TLAČIDLO 1-0-2 16 A 250 V ~ 1M __ NT 10

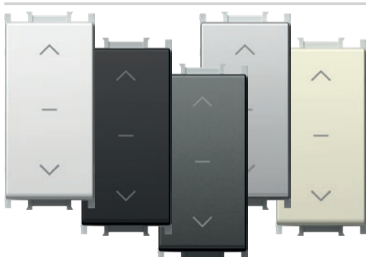

- SM41PWNT10 - neutrál NT 10 1-0-2
- SM41MWNT10 - 16 A 250 V ~, typ SM41
- SM41SBNT10 - v súlade s normou EN 60669-1
- SM41ATNT10 - skrutkové upevnenie vodičov 1,5 – 2,5 mm²
- SM41ESNT10 - vymeniteľný kryt tlačidla
- SM41IWNNT10

PUSH BUTTON SHUTTERS 1-0-2 16A 250V~ 1M __ NT 10

- NT 10 neutral 1-0-2
- 16A 250V~, type SM41
- in accordance with EN 60669-1
- screw contacts 1.5-2.5mm²
- replaceable button



STRIEDAVÝ PREPÍNAČ 16 AX 250 V ~ 1M

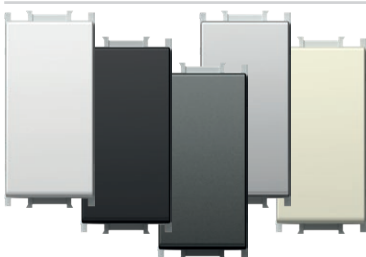

- SM60PW - 16 AX 250 V ~, typ SM60
- SM60MW - v súlade s normou EN 60669-1
- SM60SB - skrutkové upevnenie vodičov 1,5 – 2,5 mm²
- SM60AT - vymeniteľný kryt tlačidla
- SM60ES
- SM60IW

SWITCH 2WAY 16AX 250V~ 1M

- 16AX 250V~, type SM60
- in accordance with EN 60669-1
- screw contacts 1.5-2.5 mm²
- replaceable button



STRIEDAVÉ TLAČIDLO 16 A 250 V ~ 1M

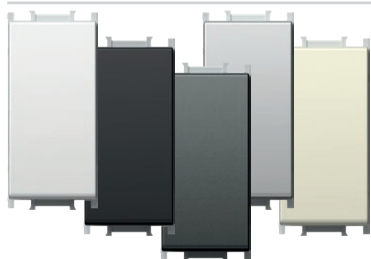

- SM61PW
- SM61MW
- SM61SB
- SM61AT
- SM61ES
- SM61IW

- 16 A 250 V ~, typ SM61
- v súlade s normou EN 60669-1
- skrutkové upevnenie vodičov 1,5 – 2,5 mm²
- vymeniteľný kryt tlačidla

PUSH BUTTON 2WAY 16A 250V~ 1M

- 16A 250V~, type SM61
- in accordance with EN 60669-1
- screw contacts 1.5-2.5 mm²
- replaceable button



STRIEDAVÉ TLAČIDLO S TIAHLOM 16 A 250 V ~ 1M __ CD



- SM62PWCD
- SM62MWCD
- SM62SBCD
- SM62ATCD
- SM62ESCD
- SM62IWCD

- indikátor CD + kábel
- dĺžka tiahla 1,5 m
- 16 A 250 V ~, typ SM62
- v súlade s normou EN 60669-1
- skrutkové upevnenie vodičov 1,5 – 2,5 mm²

PUSH BUTTON 2WAY WITH CORD 16A 250V~ 1M __ CD

- CD indicator+cord
- cord length 1.5m
- 16A 250V~, type SM62
- in accordance with EN 60669-1
- screw contacts 1.5-2.5 mm²



KRÍŽOVÝ PREPÍNAČ 16 AX 250 V ~ 1M



- SM70PW
- SM70MW
- SM70SB
- SM70AT
- SM70ES
- SM70IW

- 16 AX 250 V ~, typ SM70
- v súlade s normou EN 60669-1
- skrutkové upevnenie vodičov 1,5 – 2,5 mm²
- vymeniteľný kryt tlačidla

SWITCH INTERMEDIATE 16AX 250V~ 1M

- 16AX 250V~, type SM70
- in accordance with EN 60669-1
- screw contacts 1.5-2.5 mm²
- replaceable button



1M = 22,5 x 45
2M = 45 x 45

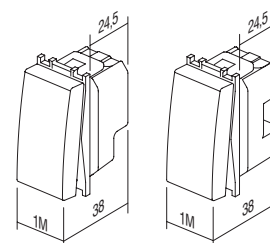

B U T T O N S T M

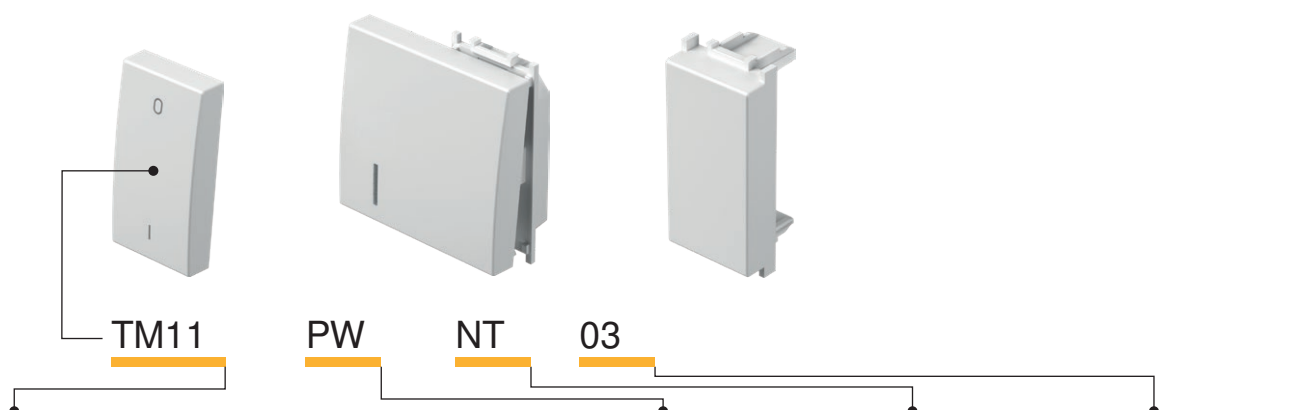

typ type	popis description	veľkosť size	farba colour	voliteľné údaje 1 optional data 1	voliteľné údaje 2 optional data 2
TM11	KRYT TLAČIDLA BUTTON	1M	<input type="checkbox"/> PW polárna biela polar white <input type="checkbox"/> MW biela matná matte white <input checked="" type="checkbox"/> SB čierna matná zamatová soft touch black <input type="checkbox"/> AT antracit anthracite <input type="checkbox"/> ES čierna matná zamatová elox silver <input type="checkbox"/> IW slonová kosť ivory white	NT neutrálna neutral IN indikátor indicator	01 02 03
TM12	KRYT TLAČIDLA BUTTON	2M			
TM21	VÝPLŇ BLANK	1M			
.	.	.			
.	.	.			

KRYT TLAČIDLA 1M



- TM11PW
- TM11MW
- TM11SB
- TM11AT
- TM11ES
- TM11IW

- vymeniteľný kryt tlačidla 1M
- v súlade s normou EN 60669-1

BUTTON 1M

- replaceable button 1M
- in accordance with EN 60669-1



KRYT TLAČIDLA S INDIKÁTOROM 1M



- TM11PWIN
- TM11MWIN
- TM11SBIN
- TM11ATIN
- TM11ESIN
- TM11IWIN

- vymeniteľný kryt tlačidla 1M
- v súlade s normou EN 60669-1

BUTTON 1M INDICATOR

- replaceable button 1M
- in accordance with EN 60669-1



KRYT TLAČIDLA 2M

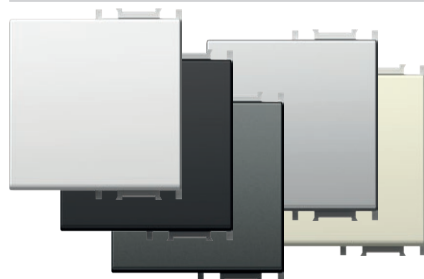

- TM12PW
- TM12MW
- TM12SB
- TM12AT
- TM12ES
- TM12IW

- vymeniteľný kryt tlačidla 2M
- pri zmene vypínača alebo tlačidla z 1M na 2M veľkosť
- v súlade s normou EN 60669-1

BUTTON 2M

- replaceable button 2M with button carrier
- to upgrade switch or push button from size 1M to size 2M
- in accordance with EN 60669-1



KRYT TLAČIDLA S INDIKÁTOROM 2M

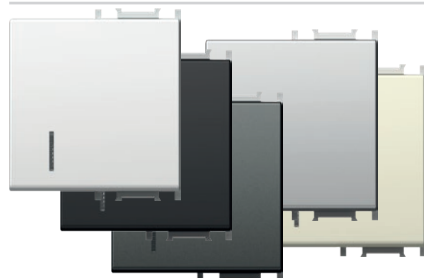

- TM12PWIN
- TM12MWIN
- TM12SBIN
- TM12ATIN
- TM12ESIN
- TM12IWIN

- vymeniteľný kryt tlačidla 2M
- pri zmene vypínača alebo tlačidla z 1M na 2M veľkosť
- v súlade s normou EN 60669-1

BUTTON 2M INDICATOR

- replaceable button 2M with button carrier
- to upgrade switch or push button from size 1M to size 2M
- in accordance with EN 60669-1



KRYT NA SPÍNAČ S POPISNÝM ŠTÍTKOM

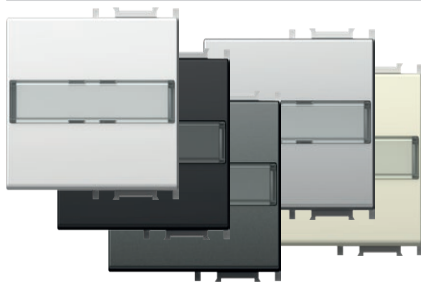

- TM13PWIL
- TM13MWIL
- TM13SBIL
- TM13ATIL
- TM13ESIL
- TM13IWIL

- vymeniteľné tlačidlo 2M s úchytkou tlačidla
 - pri zmene vypínača alebo tlačidla
 z 1M na 2M veľkosť
 - v súlade s normou EN 60669-1

BUTTON 2M WITH INSCRIPTION PLATE
 - replaceable button 2M with button carrier
 - to upgrade switch or push button
 from size 1M to size 2M
 - in accordance with EN 60669-1



KRYT NA SPÍNAČ DVOJPÓLOVÝ



- TM15PW
- TM15MW
- TM15SB
- TM15AT
- TM15ES
- TM15IW

- vymeniteľné tlačidlo 1M
 - len v kombinácii s mechanizmom SM20
 - v súlade s normou EN 60669-1

BUTTON 1M 2POLE
 - replaceable button 1M
 - only in combination with mechanism SM20
 - in accordance with EN 60669-1



VÝPLŇ 1M



- TM21PW
- TM21MW
- TM21SB
- TM21AT
- TM21ES
- TM21IW

- výplňový modul na zaplnenie prázdnych miest
 - v súlade s normou EN 60669-1

BLANK 1M
 - blank modul to fill up empty spaces
 - in accordance with EN 60669-1



VÝPLŇ 2M

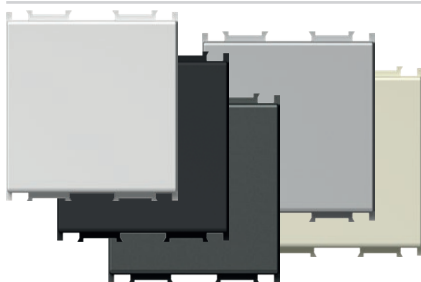

- TM22PW
- TM22MW
- TM22SB
- TM22AT
- TM22ES
- TM22IW

- výplňový modul na zaplnenie prázdnych miest
 - v súlade s normou EN 60669-1

BLANK 2M
 - blank modul to fill up empty spaces
 - in accordance with EN 60669-1



KÁBLOVÁ PRECHODKA 1M

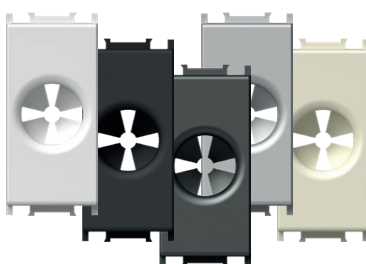

- TM31PW
- TM31MW
- TM31SB
- TM31AT
- TM31ES
- TM31IW

- vývod na kábel
 - v súlade s normou EN-60669-1

CABLE OUTLET 1M
 - outlet for cable
 - in accordance with EN-60669-1



1M = 22,5 x 45
 2M = 45 x 45



TM11
 TM15

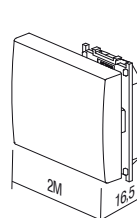

TM12
 TM13

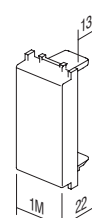

TM21

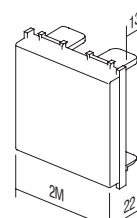

TM22

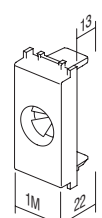

TM31

BUTTONS T M

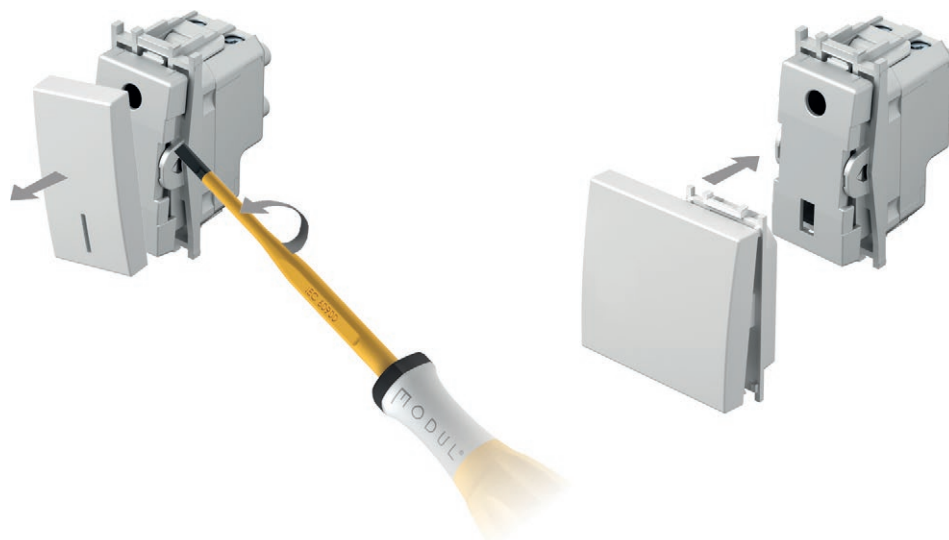

LASEROVÁ POTLAČ KRYTOV TLAČIDIEL

- laserová tlač akejkoľvek grafiky na vyznačených miestach
- štandardné symboly z ponuky, ostatné na vyziadanie

LASER PRINT ON BUTTONS

- laser print of any graphics on marked locations
- standard symbols from stock, other on request

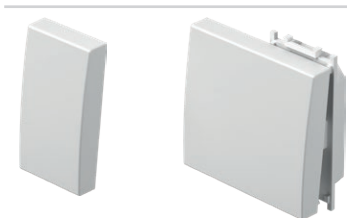

1M

A
B
C

2M

A	D	G
B	E	H
C	F	I

SYMBOLY

SYMBOLS

01	02	03	04	05	06	07	08	09	10	11	12	13	14	20	21
													1 0 2	+	-
22	23	24	25	26	27	28	29	30	31	32	33	34	35	36	37
					alarm	alarm	OFF	ON	+				AC		
38	39	40	41	42	43	44	45	46	47	48					

ŠTANDARDNÉ SYMBOLY

STANDARD SYMBOLS

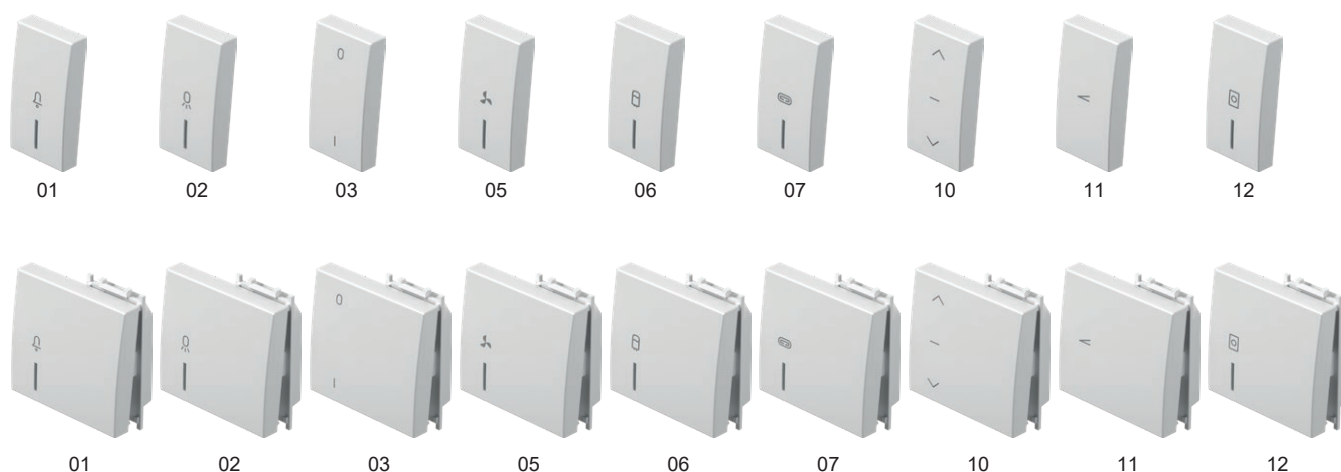

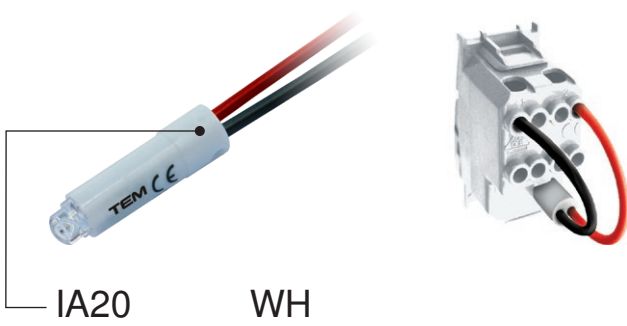

typ type	popis description	technické dáta technical data	farba colour
IA10	TLEJIVKA NEON LAMP	230V~ 0,34W	<input type="checkbox"/> WH biela white
IA20	LED SIGNALIZÁCIA LED SIGNALLING UNIT	230V~ AC/DC 0,40W	<input checked="" type="checkbox"/> BL modrá blue
IA21	LED SIGNALIZÁCIA LED SIGNALLING UNIT	24V AC/DC 0,20W	<input checked="" type="checkbox"/> RD červená red
·	·	·	<input checked="" type="checkbox"/> GR zelená green
·	·	·	<input checked="" type="checkbox"/> OR oranžová orange

TLEJIVKA 230 V ~ 0,34 W

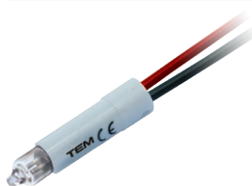

IA10OR

- na indikáciu, signalizáciu alebo trvalú signalizáciu
- v kombinácii s tlačidlom s indikátorom

NEON LAMP 230V~ 0,34W

- for indication, signalling or permanent signalling
- in combination with a button featuring an indicator

LED SIGNALIZÁCIA 230 V AC/DC 0,40 W

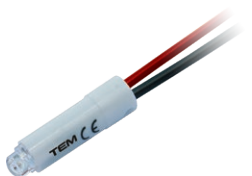

- IA20WH
- IA20GR
- IA20RD
- IA20BL

- na indikáciu, signalizáciu alebo trvalú signalizáciu
- v kombinácii s tlačidlom s indikátorom

LED SIGNALLING UNIT 230V AC/DC 0,40W

- for indication, signalling or permanent signalling
- in combination with a button featuring an indicator

LED SIGNALIZÁCIA 24 V AC/DC 0,20 W

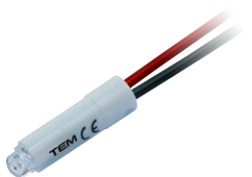

- IA21WH
- IA21RD

- na indikáciu, signalizáciu alebo trvalú signalizáciu
- v kombinácii s tlačidlom s indikátorom

LED SIGNALLING UNIT LAMP 24V AC/DC 0,20W

- for indication, signalling or permanent signalling
- in combination with a button featuring an indicator

LED SIGNALIZÁCIA 12 V AC/DC 0,10 W

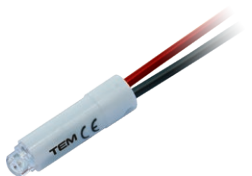

- IA22WH
- IA22RD

- na indikáciu, signalizáciu alebo trvalú signalizáciu
- v kombinácii s tlačidlom s indikátorom

LED SIGNALLING UNIT 12V AC/DC 0,10W

- for indication, signalling or permanent signalling
- in combination with a button featuring an indicator

RC OBVOD 250V~



IA50

- RC obvod na odstránenie rušenia v prevádzke LED svietidiel
- sú možné paralelné zapojenia viacerých RC obvodov so svietidlami
- 0,1 µF, 100 Ω, 250V~

RC CIRCUIT 250V~

- RC circuit to eliminate disturbances in the operation of LED lamps
- parallel connections of more RC circuits with lamps are possible
- 0,1 µF, 100 Ω, 250V~

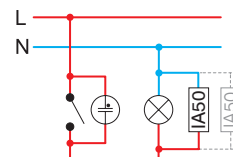

S I G N A L I Z A T I O N I A

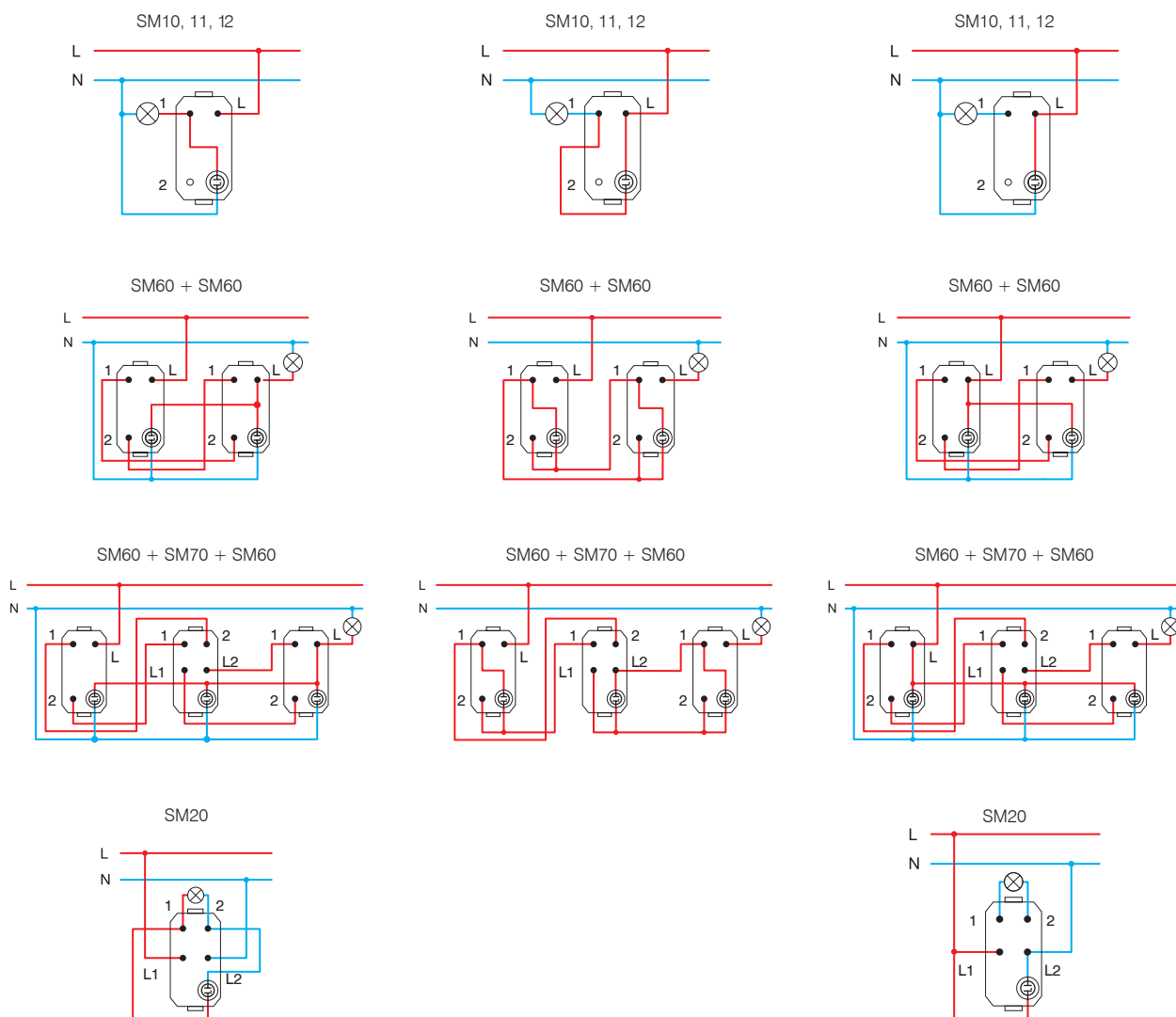
Indikácia /
Indication* Signalizácia /
SignalizationTrvalá signalizácia /
Permanent signalling

* pripojenia nie sú vhodné pre úsporné žiarivky (CFL, LED) /
the connections are not suitable for energy-saving bulbs (CFL, LED)

1M = 22,5 x 45
2M = 45 x 45

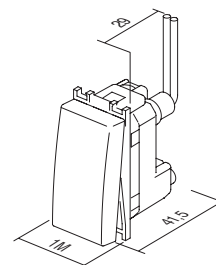

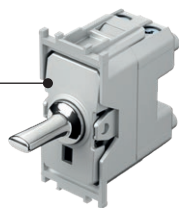

SP10

PC

typ type	názov description	technický popis technical data	veľkosť size	farba kolíkov pin colour
SP10	SPÍNAČ JEDNOPÓLOVÝ SWITCH 1WAY	16AX 250V~	1M	PC chrómová chrome
SP11	TLAČIDLO JEDNOPÓLOVÉ PUSH BUTTON 1WAY	16A 250V~	1M	PA antracitová anthracite
SP12	SPÍNAČ JEDNOPÓLOVÝ SWITCH 1WAY	20A 250V~	1M	PB čierna black
·	·	·	·	PG zlatá gold

SPÍNAČ JEDNOPÓLOVÝ 16AX 250 V~ 1M



- SP10PC
- SP10PA
- SP10PB
- SP10PG

- spínač
- 16AX 250 V~, typ SP10
- v súlade s normou EN 60669-1
- bezskrútkové upevnenie vodičov 1,5 – 2,5 mm²
SWITCH 1WAY 16AX 250V~ 1M
- switch
- 16AX 250V~, type SP10
- in accordance with EN 60669-1
- screw contacts 1.5-2.5mm²

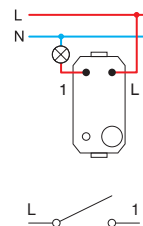

TLAČIDLO JEDNOPÓLOVÉ 16A 250 V~ 1M



- SP11PC
- SP11PA
- SP11PB
- SP11PG

- tlačidlo
- 16A 250 V~, typ SP11
- v súlade s normou EN 60669-1
- bezskrútkové upevnenie vodičov 1,5 – 2,5 mm²
PUSH BUTTON 1WAY 16A 250V~ 1M
- push button
- 16A 250V~, type SP11
- in accordance with EN 60669-1
- screw contacts 1.5-2.5mm²

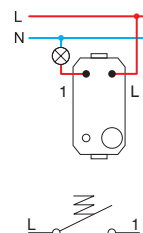

SPÍNAČ JEDNOPÓLOVÝ 20A 250 V~ 1M



- SP12PC
- SP12PA
- SP12PB
- SP12PG

- spínač
- 20A 250 V~, typ SP12
- v súlade s normou EN 60669-1
- bezskrútkové upevnenie vodičov 1,5 – 2,5 mm²
SWITCH 1WAY 20A 250V~ 1M
- switch
- 20A 250V~, type SP12
- in accordance with EN 60669-1
- screw contacts 1.5-2.5mm²

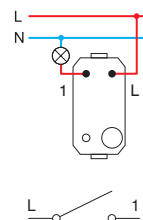

SPÍNAČ DVOJPÓLOVÝ 16AX 250 V~ 1M



- SP20PC
- SP20PA
- SP20PB
- SP20PG

- spínač
- 16AX 250 V~, typ SP20
- v súlade s normou EN 60669-1
- bezskrútkové upevnenie vodičov 1,5 – 2,5 mm²
SWITCH 2POLE 16AX 250V~ 1M
- switch
- 16AX 250V~, type SP20
- in accordance with EN 60669-1
- screw contacts 1.5-2.5mm²

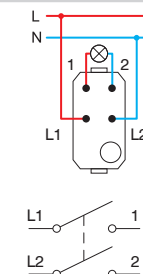



- SP40PC
- SP40PA
- SP40PB
- SP40PG

SPÍNAČ ŽALÚZIOVÝ 1-0-2 16AX 250 V~ 1M

- spínač
 - 16AX 250 V~, typ SP40
 - v súlade s normou EN 60669-1
 - bezskrútkové upevnenie vodičov 1,5 – 2,5 mm²
- SWITCH SHUTTERS 1-0-2 16AX 250V~ 1M*
- switch
 - 16AX 250V~, type SP40
 - in accordance with EN 60669-1
 - screw contacts 1.5-2.5mm²

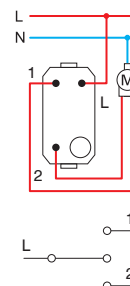

- SP41PC
- SP41PA
- SP41PB
- SP41PG

TLAČIDLO ŽALÚZIOVÉ 1-0-2 16 A 250 V~ 1M

- tlačidlo
 - 16A 250 V~, typ SP41
 - v súlade s normou EN 60669-1
 - bezskrútkové upevnenie vodičov 1,5 – 2,5 mm²
- PUSH BUTTON SHUTTERS 1-0-2 16A 250V~ 1M*
- push button
 - 16A 250V~, type SP41
 - in accordance with EN 60669-1
 - screw contacts 1.5-2.5mm²

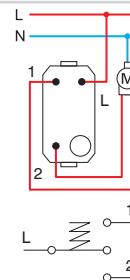

- SP60PC
- SP60PA
- SP60PB
- SP60PG

SPÍNAČ STRIEDAVÝ 16AX 250 V~ 1M

- spínač
 - 16AX 250 V~, typ SP60
 - v súlade s normou EN 60669-1
 - bezskrútkové upevnenie vodičov 1,5 – 2,5 mm²
- SWITCH 2WAY 16AX 250V~ 1M*
- switch
 - 16AX 250V~, type SP60
 - in accordance with EN 60669-1
 - screw contacts 1.5-2.5mm²

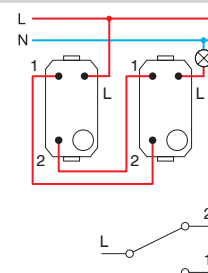

- SP61PC
- SP61PA
- SP61PB
- SP61PG

TLAČIDLO STRIEDAVÉ 16A 250 V~ 1M

- tlačidlo
 - 16A 250 V~, typ SP61
 - v súlade s normou EN 60669-1
 - bezskrútkové upevnenie vodičov 1,5 – 2,5 mm²
- PUSH BUTTON 2WAY 16A 250V~ 1M*
- push button
 - 16A 250V~, type SP61
 - in accordance with EN 60669-1
 - screw contacts 1.5-2.5mm²

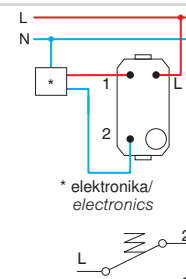

- SP70PC
- SP70PA
- SP70PB
- SP70PG

SPÍNAČ KRIŽOVÝ 16AX 250 V~ 1M

- spínač
 - 16AX 250 V~, typ SP70
 - v súlade s normou EN 60669-1
 - bezskrútkové upevnenie vodičov 1,5 – 2,5 mm²
- SWITCH INTERMEDIATE 16AX 250V~ 1M*
- switch
 - 16AX 250V~, type SP70
 - in accordance with EN 60669-1
 - screw contacts 1.5-2.5mm²

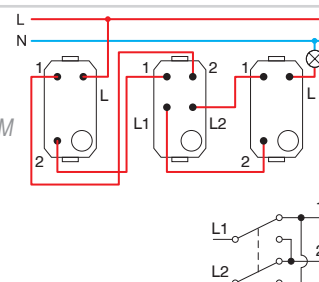

1M= 22,5 x 45

- SP10
- SP11
- SP12
- SP40
- SP41
- SP60
- SP61

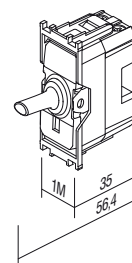

- SP20
- SP70

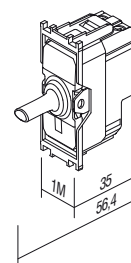

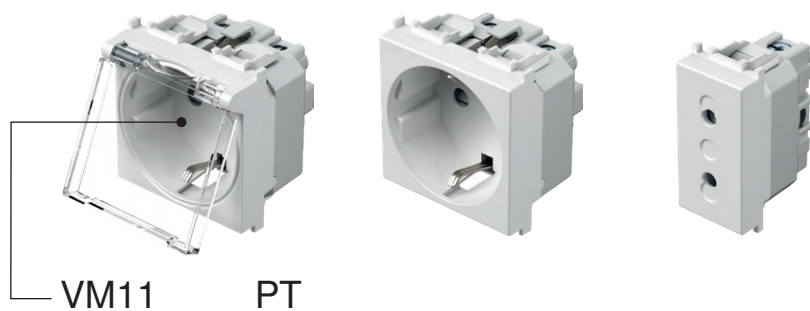

VM11

PT

typ type	popis description	technické dáta technical data	veľkosť size	farba colour																																										
VM10	ZÁSUVKA SCHUKO + KS SOCKET SCHUKO+KS	2P+E 16A 250V~	2M	<table border="0"> <tr> <td><input type="checkbox"/> PW</td> <td>polárna biela polar white</td> <td><input checked="" type="checkbox"/> PT</td> <td>biela + transparentná white+transparent</td> <td><input type="checkbox"/> PP</td> <td>biela + biela white+white</td> </tr> </table>	<input type="checkbox"/> PW	polárna biela polar white	<input checked="" type="checkbox"/> PT	biela + transparentná white+transparent	<input type="checkbox"/> PP	biela + biela white+white																																				
<input type="checkbox"/> PW	polárna biela polar white	<input checked="" type="checkbox"/> PT	biela + transparentná white+transparent	<input type="checkbox"/> PP	biela + biela white+white																																									
VM11	ZÁSUVKA SCHUKO + KS + KRYT SOCKET SCHUKO+KS+COVER	2P+E 16A 250V~	2M	<table border="0"> <tr> <td><input type="checkbox"/> MW</td> <td>biela matná matte white</td> <td><input checked="" type="checkbox"/> MT</td> <td>biela + transparentná white+transparent</td> <td><input type="checkbox"/> MM</td> <td>biela + biela white+white</td> </tr> </table>	<input type="checkbox"/> MW	biela matná matte white	<input checked="" type="checkbox"/> MT	biela + transparentná white+transparent	<input type="checkbox"/> MM	biela + biela white+white																																				
<input type="checkbox"/> MW	biela matná matte white	<input checked="" type="checkbox"/> MT	biela + transparentná white+transparent	<input type="checkbox"/> MM	biela + biela white+white																																									
VM20	ZÁSUVKA EURO + KS SOCKET EURO+KS	2P 10A 250V~	1M	<table border="0"> <tr> <td><input checked="" type="checkbox"/> SB</td> <td>čierna matná soft touch black</td> <td><input checked="" type="checkbox"/> BT</td> <td>čierna + transparentná soft touch black+transparent</td> <td><input checked="" type="checkbox"/> BB</td> <td>čierna matná + čierna matná soft touch black+black</td> </tr> <tr> <td><input checked="" type="checkbox"/> AT</td> <td>antracit anthracite</td> <td><input checked="" type="checkbox"/> AT</td> <td>antracit + transparentná anthracite+transparent</td> <td><input checked="" type="checkbox"/> AA</td> <td>antracit + antracit anthracite+anthracite</td> </tr> <tr> <td><input checked="" type="checkbox"/> ES</td> <td>strieborná elox silver</td> <td><input checked="" type="checkbox"/> ST</td> <td>strieborná + transparentná silver+transparent</td> <td><input checked="" type="checkbox"/> SS</td> <td>strieborná + strieborná silver+silver</td> </tr> <tr> <td><input checked="" type="checkbox"/> IW</td> <td>slonová kosť ivory white</td> <td><input checked="" type="checkbox"/> IT</td> <td>slonová kosť + transparentná ivory+transparent</td> <td><input checked="" type="checkbox"/> II</td> <td>slonová kosť + slonová kosť ivory+ivory</td> </tr> <tr> <td><input checked="" type="checkbox"/> RD</td> <td>červená red</td> <td><input checked="" type="checkbox"/> RT</td> <td>červená + transparentná red+transparent</td> <td><input checked="" type="checkbox"/> RR</td> <td>červená + červená red+red</td> </tr> <tr> <td><input checked="" type="checkbox"/> GR</td> <td>zelená green</td> <td><input checked="" type="checkbox"/> GT</td> <td>zelená + transparentná green+transparent</td> <td><input checked="" type="checkbox"/> GG</td> <td>zelená + zelená green+green</td> </tr> <tr> <td><input checked="" type="checkbox"/> OR</td> <td>oranžová orange</td> <td><input checked="" type="checkbox"/> OT</td> <td>oranžová + transparentná orange+transparent</td> <td><input checked="" type="checkbox"/> OO</td> <td>oranžová + oranžová orange+orange</td> </tr> </table>	<input checked="" type="checkbox"/> SB	čierna matná soft touch black	<input checked="" type="checkbox"/> BT	čierna + transparentná soft touch black+transparent	<input checked="" type="checkbox"/> BB	čierna matná + čierna matná soft touch black+black	<input checked="" type="checkbox"/> AT	antracit anthracite	<input checked="" type="checkbox"/> AT	antracit + transparentná anthracite+transparent	<input checked="" type="checkbox"/> AA	antracit + antracit anthracite+anthracite	<input checked="" type="checkbox"/> ES	strieborná elox silver	<input checked="" type="checkbox"/> ST	strieborná + transparentná silver+transparent	<input checked="" type="checkbox"/> SS	strieborná + strieborná silver+silver	<input checked="" type="checkbox"/> IW	slonová kosť ivory white	<input checked="" type="checkbox"/> IT	slonová kosť + transparentná ivory+transparent	<input checked="" type="checkbox"/> II	slonová kosť + slonová kosť ivory+ivory	<input checked="" type="checkbox"/> RD	červená red	<input checked="" type="checkbox"/> RT	červená + transparentná red+transparent	<input checked="" type="checkbox"/> RR	červená + červená red+red	<input checked="" type="checkbox"/> GR	zelená green	<input checked="" type="checkbox"/> GT	zelená + transparentná green+transparent	<input checked="" type="checkbox"/> GG	zelená + zelená green+green	<input checked="" type="checkbox"/> OR	oranžová orange	<input checked="" type="checkbox"/> OT	oranžová + transparentná orange+transparent	<input checked="" type="checkbox"/> OO	oranžová + oranžová orange+orange
<input checked="" type="checkbox"/> SB	čierna matná soft touch black	<input checked="" type="checkbox"/> BT	čierna + transparentná soft touch black+transparent	<input checked="" type="checkbox"/> BB	čierna matná + čierna matná soft touch black+black																																									
<input checked="" type="checkbox"/> AT	antracit anthracite	<input checked="" type="checkbox"/> AT	antracit + transparentná anthracite+transparent	<input checked="" type="checkbox"/> AA	antracit + antracit anthracite+anthracite																																									
<input checked="" type="checkbox"/> ES	strieborná elox silver	<input checked="" type="checkbox"/> ST	strieborná + transparentná silver+transparent	<input checked="" type="checkbox"/> SS	strieborná + strieborná silver+silver																																									
<input checked="" type="checkbox"/> IW	slonová kosť ivory white	<input checked="" type="checkbox"/> IT	slonová kosť + transparentná ivory+transparent	<input checked="" type="checkbox"/> II	slonová kosť + slonová kosť ivory+ivory																																									
<input checked="" type="checkbox"/> RD	červená red	<input checked="" type="checkbox"/> RT	červená + transparentná red+transparent	<input checked="" type="checkbox"/> RR	červená + červená red+red																																									
<input checked="" type="checkbox"/> GR	zelená green	<input checked="" type="checkbox"/> GT	zelená + transparentná green+transparent	<input checked="" type="checkbox"/> GG	zelená + zelená green+green																																									
<input checked="" type="checkbox"/> OR	oranžová orange	<input checked="" type="checkbox"/> OT	oranžová + transparentná orange+transparent	<input checked="" type="checkbox"/> OO	oranžová + oranžová orange+orange																																									



ZÁSUVKA SCHUKO + KS 2P+E 16 A 25 0V ~ 2M

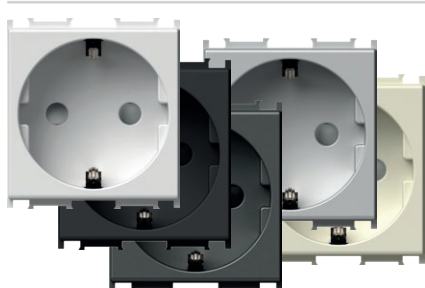

- VM10PW
- VM10MW
- VM10SB
- VM10AT
- VM10ES
- VM10IW

- 2P+E schuko
- 16 A 250 V ~, typ VM10
- v súlade s normou IEC 60884-1, CEE7
- skrutkové upevnenie vodičov 1,5 – 2,5 mm²
- zabudovaná ochrana pred dotykcom s kontaktmi pod napätím

SOCKET SCHUKO+KS 2P+E 16A 250V~ 2M

- 2P+E schuko
- 16 A 250V~, type VM10
- in accordance with IEC 60884-1, CEE7
- screw contacts 1.5-2.5 mm²
- shuttered live contacts



ZÁSUVKA SCHUKO + KS 2P+E 16 A 25 0V ~ 2M

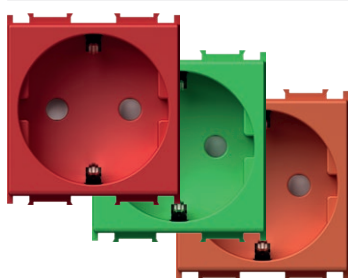

- VM10RD
- VM10GR
- VM10OR

- 2P+E schuko
- 16 A 250 V ~, typ VM10
- v súlade s normou IEC 60884-1, CEE7
- skrutkové upevnenie vodičov 1,5 – 2,5 mm²
- zabudovaná ochrana pred dotykcom s kontaktmi pod napätím

SOCKET SCHUKO+KS 2P+E 16A 250V~ 2M

- 2P+E schuko
- 16 A 250V~, type VM10
- in accordance with IEC 60884-1, CEE7
- screw contacts 1.5-2.5 mm²
- shuttered live contacts



ZÁSUVKA SCHUKO + KS + KRYT 2P+E 16 A 250 V ~ 2M



- VM11PT
- VM11MT
- VM11BT
- VM11AT
- VM11ST
- VM11IT
- VM11PP

- 2P + E schuko + kryt
- 16 A 250 V ~, typ VM11
- v súlade s normou IEC 60884-1, CEE7
- skrutkové upevnenie vodičov 1,5 – 2,5 mm²
- zabudovaná ochrana pred dotykcom s kontaktmi pod napätím

SOCKET SCHUKO+KS+COVER

- 2P+E 16A 250V~ 2M
- 2P+E schuko+cover
- 16 A 250V~, type VM11
- in accordance with IEC 60884-1, CEE7
- screw contacts 1.5-2.5 mm²
- shuttered live contacts



S O C K E T S V M

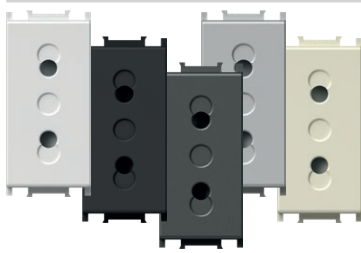

- VM20PW
- VM20MW
- VM20SB
- VM20AT
- VM20ES
- VM20IW

ZÁSUVKA EURO + KS 2P 10 A 250 V ~ 1M

- 2P Euro
- 10 A 250 V ~, typ VM20
- v súlade s normou IEC 60884-1, CEE7
- skrutkové upevnenie vodičov 1,5 – 2,5 mm²
- zabudovaná ochrana pred dotykom s kontaktmi pod napätím

SOCKET EURO+KS 2P 10A 250V~ 1M

- 2P Euro
- 10A 250V~, type VM20
- in accordance with IEC 60884-1, CEE7
- screw contacts 1.5-2.5 mm²
- shuttered live contacts

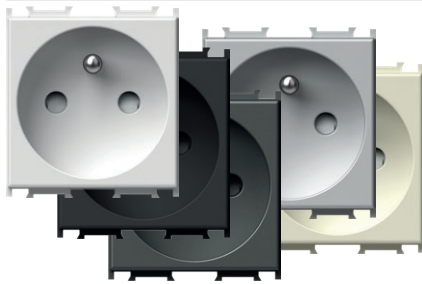

- VM40PW
- VM40MW
- VM40SB
- VM40AT
- VM40ES
- VM40IW

FRANCÚZSKA ZÁSUVKA +KS 2P+E 16 A 250 V ~ 2M

- 2P+E francúzska
- 16 A 250 V ~, typ VM40
- v súlade s normou IEC 60884-1, NF C 61-314, CEE7
- skrutkové upevnenie vodičov 1,5 – 2,5 mm²
- zabudovaná ochrana pred dotykom s kontaktmi pod napätím

SOCKET FRENCH+KS 2P+E 16A 250V~ 2M

- 2P+E French
- 16A 250V~, type VM40
- in accordance with IEC 60884-1, NF C 61-314, CEE7
- screw contacts 1.5-2.5 mm²
- shuttered live contacts

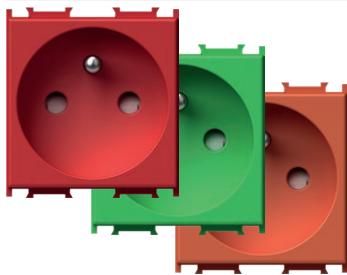

- VM40RD
- VM40GR
- VM40OR

FRANCÚZSKA ZÁSUVKA +KS 2P+E 16 A 250 V ~ 2M

- 2P+E francúzska
- 16 A 250 V ~, typ VM40
- v súlade s normou IEC 60884-1, NF C 61-314, CEE7
- skrutkové upevnenie vodičov 1,5 – 2,5 mm²
- zabudovaná ochrana pred dotykom s kontaktmi pod napätím

SOCKET FRENCH+KS 2P+E 16A 250V~ 2M

- 2P+E French
- 16A 250V~, type VM40
- in accordance with IEC 60884-1, NF C 61-314, CEE7
- screw contacts 1.5-2.5 mm²
- shuttered live contacts



- VM41PT
- VM41MT
- VM41BT
- VM41AT
- VM41PP
- VM41ST
- VM41IT

FRANCÚZSKA ZÁSUVKA + KS + KRYT 2P+E 16 A 250 V ~ 2M

- 2P+E francúzska + kryt
- 16 A 250 V ~, typ VM41
- v súlade s normou IEC 60884-1, NF C 61-314, CEE7
- skrutkové upevnenie vodičov 1,5 – 2,5 mm²
- zabudovaná ochrana pred dotykom s kontaktmi pod napätím

SOCKET FRENCH+KS+COVER 2P+E 16A 250V~ 2M

- 2P+E French+cover
- 16A 250V~, type VM41
- in accordance with IEC 60884-1, NF C 61-314, CEE7
- screw contacts 1.5-2.5 mm²
- shuttered live contacts

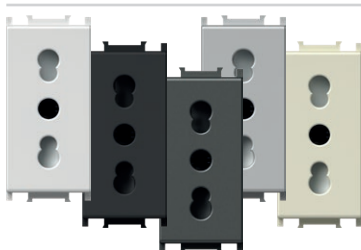

- VM30PW
- VM30MW
- VM30SB
- VM30AT
- VM30ES
- VM30IW

TALIANSKA ZÁSUVKA P17/11 + KS 2P + E 16 A 250 V ~ 1M

- 2P + E talianska P17/11
- 16 A 250 V ~, typ VM30
- v súlade s normou IEC 60884-1, CEI 23-50
- skrutkové upevnenie vodičov 1,5 – 2,5 mm²
- zabudovaná ochrana pred dotykom s kontaktmi pod napätím

SOCKET ITALIAN P17/11+KS 2P+E 16A 250V~ 1M

- 2P+E Italian P17/11
- 16A 250V~, type VM30
- in accordance with IEC 60884-1, CEI 23-50
- screw contacts 1.5-2.5 mm²
- shuttered live contacts

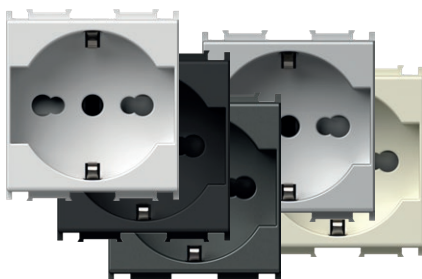

- VM31PW
- VM31MW
- VM31SB
- VM31AT
- VM31ES
- VM31IW

ZÁSUVKA SCHUKO/ITA P17/11+KS 2P+E 16 A 250 V ~ 2M

- 2P+E schuko/talianska P17/11
- 16 A 250 V ~, typ VM31
- v súlade s normou IEC 60884-1, CEI 23-50
- skrutkové upevnenie vodičov 1,5 – 2,5 mm²
- zabudovaná ochrana pred dotykom s kontaktmi pod napätím

SOCKET SCHUKO/ITA P17/11+KS 2P+E 16A 250V~ 2M

- 2P+E schuko/Italian P17/11
- 16A 250V~, type VM31
- in accordance with IEC 60884-1, CEI 23-50
- screw contacts 1.5-2.5 mm²
- shuttered live contacts

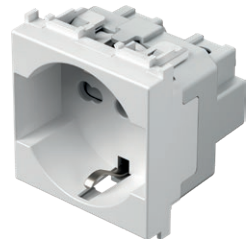

ZÁSUVKA SCHUKO/ITA P30+KS 2P+E 16 A 250 V ~ 2M

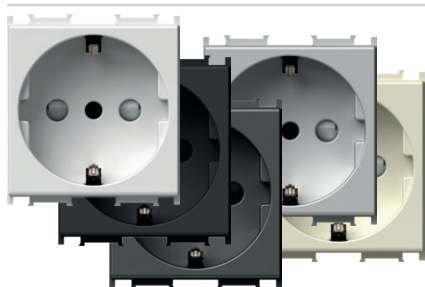

- VM32PW
- VM32MW
- VM32SB
- VM32AT
- VM32ES
- VM32IW

- 2P+E schuko/italianska P30
- 16 A 250 V ~, typ VM32
- v súlade s normou IEC 60884-1, CEI 23-50
- skrutkové upevnenie vodičov 1,5 – 2,5 mm²
- zabudovaná ochrana pred dotykom s kontaktmi pod napätím



SOCKET SCHUKO/ITA P30+KS 2P+E 16A 250V~ 2M

- 2P+E schuko/Italian P30
- 16A 250V~, type VM32
- in accordance with IEC 60884-1, CEI 23-50
- screw contacts 1.5-2.5 mm²
- shuttered live contacts

TALIANSKA ZÁSUVKA P11+KS 2P+E 10 A 250 V ~ 1M

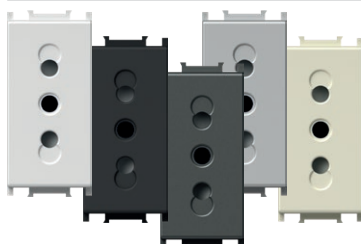

- VM33PW
- VM33MW
- VM33SB
- VM33AT
- VM33ES
- VM33IW

- 2P + E talianska P11
- 10 A 250 V ~, typ VM33
- v súlade s normou IEC 60884-1, CEI 23-50
- skrutkové upevnenie vodičov 1,5 – 2,5 mm²
- zabudovaná ochrana pred dotykom s kontaktmi pod napätím



SOCKET ITALIAN P11+KS 2P+E 10A 250V~ 1M

- 2P+E Italian P11
- 10A 250V~, type VM33
- in accordance with IEC 60884-1, CEI 23-50
- screw contacts 1.5-2.5 mm²
- shuttered live contacts

EURÓPSKA/AMERICKÁ ZÁSUVKA + KS 2P 16 A 250 V ~ 1M

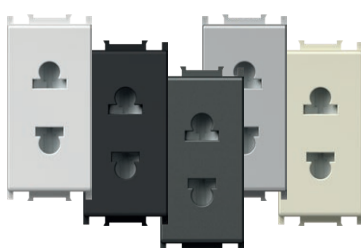

- VM21PW
- VM21MW
- VM21SB
- VM21AT
- VM21ES
- VM21IW

- 2P európska/americká
- 16 A 250 V ~, typ VM21
- skrutkové upevnenie vodičov 1,5 – 2,5 mm²
- zabudovaná ochrana pred dotykom s kontaktmi pod napätím
- len pre krajiny, ktoré nie sú členmi EÚ



SOCKET EURO/AMERICAN+KS 2P 16A 250V~ 1M

- 2P Euro/American
- 16A 250V~, type VM21
- screw contacts 1.5-2.5 mm²
- shuttered live contacts
- only for countries not members of EU

BRITSKÁ ZÁSUVKA BS 1363-2+KS 2P+E 13 A 250 V ~ 2M

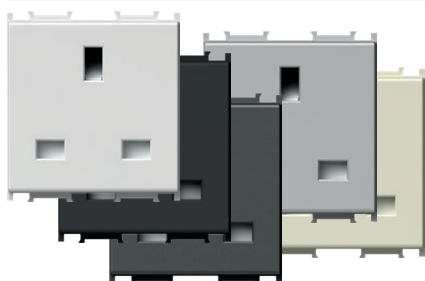

- VM52PW
- VM52MW
- VM52SB
- VM52AT
- VM52ES
- VM52IW

- 2P+E britská BS 1363-2
- 13 A 250 V ~, typ VM52
- v súlade s normou BS 1363-2
- skrutkové upevnenie vodičov 1,5 až 4 mm²
- zabudovaná ochrana pred dotykom s kontaktmi pod napätím

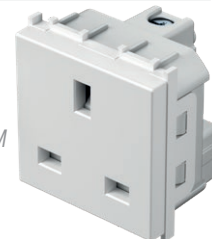

SOCKET BRITISH BS 1363-2+KS 2P+E 13A 250V~ 2M

- 2P+E British BS 1363-2
- 13A 250V~, type VM52
- in accordance with BS 1363-2
- screw contacts 1.5-4 mm²
- shuttered live contacts

ZÁSUVKA VIACÚČELOVÁ+KS 2P+E 13A 250V~ 2M

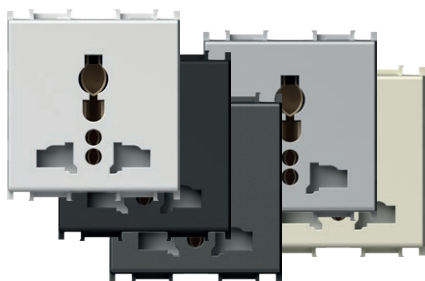

- VM55PW
- VM55MW
- VM55SB
- VM55AT
- VM55ES
- VM55IW

- bezskrutkové upevnenie vodičov 1,5-2,5 mm²
- zabudovaná ochrana proti dotyku kontaktov

SOCKET MULTI-STANDARD+KS 2P+E 13A 250V~ 2M

- plug-in contacts 1.5–2.5 mm²
- shuttered live contacts



PREPÄŤOVÁ OCHRANA MPE MINI 275 V/50 Hz



VM80

- paralelné spojenie s prvou zásuvkou v rade
- trieda ochrany III
- U_c = 275 Vac, U_{oc}/I_{sc} = 6 kV/3 kA, U_p < 800 V
- v súlade s normou IEC 61643-1
- vodiče 1,5mm², IP20
- zvukový signál pri poruche



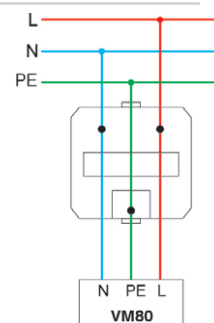

SURGE PROTECTOR MPE MINI 275V/50Hz

- parallel connection with the first socket in the row
- protection class III
- U_c=275V~, U_{oc}/I_{sc}=6kV/3kA, U_p<800V
- in accordance with IEC 61643-1
- wires 1.5mm², IP20
- sound signal at breakdown





S O C K E T S V M

 ZHODA ZÁSUVIEK A VIDLÍČ
 SOCKETS AND PLUGS MATCHING

ZÁSUVKA / SOCKET	VM10 VM11	VM20	VM30	VM33	VM31	VM32	VM40 VM41	VM21	VM55
TVAR VIDLICE / PLUG STYLE									
Nemecký / German 	•				•	•			•
Francúzsky / French 	•				•	•	•		•
Taliansky / Italian S11 			•	•	•	•			•
Taliansky / Italian S17 			•		•				•
Európsky 	•	•	•		•	•	•	•	•

 ZHODA ZÁSUVIEK A VIDLÍČ
 SOCKETS AND PLUGS MATCHING

ZÁSUVKA / SOCKET	VM21	VM52	VM55
TVAR VIDLICE / PLUG STYLE			
Americký / American 	•		•
Britský / British BS 1363-2 		•	•

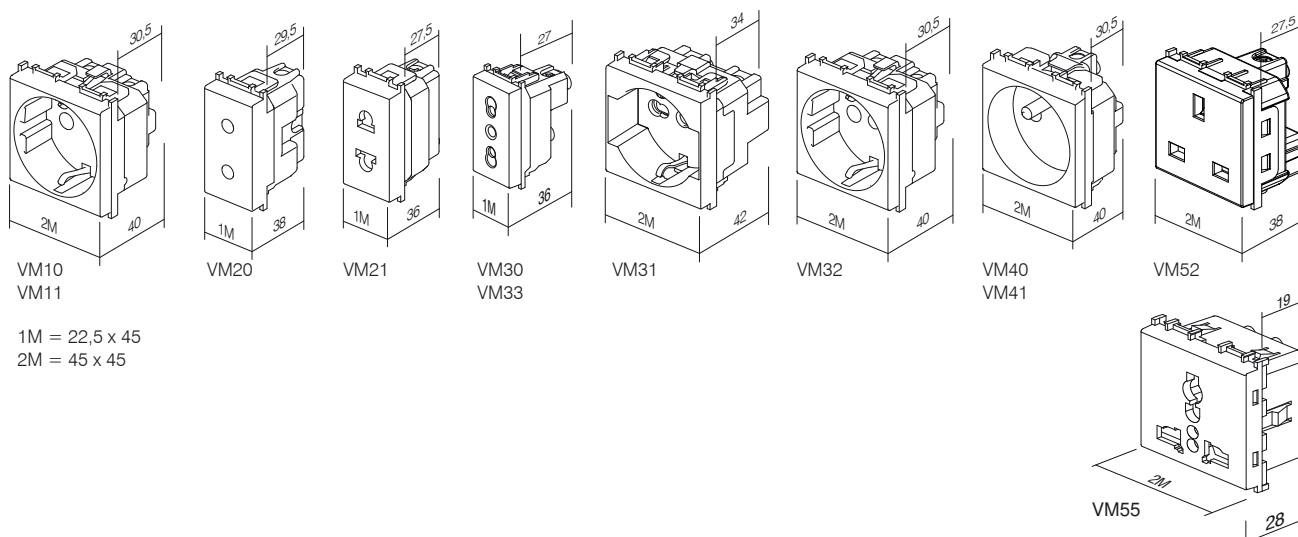



typ type	popis description	technické dáta technical data	veľkosť size	farba colour
KM10	ZÁSUVKA TV ZÁKLADNÁ SOCKET TV BASIC	0dB	1M	<input type="checkbox"/> PW polárna biela polar white
KM11	ZÁSUVKA TV KONCOVÁ SOCKET TV END-LINE	1dB	1M	<input type="checkbox"/> MW biela matná matte white
KM12	ZÁSUVKA TV PRIEBEŽNÁ SOCKET TV TROUGH-PASS	10dB	1M	<input checked="" type="checkbox"/> SB čierna matná zamatová soft touch black
⋮	⋮	⋮	⋮	<input type="checkbox"/> AT antracit anthracite
⋮	⋮	⋮	⋮	<input type="checkbox"/> ES strieborná matná elox silver
⋮	⋮	⋮	⋮	<input type="checkbox"/> IW slonová kosť ivory white

ZÁSUVKA TV ZÁKLADNÁ 0 dB 1M



- KM10PW
- KM10MW
- KM10SB
- KM10AT
- KM10ES
- KM10IW

- TV základná
 - útlm 0 dB
 - zadný konektor – F štandard
- SOCKET TV BASIC 0dB 1M*
- TV basic
 - reduction 0dB
 - back connector – F standard



ZÁSUVKA TV ZÁKLADNÁ 0 dB 2M

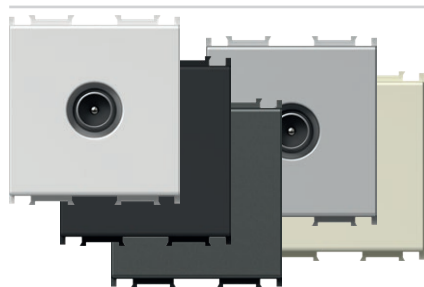

- KM20PW
- KM20MW
- KM20SB
- KM20AT
- KM20ES
- KM20IW

- TV základná
 - útlm 0 dB
 - zadný konektor – F štandard
- SOCKET TV BASIC 0dB 2M*
- TV basic
 - reduction 0dB
 - back connector – F standard



ZÁSUVKA TV KONCOVÁ 1 dB 1M



- KM11PW
- KM11MW
- KM11SB
- KM11AT
- KM11ES
- KM11IW

- TV koncová
 - frekvenčné pásmo 5 ÷ 2 400 MHz
 - útlm < 1 dB
 - v súlade s normou EN 50083-1
 - skrutkové upevnenie vodičov
- SOCKET TV END-LINE 1dB 1M*
- TV end-line
 - frequency range 5÷2400 MHz
 - reduction < 1 dB
 - in accordance with EN 50083-1
 - screw contacts

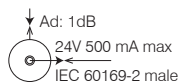

ZÁSUVKA TV PRIEBEŽNÁ 10 dB 1M



- KM12PW
- KM12MW
- KM12SB
- KM12AT
- KM12ES
- KM12IW

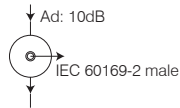

- TV priebežná
- frekvenčné pásmo 5 ÷ 2 400 MHz
- útlm < 10 dB
- v súlade s normou EN 50083-1
- skrutkové upevnenie vodičov

SOCKET TV TROUGH-PASS 10dB 1M

- TV troughpass
- frequency range 5÷2400 MHz
- reduction < 10 dB
- in accordance with EN 50083-1
- screw contacts



ZÁSUVKA SAT ZÁKLADNÁ 0 dB 1M



- KM15PW
- KM15MW
- KM15SB
- KM15AT
- KM15ES
- KM15IW

- SAT základná
- útlm 0 dB
- zadný konektor – F štandard

SOCKET SAT BASIC 0dB 1M

- SAT basic
- reduction 0dB
- back connector – F standard



ZÁSUVKA SAT ZÁKLADNÁ 0 dB 2M

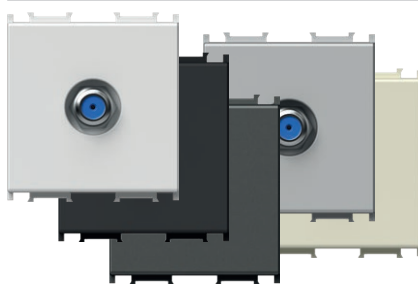

- KM24PW
- KM24MW
- KM24SB
- KM24AT
- KM24ES
- KM24IW

- SAT základná
- útlm 0 dB
- zadný konektor – F štandard

SOCKET SAT BASIC 0dB 2M

- SAT basic
- reduction 0dB
- back connector – F standard



ZÁSUVKA SAT KONCOVÁ 1dB 1M



- KM16PW
- KM16MW
- KM16SB
- KM16AT
- KM16ES
- KM16IW

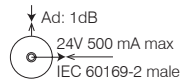

- SAT koncová
- frekvenčné pásmo 5 ÷ 2 400 MHz
- útlm < 1 dB
- v súlade s normou EN 50083-1
- skrutkové upevnenie vodičov

SOCKET SAT END-LINE 1dB 1M

- SAT end-line
- frequency range 5÷2400 MHz
- reduction < 1dB
- in accordance with EN 50083-1
- screw contacts



ZÁSUVKA R ZÁKLADNÁ 0 dB 1M



- KM19PW
- KM19MW
- KM19SB
- KM19AT
- KM19ES
- KM19IW

- R základná
- útlm 0 dB
- zadný konektor – F štandard

SOCKET R BASIC 0dB 1M

- R basic
- reduction 0dB
- back connector – F standard



ZÁSUVKA R ZÁKLADNÁ 0 dB 2M

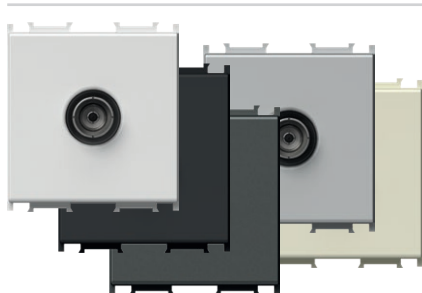

- KM29PW
- KM29MW
- KM29SB
- KM29AT
- KM29ES
- KM29IW

- R základná
- útlm 0 dB
- zadný konektor – F štandard

SOCKET R BASIC 0dB 2M

- R basic
- reduction 0dB
- back connector – F standard



ZÁSUVKA SAT-TV KONCOVÁ 1 dB 1M



- KM17PW
- KM17MW
- KM17SB
- KM17AT
- KM17ES
- KM17IW

- SAT-TV koncová
- frekvenčné pásmo 5 ÷ 2 400 MHz
- útlm < 1 dB
- v súlade s normou EN 50083-1
- skrutkové upevnenie vodičov

SOCKET SAT-TV END-LINE 1dB 1M

- SAT-TV end-line
- frequency range 5÷2400 MHz
- reduction < 1dB
- in accordance with EN 50083-1
- screw contacts

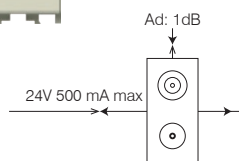

ZÁKLADNÉ SCHÉMY ZAPOJENIA

BASIC CONNECTION SAMPLES

Samostatné zapojenie
stand alone connection

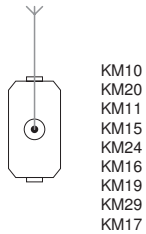

Zapojenie do hviezdy
star connection

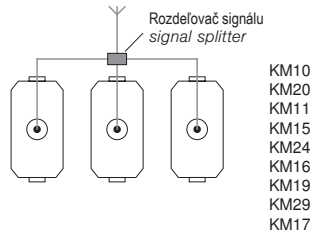

Sériové zapojenie
throughpass connection

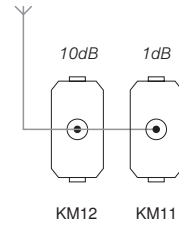

ZÁSUVKA AUDIO 2 x RCA 1M



- KM22PW
- KM22MW
- KM22SB
- KM22AT
- KM22ES
- KM22IW

- audio 2 x RCA
- upevnenie vodičov vzadu spájkovaním

SOCKET AUDIO 2xRCA 1M

- audio 2x RCA
- soldering connection of cable at the back side



ZÁSUVKA AUDIO REPRODUKTOROVÁ 1M



- KM23PW
- KM23MW
- KM23SB
- KM23AT
- KM23ES
- KM23IW

- audio 2 x Ø 4 mm
- na pripojenie reproduktorového vodiča, banánovej zástrčky Ø 4 mm alebo vidlicovej káblovej pätky
- upevnenie vodičov vzadu spájkovaním

SOCKET AUDIO LOUDSPEAKERS 1M

- audio 2x Ø4mm
- to accommodate speaker wire, banana plug Ø4mm or spades
- soldering connection of cable at the back side



ZÁSUVKA AUDIO REPRODUKTOROVÁ 2M



- KM26PW
- KM26MW
- KM26SB
- KM26AT
- KM26ES
- KM26IW

- audio 2 x Ø 4 mm
- na pripojenie reproduktorového vodiča, banánovej zástrčky Ø 4 mm alebo vidlicovej káblovej pätky
- upevnenie vodičov vzadu spájkovaním

SOCKET AUDIO LOUDSPEAKERS 2M

- audio 2x Ø4mm
- to accommodate speaker wire, banana plug Ø4mm or spades
- soldering connection of cable at the back side



1M = 22,5 x 45
2M = 45 x 45

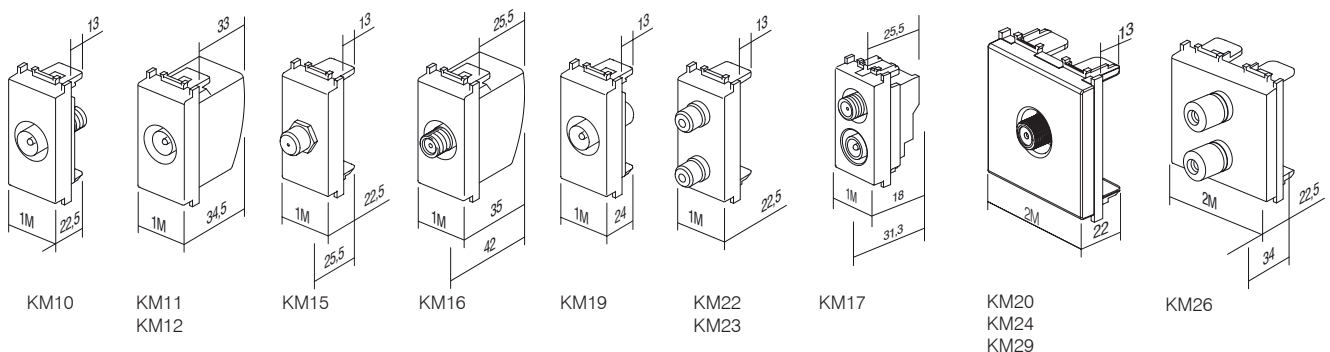

ZÁSUVKA TEL LT RJ11 6/4 1M



- KM30PW
- KM30MW
- KM30SB
- KM30AT
- KM30ES
- KM30IW

- skrutka TEL LT
- RJ11 6/4
- v súlade s normou IEC 60603-7
- skrutkové upevnenie vodičov

SOCKET TEL LT RJ11 6/4 1M

- TEL LT screw
- RJ11 6/4
- in accordance with IEC 60603-7
- screw contacts



ZÁSUVKA TEL BT SEC 6/6 1M

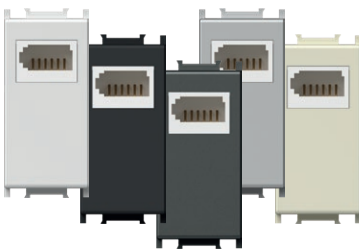

- KM31PW
- KM31MW
- KM31SB
- KM31AT
- KM31ES
- KM31IW

- TEL BT štandardná britská
- SEC sekundárny 6/6
- v súlade s normou BS 6312
- skrutkové upevnenie vodičov

SOCKET TEL BT SEC 6/6 1M

- TEL BT British standard
- SEC secondary 6/6
- in accordance with BS 6312
- screw contacts



ZÁSUVKA TEL KS RJ11 6/4 1M

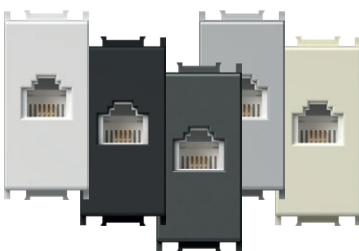

- KM36PW
- KM36MW
- KM36SB
- KM36AT
- KM36ES
- KM36IW

- KS keystone štandard upevnenia
- RJ11 6/4
- v súlade s normou IEC 60603-7

SOCKET TEL KS RJ11 6/4 1M

- KS keystone fixing standard
- RJ11 6/4
- in accordance with IEC 60603-7

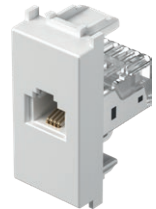

ZÁSUVKA KAT. 5e KS RJ45 8/8 1M

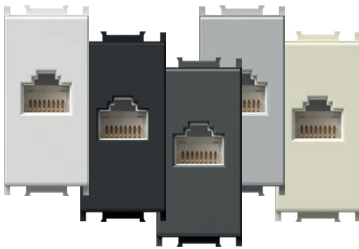

- KM37PW
- KM37MW
- KM37SB
- KM37AT
- KM37ES
- KM37IW

- KS keystone štandard upevnenia
- KAT. 5e, RJ45 8/8
- v súlade s normou IEC 60603-7

SOCKET CAT5e KS RJ45 8/8 1M

- KS keystone fixing standard
- CAT5e, RJ45 8/8
- in accordance with IEC 60603-7

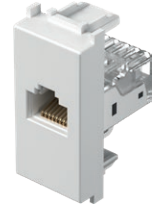

ADAPTÉR KS 1M

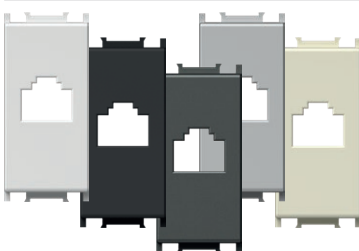

- KM35PW
- KM35MW
- KM35SB
- KM35AT
- KM35ES
- KM35IW

- KS keystone štandard upevnenia
- AMP, Avaya, Brandrex, FMT, Mfico, Tyco, ...
- komunikačný modul nie je súčasťou

ADAPTER KS 1M

- KS keystone fixing standard
- AMP, Avaya, Brandrex, FMT, Mfico, Tyco, ...
- communication module not included



ADAPTÉR KS S OCHRANOU PROTI PRACHU 1M



- KM38PW
- KM38MW
- KM38SB
- KM38AT
- KM38ES
- KM38IW

- KS keystone štandard upevnenia s ochranou proti prachu
- AMP, Avaya, Brandrex, FMT, Mfico, Tyco, ...
- komunikačný modul nie je súčasťou

ADAPTER KS WITH DUST PROTECTION 1M

- KS keystone fixing standard with dust protection
- AMP, Avaya, Brandrex, FMT, Mfico, Tyco, ...
- communication module not included



ZÁSUVKA KS KAT. 6 SCH RJ45 8/8 1M

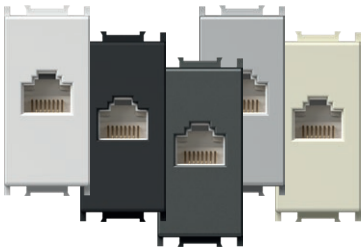

- KM39PW
- KM39MW
- KM39SB
- KM39AT
- KM39ES
- KM39IW

- KS keystone štandard upevnenia
- KAT. 6 UTP bez použitia nástrojov, RJ45 8/8
- v súlade s normou ISO/IEC 11801

SOCKET CAT6 SCH KS RJ45 8/8 1M

- KS keystone fixing standard
- CAT6 UTP toolless, RJ45 8/8
- in accordance with ISO/IEC 11801

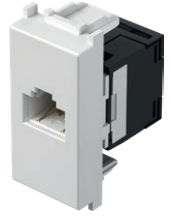

ADAPTÉR KS UNIVERZÁLNY 1M

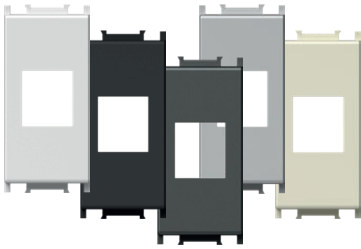

- KM50PW
- KM50MW
- KM50SB
- KM50AT
- KM50ES
- KM50IW

- KS keystone štandard upevnenia
- vhodné pre HDMI, USB
- komunikačný modul nie je súčasťou

ADAPTER KS UNIVERSAL 1M

- KS keystone fixing standard
- suitable for HDMI, USB
- communication module not included



ADAPTÉR PD 1M

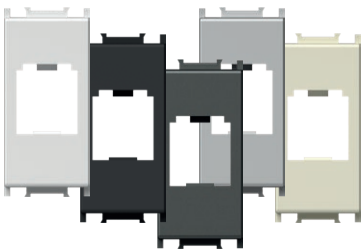

- KM40PW
- KM40MW
- KM40SB
- KM40AT
- KM40ES
- KM40IW

- štandard upevnenia PD Panduit Mini-COM
- komunikačný modul nie je súčasťou

ADAPTER PD 1M

- PD Panduit Mini-COM fixing standard
- communication module not included



ADAPTÉR PD S OCHRANOU PROTI PRACHU 1M



- KM43PW
- KM43MW
- KM43SB
- KM43AT
- KM43ES
- KM43IW

- PD štandard upevnenia Panduit Mini-COM
s ochranou proti prachu
- komunikačný modul nie je súčasťou

ADAPTER PD WITH DUST PROTECTION 1M

- PD Panduit Mini-COM fixing standard with
dust protection
- communication module not included



ADAPTÉR R&M 1M

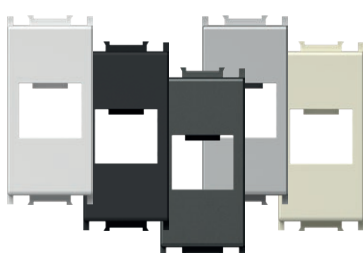

- KM46PW
- KM46MW
- KM46SB
- KM46AT
- KM46ES
- KM46IW

- štandard upevnenia R&M
- komunikačný modul nie je súčasťou

ADAPTER R&M 1M

- R&M fixing standard
- communication module not included



ADAPTÉR CAT6A 1M ZNAČKY R&M

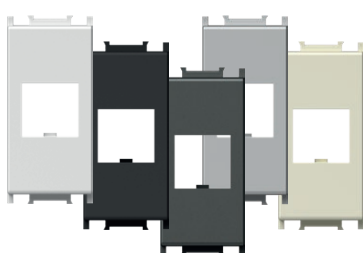

- KM52PW
- KM52MW
- KM52SB
- KM52AT
- KM52ES
- KM52IW

- R&M upevnenie pre CAT6A
- komunikačný modul nie je súčasťou

ADAPTER R&M CAT6A 1M

- R&M fixing for CAT6A
- communication module not included



ADAPTÉR R&M S OCHRANOU PROTI PRACHU 1M



- KM47PW
- KM47MW
- KM47SB
- KM47AT
- KM47ES
- KM47IW

- R&M štandard upevnenia s ochranou proti prachu
- komunikačný modul nie je súčasťou

ADAPTER R&M WITH DUST PROTECTION 1M

- R&M fixing standard with dust protection
- communication module not included



ADAPTÉR R&M CAT6A S OCHRANOU PROTI PRACHU 1M



- KM53PW
- KM53MW
- KM53SB
- KM53AT
- KM53ES
- KM53IW

- R&M upevnenie pre CAT6A s ochranou proti prachu
- komunikačný modul nie je súčasťou

ADAPTER R&M CAT6A WITH DUST PROTECTION 1M

- R&M fixing for CAT6A with dust protection
- communication module not included



ADAPTÉR LK 1M

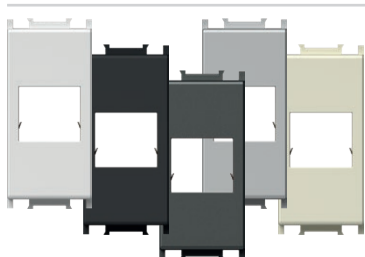

- KM45PW
- KM45MW
- KM45SB
- KM45AT
- KM45ES
- KM45IW

- štandard upevnenia LK LeoniKerpen eLine/BKS NewLine
- komunikačný modul nie je súčasťou

ADAPTER LK 1M

- LK LeoniKerpen eLine / BKS NewLine fixing standard
- communication module not included



ADAPTÉR NEXANS/SCHRACK 2M

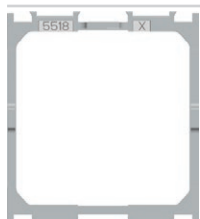

KA26

- adaptér upevnenia pre modul Nexans LANmark
a Schrack 45 x 45 mm
- vhodné pre Nexans typu N423.540N
- vhodné pre Schrack typu HSEMD02W2F
- komunikačný modul nie je súčasťou

ADAPTER NEXANS/SCHRACK 2M

- fixing adapter for Nexans LANmark and
Schrack module 45x45mm
- suitable for Nexans type N423.540N
- suitable for Schrack type HSEMD02W2F
- communication module not included

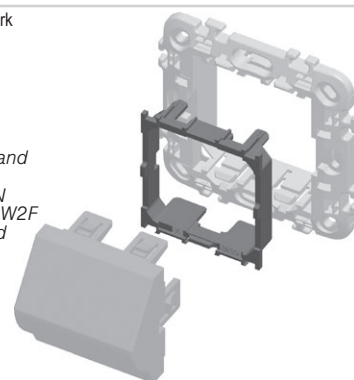

ADAPTÉR AT&T SYSTIMAX S OCHRANOU PROTI PRACHU 1M

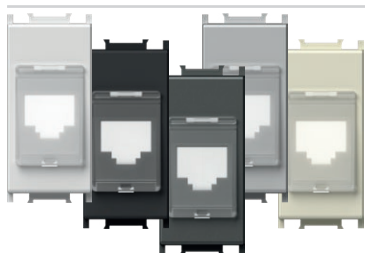

- KM48PW
- KM48MW
- KM48SB
- KM48AT
- KM48ES
- KM48IW

- štandard upevnenia AT&T Systemax s ochranou proti prachu
- komunikačný modul nie je súčasťou

ADAPTER AT&T SYSTIMAX WITH DUST PROTECTION 1M

- AT&T Systemax fixing standard with dust protection
- communication module not included



USB ZÁSUVKA TYPU 1M



- KM51PW
- KM51MW
- KM51SB
- KM51AT
- KM51ES
- KM51IW

- USB 2.0 zásuvka typu A
- skrutkové upevnenie vodičov, raster 5 mm, 1,5 mm², 1 x 2P + 1 x 3P
- zapojenie:
PIN 1 – VCC (+ 5 V, červený vodič)
PIN 2 – dátový - (biely vodič)
PIN 3 – dátový + (zelený vodič)
PIN 4 – GND – uzemňovací (čierny vodič)
S – tienenie
- v súlade so Smernicou 2011/95/EC (RoHS2)

SOCKET USB TYPE A 1M

- USB 2.0 socket type A
- screw contacts, raster 5 mm, 1,5 mm², 1x2P + 1x3P
- wiring:
PIN 1 – VCC (+5V, red wire)
PIN 2 – Data - (white wire)
PIN 3 – Data + (green wire)
PIN 4 – GND - ground (black wire)
S – shield
- in accordance with directive 2011/95/EU (RoHS2)



1M = 22,5 x 45
2M = 45 x 45

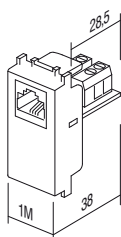

KM30

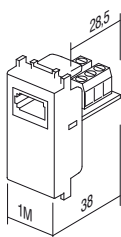

KM31

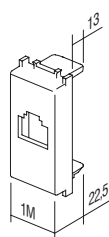
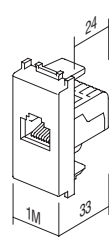
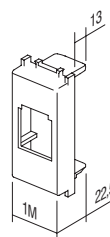
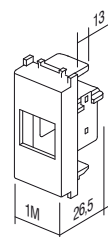
KM35
KM38
KM48KM36
KM37
KM39KM40
KM43

KM45

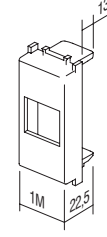
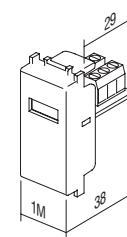
KM46
KM47
KM50
KM52
KM53

KM51



KA10

typ type	popis description	technické dáta technical data
KA10	KONEKTOR KS KAT. 3 CONNECTOR KS CAT3	RJ11 6/4
KA11	KONEKTOR KS KAT. 5e CONNECTOR KS CAT5e	RJ45 8/8
KA12	KONEKTOR KS KAT. 5eS CONNECTOR KS CAT5eS	RJ45 8/8
⋮	⋮	⋮

KONEKTOR KS KAT. 3 RJ11 6/4



KA10

- KS keystone štandard upevnenia
- KAT. 3, RJ11 6/4
- v súlade s normou IEC 60603-7

CONNECTOR KS CAT3 RJ11 6/4

- KS keystone fixing standard
- CAT3, RJ11 6/4
- in accordance with IEC 60603-7

KONEKTOR KS KAT. 5e RJ45 8/8



KA11

- KS keystone štandard upevnenia
- KAT. 5e, RJ45 8/8
- v súlade s normou IEC 60603-7

CONNECTOR KS CAT5e RJ45 8/8

- KS keystone fixing standard
- CAT5e, RJ45 8/8
- in accordance with IEC 60603-7

KONEKTOR KS KAT. 5eS RJ45 8/8



KA12

- KS keystone štandard upevnenia
- KAT. 5eS, RJ45 8/8
- v súlade s normou IEC 60603-7

CONNECTOR KS CAT5eS RJ45 8/8

- KS keystone fixing standard
- CAT5eS, RJ45 8/8
- in accordance with IEC 60603-7



KA15

KONEKTOR KS KAT. 6 SCH RJ45 8/8

- KS keystone štandard upevnenia
- KAT. 6 UTP bez použitia nástrojov, RJ45 8/8
- v súlade s normou ISO/IEC 11801

CONNECTOR KS CAT6 SCH RJ45 8/8

- KS keystone fixing standard
- CAT6 UTP toolless, RJ45 8/8
- in accordance with ISO/IEC 11801



KA16

KONEKTOR KS KAT. 6S SCH RJ45 8/8

- KS keystone štandard upevnenia
- KAT. 6S STP bez použitia nástrojov, RJ45 8/8
- v súlade s normou ISO/IEC 11801

CONNECTOR KS CAT6S SCH RJ45 8/8

- KS keystone fixing standard
- CAT6S STP toolless, RJ45 8/8
- in accordance with ISO/IEC 11801



KA17

KONEKTOR KS KAT. 6a SCH RJ45 8/8

- KS keystone štandard upevnenia
- KAT. 6a STP bez použitia nástrojov, RJ45 8/8
- v súlade s normou ISO/IEC 11801

CONNECTOR KS CAT6a SCH RJ45 8/8

- KS keystone fixing standard
- CAT6a STP toolless, RJ45 8/8
- in accordance with ISO/IEC 11801



KA18

KONEKTOR SLIM KS KAT. 6S SCH RJ45 8/8

- KS keystone štandard upevnenia
- úzke prevedenie
- KAT. 6S STP bez použitia nástrojov, RJ45 8/8
- v súlade s normou ISO/IEC 11801
- vhodný aj pre dvojité adaptéry KE46

CONNECTOR SLIM KS CAT6S SCH RJ45 8/8

- KS keystone fixing standard
- slim style
- CAT6S STP toolless, RJ45 8/8
- in accordance with ISO/IEC 11801
- suitable also for KE46 double adapter

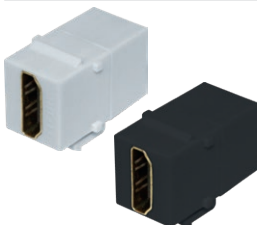

□ KA27PW
■ KA27BK

KONEKTOR KS HDMI

- KS keystone štandard upevnenia
- len v kombinácii s adaptérom KM50
- HDMI/HDMI

CONNECTOR KS HDMI

- KS keystone fixing standard
- only in combination with adapter KM50
- HDMI/HDMI



KA28

KÁBEL KS HDMI

- KS keystone štandard upevnenia
- len v kombinácii s adaptérom KM50
- HDMI/HDMI

CABLE KS HDMI

- KS keystone fixing standard
- only in combination with adapter KM50
- HDMI/HDMI



EM33



PW



typ type	popis description	technické dáta technical data	veľkosť size	farba colour
EM12	STMIEVAČ ROTAČNÝ/STRIEDAVÝ DIMMER ROTATIVE 2WAY	RL 300W	1M	<input type="checkbox"/> PW polárna biela polar white <input type="checkbox"/> MW biela matná matte white <input type="checkbox"/> SB čierna matná zamatová soft touch black <input type="checkbox"/> AT antracit anthracite <input type="checkbox"/> ES strieborná matná elox silver <input type="checkbox"/> IW slonová kosť ivory white
EM23	ZABUDOVATELNÝ STMIEVAČ DIMMER INBOX	R (250 W), (RC,RL 200VA)	/	<input type="checkbox"/> BL modrá blue <input type="checkbox"/> RD červená red <input type="checkbox"/> GR zelená green <input type="checkbox"/> OR oranžová orange <input type="checkbox"/> RG červeno-zelená red/green
.
.



- EM12PW
- EM12MW
- EM12SB
- EM12AT
- EM12ES
- EM12IW

STMIEVAČ ROTAČNÝ/STRIEDAVÝ RL 300 W 1M

- ovládanie rotáciou so striedavým prepínačom
- zaťaženie RL, 40 W – 300W
- napájacie napätie 230 V – 50 Hz
- umožňuje kombináciu s ďalším striedavým prepínačom
- montáž viacerých zariadení spolu do jednej krabice je prípustná len za predpokladu, že ich celkový maximálny výkon neprekračuje maximálny výkon jedného stmievača
- v jednom obvode je povolené použitie len jedného stmievača
- istič nie je zabudovaný – použite externý istič
- v súlade s normou EN 60669-1
- skrutkové upevnenie vodičov – 1,5 – 2,5 mm²
- integrovaná LED indikácia úrovne stmievania



DIMMER ROTATIVE/2WAY RL 300W 1M

- rotation control with 2-way switch
- load RL, 40W - 300W
- supply voltage 230V~ 50Hz
- 2-way switch combination is possible
- installing several devices together in one box is only permitted if their total maximum load does not exceed the maximum power of a single dimmer
- one circuit allows the use of only one dimmer
- no built-in fuse – external fuse must be used
- in accordance with EN 60669-1
- screw contacts - 1.5-2.5mm²
- integrated LED indication of dimming level

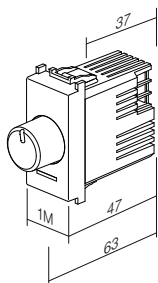

STMIEVAČ ROTAČNÝ/STRIEDAVÝ LED 60 W 1M



- EM13PW
- EM13MW
- EM13SB
- EM13AT
- EM13ES
- EM13IW

- ovládanie rotáciou so striedavým prepínačom
- zaťaženie:
LED, 0 – 60 W (max. 6 stmievateľné LED žiarivky)
GLS, 0 – 60 W
- napájacie napätie 230 V ~ 50 Hz
- umožňuje kombináciu s ďalším striedavým prepínačom
- montáž viacerých zariadení spolu do jednej krabice je prípustná len za predpokladu, že ich celkový maximálny výkon neprekračuje maximálny výkon jedného stmievача
- v jednom obvode je povolené použitie len jedného stmievача
- istič nie je zabudovaný – použite externý istič
- v súlade s normou IEC60669-2-1
- skrutkové upevnenie vodičov – 1,5 – 2,5 mm²

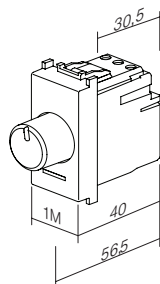

DIMMER ROTATIVE/2WAY LED 60W 1M

- rotation control with 2-way switch
- loads: LED, 0 – 60W (max. 6 dimmable LED lamps)
GLS, 0 – 60W
- supply voltage 230V~ 50Hz
- 2-way switch combination is possible
- installing several devices together in one box is only permitted if their total maximum load does not exceed the maximum power of a single dimmer
- one circuit allows the use of only one dimmer
- no built-in fuse – external fuse must be used
- in accordance with IEC60669-2-1
- screw contacts - 1.5-2.5mm²

STMIEVAČ ROTAČNÝ/STRIEDAVÝ LED 180W 1M



- EM14PW
- EM14MW
- EM14SB
- EM14AT
- EM14ES
- EM14IW

- ovládanie rotáciou so striedavým prepínačom
- zaťaženie:
LED, 0 – 180W (max. 20 stmievateľné LED žiarivky)
GLS, 0 – 180W
- napájacie napätie 230 V ~ 50 Hz
- umožňuje kombináciu s ďalším striedavým prepínačom
- montáž viacerých zariadení spolu do jednej krabice je prípustná len za predpokladu, že ich celkový maximálny výkon neprekračuje maximálny výkon jedného stmievача
- v jednom obvode je povolené použitie len jedného stmievача
- istič nie je zabudovaný – použite externý istič
- v súlade s normou IEC60669-2-1
- skrutkové upevnenie vodičov – 1,5 – 2,5 mm²

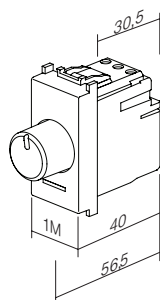

DIMMER ROTATIVE/2WAY LED 180W 1M

- rotation control with 2-way switch
- loads:
LED, 0 – 180W (max. 20 dimmable LED lamps)
GLS, 0 – 180W
- supply voltage 230V~ 50Hz
- 2-way switch combination is possible
- installing several devices together in one box is only permitted if their total maximum load does not exceed the maximum power of a single dimmer
- one circuit allows the use of only one dimmer
- no built-in fuse – external fuse must be used
- in accordance with IEC60669-2-1
- screw contacts - 1.5-2.5mm²

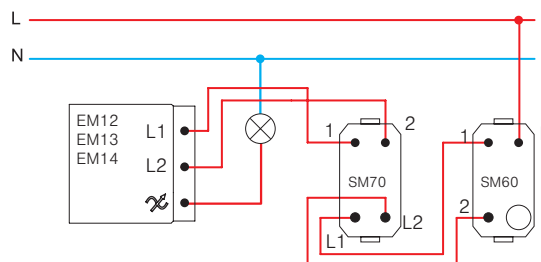
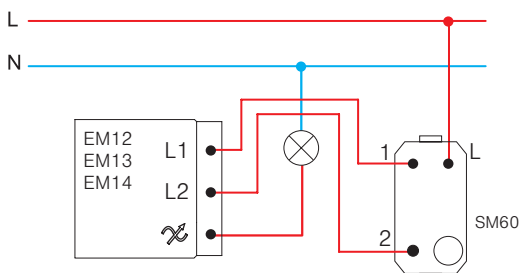
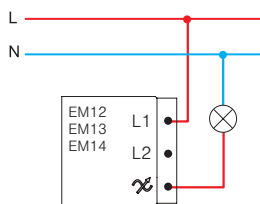

STMIEVAČ ROTAČNÝ R 250 W 1M



- EM15PW
- EM15MW
- EM15SB
- EM15AT
- EM15ES
- EM15IW



- ovládanie rotácie bez prepínača
- zaťaženie R, 40 W – 250 W
- napájacie napätie 230 V ~ 50 Hz
- kombinácia so striedavým prepínačom nie je možná
- kombinácia s viacerými stmievačmi nie je povolená
- v súlade s normou EN 60669-1
- skrutkové upevnenie vodičov 1,5 – 2,5 mm²
- indikácia LED diódou

DIMMER ROTATIVE R 250W 1M

- rotation control without switch
- load R, 40W - 250W
- supply voltage 230V~ 50Hz
- 2-way switch combination is not possible
- more dimmers combination is not allowed
- in accordance with EN 60669-1
- screw contacts 1.5-2.5mm²
- LED indication

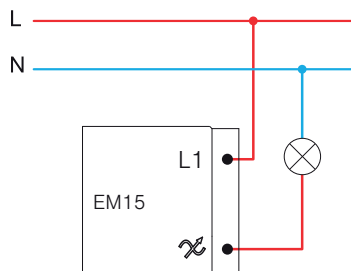
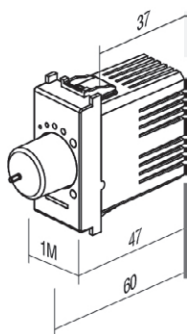

ZABUDOVATEĽNÝ STMIEVAČ R (250 W), (EC, RL 200 VA)



EM23



- v schránke, ovládaný vonkajším tlačidlom
- zaťaženie RLC 15-250 W alebo 15-200 VA
- napájacie napätie 230 V ~ 50 Hz
- k dispozícii je niekoľko kombinácií tlačidiel
- kombinácia viacerých stmievačov nie je možná
- pamäť intenzity svetla
- jemná funkcia zapínania/vypínania
- nábehový stmievač
- v súlade s STN EN 60669, STN EN 60950, STN EN 61000, STN ETSI EN 300 220-1, STN ETSI EN 300 220-2
- káblové skrutkové spoje 2,5 mm²

DIMMER INBOX R (250 W), (RC, RL 200 VA)

- in-box, controlled by external push button
- load RLC 15-250W or 15-200 VA
- supply voltage 230V~ 50Hz
- several push-buttons combinations are possible
- more dimmers combination is not allowed
- light intensity memory
- soft start/stop function
- »leading edge«
- in accordance with EN60669, EN60950, EN 61000, ETSI EN 300 220-1, ETSI EN 300 220-2
- screw contacts to wires 2,5 mm²

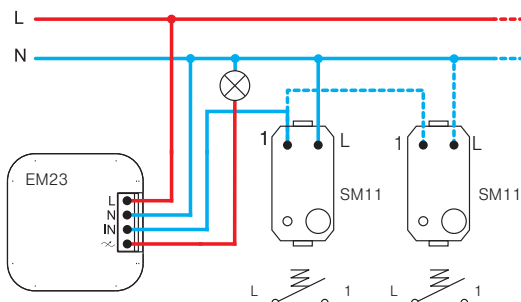
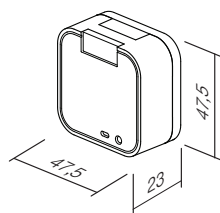



- EM16PW
- EM16MW
- EM16SB
- EM16AT
- EM16ES
- EM16IW



1-10 V STMIEVAČ ROTAČNÝ STRIEDAVÝ

- menovité prevádzkové napätie: 10 VDC
- minimálne prevádzkové napätie: 0,7 VDC
- oblasť stmievania: 0,7 - 100 % (v závislosti na napájaní a zaťažení)
- minimálny odporový prúd: 0,1 mA
- maximálny odporový prúd: 120 mA
- maximálny výkon: 0,35 W
- prepäťová ochrana: 15,8 VDC do 250 mA (nenahradiateľná)
- maximálny impulzný prúd: 3 ADC
- typ záťaží: 0-10 V, 1-10 V a PWM
- typ spínača: mechanický: tlačidlo zapnutie/vypnutie
- nulový vodič: nie je potrebný
- menovité prevádzkové napätie: 100-240 V~, 50-60 Hz
- maximálny aktuálny prúd: 10 A
- maximálny prevádzkový prúd: 8 A
- maximálna záťaž (pri 230 V~): 1800 VA (1800 x pf max. W)
- izolačný odpor: > 100 MΩ pri 250 V~
- prepäťová ochrana a ochrana proti skratu: 10 A, 350 V~ (nenahradiateľná)
- rotačný uhol: 270° ± 5°
- prevádzková teplota: -5 do 40 °C
- skladovacia teplota: -30 do 80 °C
- maximálna teplota krytu: 65 °C
- maximálna vlhkosť: 90 % (bez kondenzácie)
- EMC in imunita: CISPR 15(2008), IEC 61547
- LVD: IEC 60669-1:2017, IEC 60669-2-1:2015

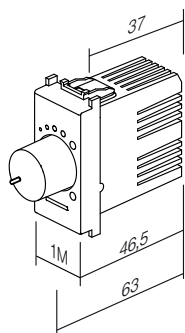

1-10 V DIMMER ROTARY TOGGLE

- nominal operating voltage: 10 VDC
- minimum operating voltage: 0.7 VDC
- dimming range: 0.7% - 100% (depending on power supply and loads)
- minimum sink current: 0.1 mA
- maximum sink current: 120 mA
- maximum consumption: 0.35 W
- surge protection: 15.8 VDC up to 250 mA (not replaceable)
- maximum pulse current: 3 ADC
- load types: 0-10 V, 1-10 V and PWM
- switch type: mechanical: push on/off
- zero cable: not required
- nominal operating voltage: 100-240 V~, 50-60 Hz
- maximum instantaneous current: 10 A
- maximum operating current: 8 A
- maximum load (at 230 V~): 1800 VA (1800 x pf = max. W)
- isolation resistance: > 100 MΩ at 250 V~
- surge protection and Short-circuit protection: 10 A, 350 V~ (not replaceable)
- rotation angle: 270° ± 5°
- operating temperature: -5 to 40 °C
- storing temperature: -30 to 80 °C
- maximum housing temperature: 65 °C
- maximum humidity: 90% (no condensation)
- EMC & immunity: CISPR 15(2008), IEC 61547
- LVD: IEC 60669-1:2017, IEC 60669-2-1:2015

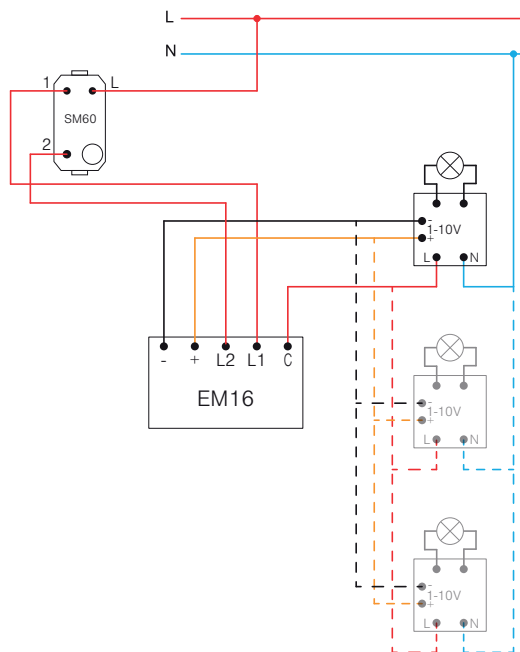
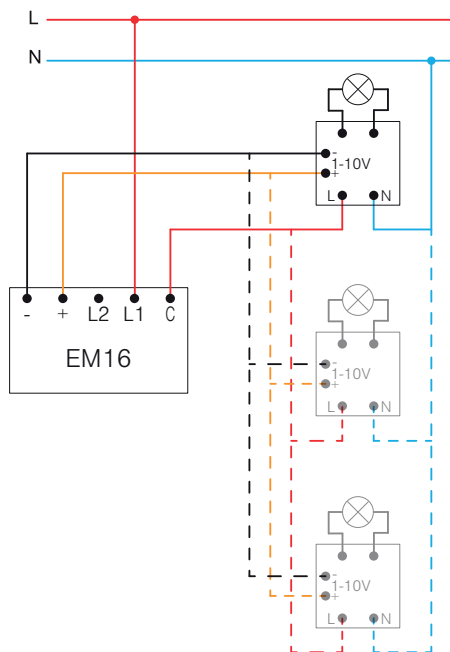

OVĽADACÍ modul MZC pre EM18

EM17

- Pripojte MZC podľa schémy zapojenia.
- Možné prepojenie s viacerými prepínačmi.
- Inštalácia iba jedného zariadenia do jednej krabice.
- Len pre použitie v interiéri.
- Napájanie: 230 V~ 50Hz
- Maximálny odpor vodičov: 50 kΩ
- Maximálny prúd na jednotku MZC: 10 mA
- Počet stmievačov na MZC: 1-4
- Maximálny počet MZC v zapojení: obmedzený na poistku v obvode
- Prevádzková teplota: -5 °C až 45 °C
- Teplota skladovania: -30 °C až 80 °C
- Maximálna vlhkosť: 90 % (bez kondenzácie)
- Rozmery krytu: 36 x 36 x 12 mm

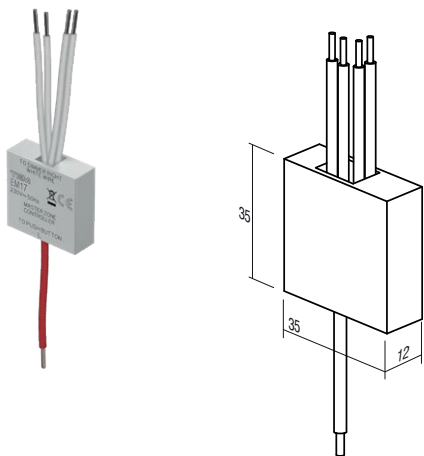

MZC CONTROL Module for EM18

- Connect the MZC according to the wiring diagram.
- Possible wiring with several push buttons.
- Only one device installation per mounting box.
- For indoor use only.
- Power supply: 230V~ 50Hz
- Max. cable resistance: 50kΩ
- Max. current per MZC unit: 10mA
- Number of dimmers on MZC: 1-4
- Max. number of MZC in the wiring: limited to the fuse in the circuit
- Operating temperature: -5°C to 45°C
- Storage temperature: -30°C to 80°C
- Max. humidity: 90% (no condensation)
- Casing dimensions: 36x36x12 mm

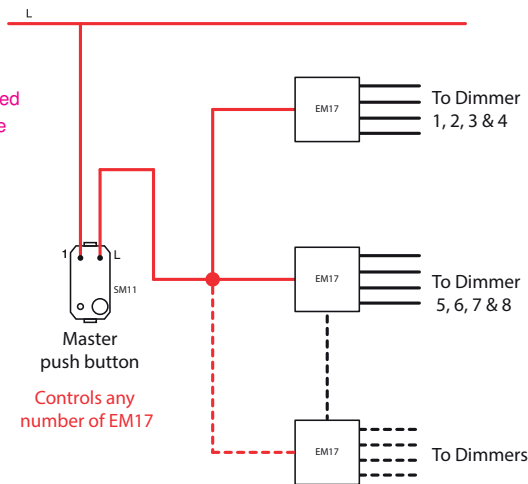
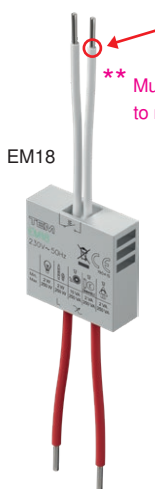
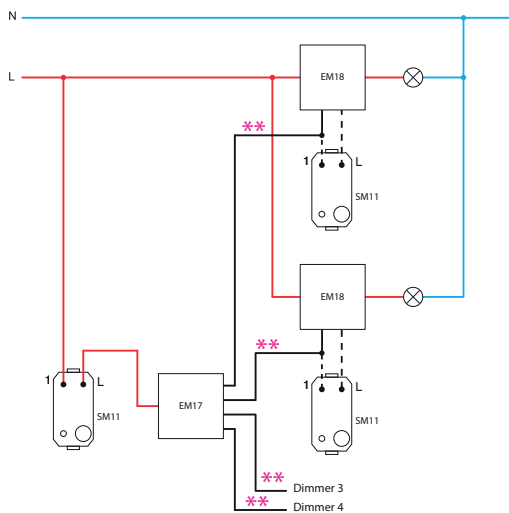

ZABUDOVATEĽNÝ STMIEVAČ LED 250W

EM18

- zabudovateľný, ovládaný vonkajším tlačidlom
- nábehový alebo zostupový stmievač
- napájacie napätie 230 V ~ 50 Hz
- k dispozícii je niekoľko kombinácií tlačidiel
- funkcia zapamätania posledného nastavenia, okrem prípadu výpadku prúdu
- funkcia jemného zapnutia / vypnutia
- nastavenie minimálneho jasu
- inštalácia len jedného stmievača do jednej krabice
- len na použitie v interiéri
- v súlade s EN 60669-1 a EN 60669-2-1



DIMMER INBOX LED 250W

- inbox, controlled by external push button
- for leading or trailing edge
- supply voltage 230V~ 50Hz
- several push-buttons combinations is possible
- memory function of the last setting, except in the case of a power failure
- soft start / stop function
- minimum intensity control
- only one dimmer per wall box
- only for indoor usage
- in accordance with EN 60669-1 and EN 60669-2-1

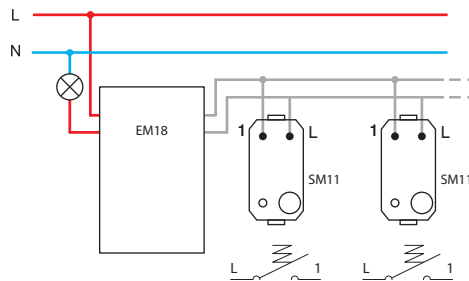
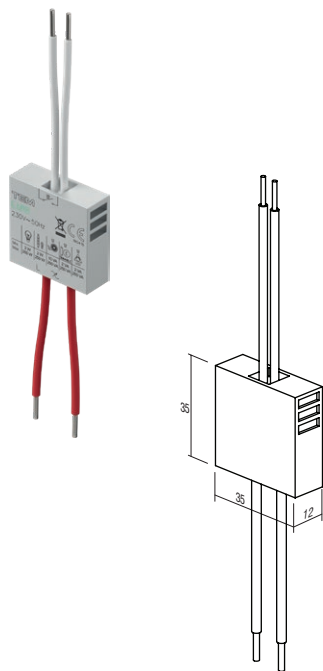

ZABUDOVAŤEL'NÝ STMIEVAČ DC LED 96W

EM19

- zabudovateľný, ovládaný vonkajším tlačidlom
- zapojenie so všetkými LED predradníkmi s konštantným napätím a niektorými LED predradníkmi s konštantným prúdom, 9 - 48 V DC, max 96W (vhodné pre LED pásy)
- nie je určený na použitie s indukčnými záťažami
- možné zapojenie s viacerými tlačidlami a stmievačmi
- funkcia zapamätania posledného nastavenia, okrem prípadu výpadku prúdu
- funkcia jemného zapnutia / vypnutia
- inštalácia len jedného stmievača do jednej krabice
- len pre vnútorné použitie

DIMMER INBOX DC LED 96W

- inbox, controlled by external push button
- for use with constant voltage LED drivers and some constant current LED drivers, 9-48V DC, max 96W (also for LED strips)
- not for use with inductive loads
- several push-buttons combinations and several dimmers is possible
- memory function of the last setting, except in the case of a power failure
- soft start / stop function
- only one dimmer per wall box
- only for indoor usage

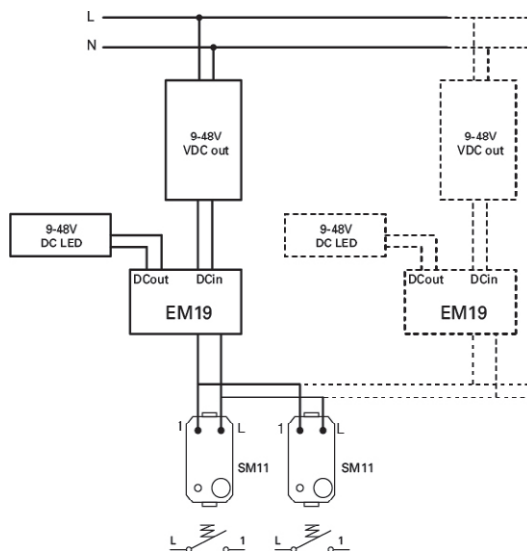
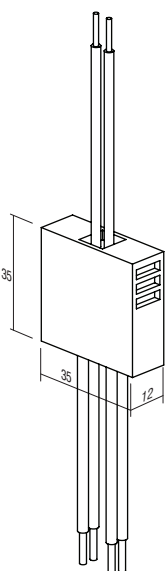

POZOR!

Ak sa do jednej krabice zapojí viac stmievačov, znížte maximálny spoločný výkon o 10 % pri každom stmievači.

ATTENTION!

If more dimmers are connected in one box reduce maximum common power for 10% for each dimmer.

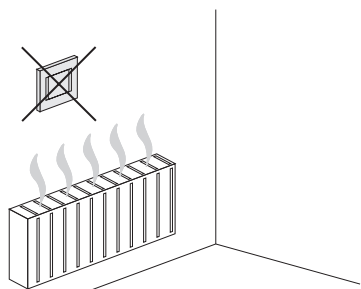

EM15 (40÷250W)

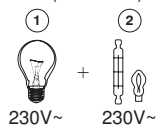

EM12 (40÷300W)

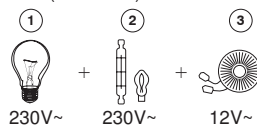

EM13 (0÷60W), EM14 (0÷180W), EM23 (15÷250W, 15÷200VA)

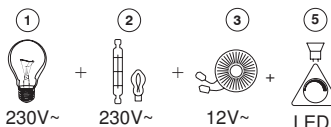

- 1 - žiarovka / incandescent lamp
- 2 - halogénová žiarovka / halogen lamp
- 3 - klasický transformátor / classical transformer
- 4 - stmievaťelný elektronický transformátor / dimmable electronic transformer
- 5 - stmievaťelná LED žiarovka / dimmable LED lamp

EM18 (2÷250VA)

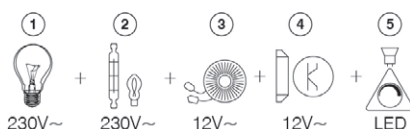

UNIVERZÁLNY STMIEVAČ RLC 0-300 W 2M



- EM25PW
- EM25MW
- EM25SB
- EM25AT
- EM25ES
- EM25IW



TOUCH EM25 je mikroprocesorom riadený elektronický stmievač, ktorý slúži ako prepínač a stmievač pre stmievateľné a niektoré nestmievateľné zdroje svetla. Integrovaný mikroprocesor automaticky identifikuje typ svetelného zdroja a upraví prevádzkový režim. Po vypnutí si vďaka integrovanej pamäťovej funkcii zapamätá úroveň stmienenia. Funkcia jemného zapnutia predlžuje životnosť svetelného zdroja. V tlačidle je zabudovaná elegantná LED indikácia s možnosťou výberu farby a nastavenia intenzity. Je možné pripojiť až 5 ďalších ovládacích tlačidiel EM26 („podriadených“).

TOUCH EM25 is microprocessor controlled electronic light dimmer. It serves as switch and dimmer for dimmable and some of non-dimmable lamps. Integrated microprocessor automatically identifies the type of lamp and adjusts the operating mode. It remembers the level of dimming after switching off due to integrated memory function. Soft-start function extends the lamp service life. An elegant LED indication is integrated into the button and the option of choosing a colour and intensity level is provided. Optionally one can connect of up to 5 additional control tasters EM26 (»slave«).

- univerzálny elektronický stmievač na zapnutie/vypnutie a stmievanie všetkých stmievateľných (klasické, halogénové, LED, CFL, ...) a niektorých nestmievateľných zdrojov svetla
- automatická detekcia typu svetelného zdroja a nastavenie prevádzkového režimu
- znižovanie spotreby energie
- funkcia jemného zapnutia predlžuje životnosť svetelného zdroja
- ovládanie zabudovanými mikrosopínačmi
- súčasťou je pamäťová funkcia – zapamätá si nastavený jas pri vypnutí
- pripojených môže byť päť podriadených ovládacích jednotiek EM26
- spojenie so striedavým prepínačom nie je možné
- zabudovaná ochrana proti skratu, prehriatiu a preťaženiu
- napájacie napätie 230 V ~ 50 Hz
- zabudovaná elegantná LED indikácia s možnosťou výberu farby a nastavenia intenzity
- nahradenie klasického spínača je možné pri dvojvodičovom pripojení⁽¹⁾
- plná funkčnosť sa dosiahne pri trojvodičovom pripojení⁽²⁾
- v súlade s normami EN 60669-1 a STN EN 60669-2-1
- skrutkové upevnenie vodičov 1,5 mm² (max. utahovací moment 0,4 Nm)

SWITCH / DIMMER UNIVERSAL RLC 0-300W 2M

- universal electronic dimmer for ON/OFF switching and dimming of all dimmable lamps (classical, halogen, LED, CFL, ...) and some non-dimmable lamps
- automatic detection of lamp type and adjustment of operating mode
- reduction of energy consumption
- soft start function extends life of lamps
- controlled by build-in micro switches
- memory function included – memorizes brightness on turn-off
- up to five (5) additional control units EM26 can be connected
- connection with 2-way switch is not possible
- build-in short-circuit, overheating and overload protection
- supply voltage 230V~ 50Hz
- an elegant integrated LED indication with the option of setting colour and intensity.
- replacement of classical switch is possible at two-wire connection⁽¹⁾
- full functionality is achieved at three-wire connection⁽²⁾
- in accordance with EN 60669-1 and EN 60669-2-1
- screw contacts 1.5mm² (max. tightening torque 0.4Nm)

⁽¹⁾dvojvodičové zapojenie
two-wire connection

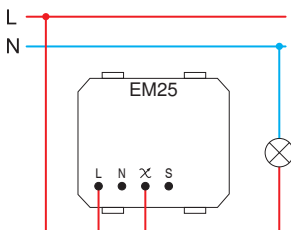

⁽²⁾trojvodičové zapojenie
three-wire connection

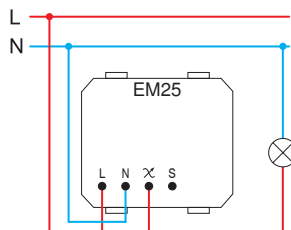

- dvojvodičové zapojenie umožňuje stmievanie stmievateľných žiaroviek a žiaroviek
- two-wire connection allows dimming of dimmable lamps

- trojvodičové zapojenie umožňuje stmievanie stmievateľných žiaroviek a niektorých nestmievateľných LED žiaroviek a CFL žiaroviek
- three-wire connection allows dimming of dimmable lamps and some of non-dimmable LED and CFL lamps

	1	2	5	6	7
Min.	40 W	40 W	40 VA	40 VA	40 VA
Max.	300 W	300 W	300 VA	100 VA	100 VA
	(F)	(F)	(F)		

	1	2	4	6	7	8	9
Min.	0 W	0 W	0 VA	0 VA	0 VA	0 VA	0 VA
Max.	300 W	300 W	120 VA	120 VA	120 VA	120 VA	120 VA
	(F)	(F)	(F)			(F)	(F)

- 1 - žiarovka / incandescent lamp
- 2 - halogénová žiarovka / halogen lamp
- 4 - stmievateľný elektronický transformátor / dimmable electronic transformer
- 5 - klasický transformátor / classical transformer

- 6 - stmievateľná, úsporná CFL žiarovka / dimmable energy saving CFL lamp
- 7 - stmievateľná LED žiarovka / dimmable LED lamp
- 8 - nestmievateľná, úsporná CFL žiarovka / non-dimmable energy saving CFL lamp
- 9 - nestmievateľná LED žiarovka / non-dimmable LED lamp

poznámky / remarks

- (F) filter EM27
 - odporúča sa použiť filter EM27 / it is recommended to use filter EM27
- všetky regulované zdroje svetla musia byť rovnaké / all controlled lamps must be the same
- tabuľka zaťaženi sa týka svetelných zdrojov s účinkom PF > 0,5 / table of loads is valid for lamps with power factor PF>0.5

zapnutie/vypnutie a stmievanie svetla
on / off switching and dimming of lamp

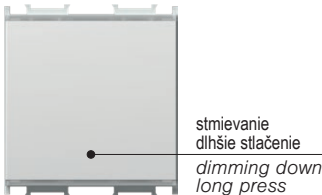
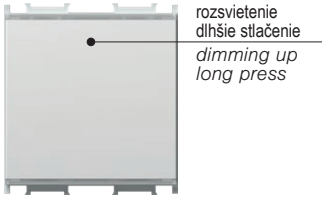
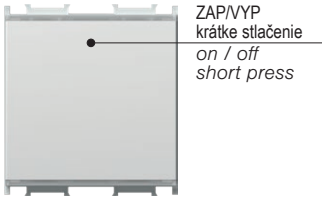

výber farby a nastavenie intenzity LED jednotky /
LED unit colour and intensity level selection

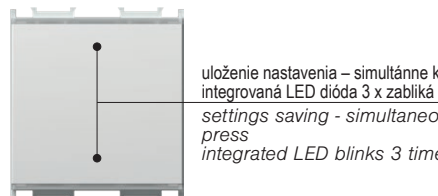
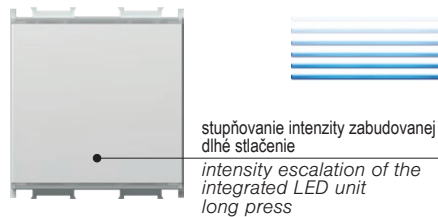
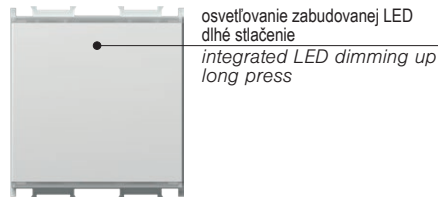
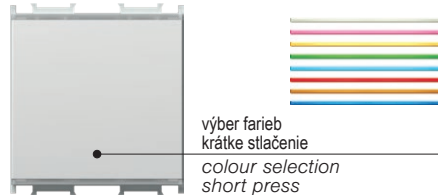
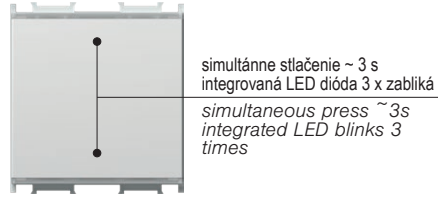
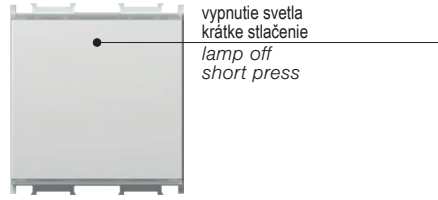

* Funkcia resetovania /
"RESET" function

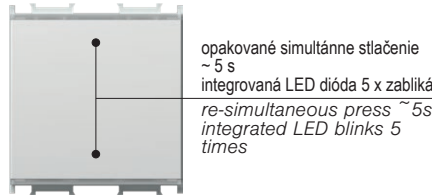
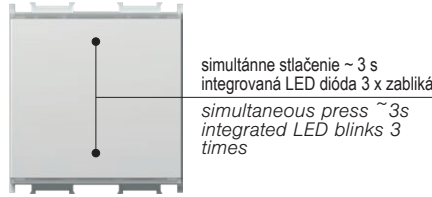
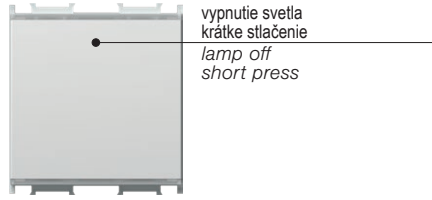

- * - odporúča sa pri inštalácii stmievača a výmene žiarovky / žiarivky
- povinné pri použití nestmievateľných žiaroviek
- funkcia „RESET“ nie je možná pri použití dvojvodičového spojenia
- možné iba na EM25
- it is recommended at dimmer installation and lamp replacement
- mandatory when using non-dimmable lamps
- "RESET" function is not possible when using two-wire connection
- only possible on EM25

upozornenia pre inštaláciu
installation precautions

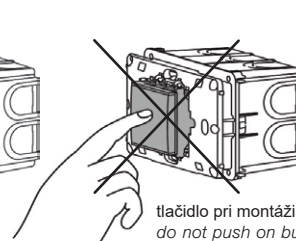
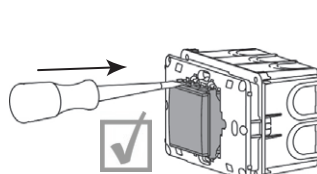
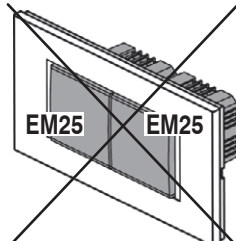
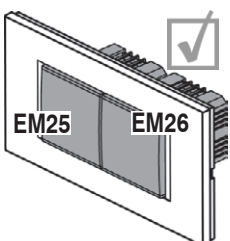

tláčidlo pri montáži nestláčajte /
do not push on button during mounting

OVĽADACIA JEDNOTKA STMIEVAČA 2M

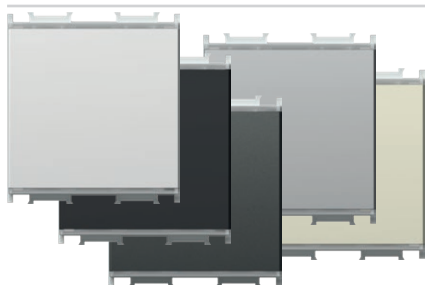

- EM26PW
- EM26MW
- EM26SB
- EM26AT
- EM26ES
- EM26IW

- pripojenie k univerzálnemu stmievaču EM25 umožňuje ovládanie zdrojov svetla s rovnakou funkčnosťou ako EM25
- napájacie napätie 230 V ~ 50 Hz
- v súlade s normami EN 60669-1 a STN EN 60669-2-1
- skrutkové upevnenie vodičov 1,5 mm² (max. uťahovací moment 0,4 Nm)

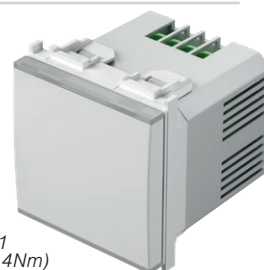

PUSH-BUTTON CONTROL UNIT 2M

- connected to universal dimmer EM25 allows controlling of lamps with same functionality as EM25
- supply voltage 230V~ 50Hz
- in accordance with EN 60669-1 and EN 60669-2-1
- screw contacts 1.5mm² (max. tightening torque 0.4Nm)

(1) dvojvodičové zapojenie
two-wire connection

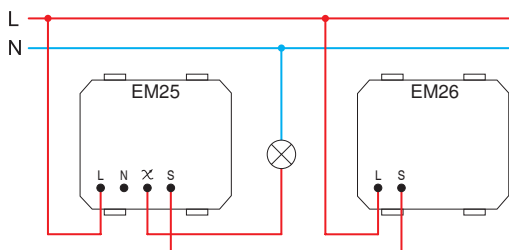

- dvojvodičové zapojenie umožňuje stmievanie stmievateľných žiaroviek a žiaroviek
- v dvojvodičovom zapojení každá ďalšia ovládacia jednotka zvýši minimálne zaťaženie o 25 W

- two-wire connection allows dimming of dimmable lamps
- in a two-wire connection each additional control unit increases the minimum load by 25W

(2) trojvodičové zapojenie
three-wire connection

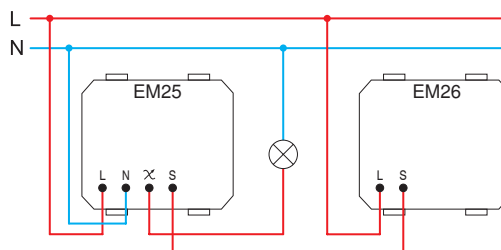

- trojvodičové zapojenie umožňuje stmievanie stmievateľných žiaroviek a niektorých nestmievateľných LED žiaroviek a CFL žiaroviek
- three-wire connection allows dimming of dimmable lamps and some of non-dimmable LED and CFL lamps

UNIVERZÁLNY STMIEVAČ RLC 0-300 W 2M PP OL20

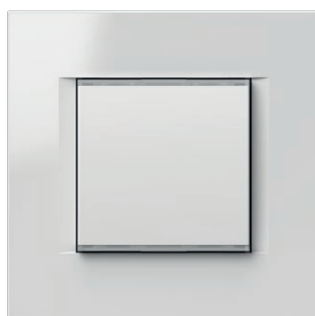

- EM25PPOL20

- súprava obsahuje stmievač EM25, montážny rám 2M a rámk LINE 2M PW
- pre technické podrobnosti pozri EM25

SET SWITCH / DIMMER UNIVERSAL RLC 0-300W 2M PP OL20

- set includes dimmer EM25, mounting frame 2M and cover plate LINE 2M PW
- for technical details see EM25



2M = 45 x 45

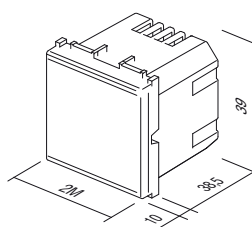

EM25
EM26



EM27

FREKVENČNÝ FILTER

- frekvenčný filter pre EM25
- obrázok je ilustračný

FREQUENCY FILTER

- frequency filter for EM25
- image is symbolic

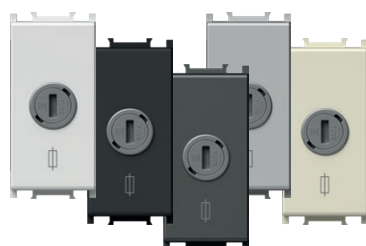
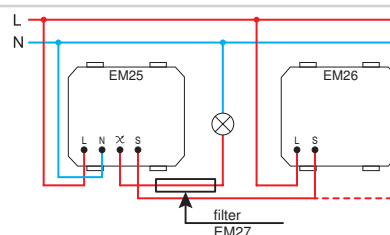

- EM28PW
- EM28MW
- EM28SB
- EM28AT
- EM28ES
- EM28IW

KRABICA POISTKY 230 V~, 50 Hz 1M

- Napájacie napätie: 230 V~, 50 Hz
- Poistka: MAX. 10 A/230 V~, 50 Hz
- Prierez vodiča: 0,75 – 2,5 mm²
- Prevádzková teplota: od 0 do +40 °C
- Skladovacia teplota: od -5 do +60 °C
- Počet pripojení: 2; 1× L, 1× výstup (L)
- Splňa normu: EN 60669-2-1:2004 + A1:2009 + A12:2010 EN 60669-1:2018



MELT FUSE HOUSING 230 V~, 50 Hz 1M

- Supply voltage: 230 V~, 50 Hz (fuse not included)
- Fuse: MAX 10 A / 230 V~, 50Hz
- Wire cross-section: 0.75 - 2.5mm²
- Operating temperature: 0 to +40°C
- Storage temperature: -5 to +60°C
- Number of connectors: 2; 1x L, 1x Output (L')
- Corresponds to the standard: EN 60669-2-1:2004 + A1:2009 + A12:2010 EN 60669-1:2018

POISTKA

EM29

- T5AH 250V, 5x20mm
- balené po 10 kusov

FUSE T5AH

- T5AH 250V, 5x20mm
- packed in packs of 10 pcs



IR SPÍNAČ 5 A 230 V ~ 1M



- EM31PW
- EM31MW
- EM31SB
- EM31AT
- EM31ES
- EM31IW

- infračervený spínač
- napájacie napätie: 230 V ~ ±10 % 50 Hz
- relé: 5 A/250 V (prechod nulou)
- stupeň krytia: IP40
- prierez vodiča na kontaktnej svorke: 0,75 – 2,5 mm²
- uhol detekcie: až 110° pri 20 °C
- detekčná oblasť: pribl. 8 m pri 20 °C
- nastaviteľný čas zopnutia: od pribl. 5s do 12min
- nastaviteľnosť jasu: od pribl. 5 do 200 LUX
- prevádzková teplota: od 0 °C do + 40 °C
- nie je vhodný na montáž do krabíc s hĺbkou 45 mm a do krabice určenej pre povrchovú montáž CUBO IP20
- len pre použitie v interiéri



IR SWITCH 5A 230V~ 1M

- IR infrared switch
- supply voltage: 230V~, ±10 % 50Hz
- relay: 5A / 250V~, (zero crossing)
- protection rating: IP40
- cross-section of wires at the contact terminal: 0.75 - 2.5 mm²
- detection angle: up to 110° at 20°C
- detection area: approx. 8 m at 20°C
- adjustability of duration: from approx. 5 s to 12 min
- adjustability of brightness: from approx. 5 to 200 LUX
- operating temperature: from 0°C to +40°C
- not suitable for installation in 45 mm deep boxes and surface mount box CUBO IP20
- only for indoor usage

IR SPÍNÁČ 5 A 230 V ~ 2M

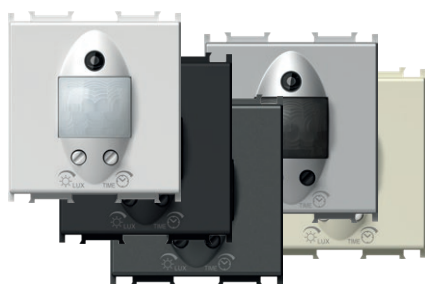

- EM32PW
- EM32MW
- EM32SB
- EM32AT
- EM32ES
- EM32IW



- infračervený spínač
- napájacie napätie: 230 V ~ ±10 % 50 Hz
- relé: 5 A/250 V (prechod nulou)
- stupeň krytia: IP40
- prierez vodiča na kontaktnej svorke: 0,75 – 2,5 mm²
- uhol detekcie: až 110° pri 20 °C
- detekčná oblasť: pribl. 8 m pri 20 °C
- nastaviteľný čas zopnutia: od pribl. 5 s do 12 min
- nastaviteľnosť jasů: od pribl. 5 do 200 LUX
- prevádzková teplota: od 0 °C do +40 °C
- nie je vhodný na montáž do krabíc s hĺbkou 45 mm a do krabice určenej pre povrchovú montáž CUBO IP20
- len pre použitie v interiéri



IR SWITCH 5A 230V~ 2M

- IR infrared switch
- supply voltage: 230V~, ±10 % 50Hz
- relay: 5A / 250V~, (zero crossing)
- protection rating: IP40
- cross-section of wires at the contact terminal: 0.75 - 2.5 mm²
- detection angle: up to 110° at 20°C
- detection area: approx. 8 m at 20°C
- adjustability of duration: from approx. 5 s to 12 min
- adjustability of brightness: from approx. 5 to 200 LUX
- operating temperature: from 0°C to +40°C
- not suitable for installation in 45 mm deep boxes and surface mount box CUBO IP20
- only for indoor usage



- EM33PW
- EM33MW
- EM33SB
- EM33AT
- EM33ES
- EM33IW



SENZOROVÝ SPÍNÁČ 5 A 230 V ~ 1M

- Napájacie napätie: 230 V~, 50 Hz
- Výstup: Relé 5 A/230 V~, 50 Hz
- Prierez vodiča: 0,75 – 2,5 mm²
- Prevádzková teplota: od 0 do +40 °C
- Skladovacia teplota: od -5 do +60 °C
- Funkcie: Nočný spínač, Spínač s detekciou pohybu, Spínač s detekciou prítomnosti
- Indikácia programu: Označenie na prednom kryte
- Počet tlačidiel/ovládacích prvkov: 3
- Typ fungovania tlačidiel/ovládacích prvkov: Rotácia
- Nastaviteľnosť času zapnutia výstupu: Od približne 10 s do 12 minút
- Oblasť detekcie: Približne 8 m
- Uhol detekcie: Do 110°
- Nastaviteľnosť osvetlenia: ~5 až ~200 luxov
- Počet pripojení: 4; 1x N, 1x L, 1x riadený vstup (S)
- Možnosť riadeného vstupu: Áno. Pripojenie signálu sieťového napätia (230 VAC) na svorku S.
- Dodatočne: „Zero Crossing“ (prepínanie napätového spínača cez 0 V)
- Spotreba v režime OFF/ON Splňa normu: 0.3 W / 0.6 W
- EN 60669-2-1:2004 + A1:2009 + A12:2010 EN 60669-1:2018



SENSOR SWITCH 5A 230V~ 1M

- Supply voltage: 230 V~, 50Hz
- Output: Relay 5 A / 230 V~, 50 Hz
- Wire cross section: 0.75 - 2.5 mm²
- Operating temperature: 0 to +40 °C
- Storage temperature: -5 to +60 °C
- Functions: Night switch, Motion detection switch, Presence Detection Switch
- Programme indication: Mark on front cover
- Number of keys/controls: 3
- Operation Type of Key/Control: Rotation
- Adjusting the output activation time: From approx. 10 sec to 12 minutes
- Detection Area: Approximately 8 m
- Detection angle: Up to 110°
- Illumination adjustment: From ~5 to ~200 lux
- Number of connectors: 4; 1x N, 1x L, 1x Output (L'), 1x Controlled input (S)
- Controlled input option: Yes. Connection of the main voltage signal (230 V~) to terminal S.
- Optional: "Zero Crossing" (switching the switch when the voltage passes through 0 V)
- Power consumption in the OFF/ON state Corresponds to the standard: 0.3 W / 0.6 W
- EN 60669-2-1:2004 + A1:2009 + A12:2010 EN 60669-1:2018

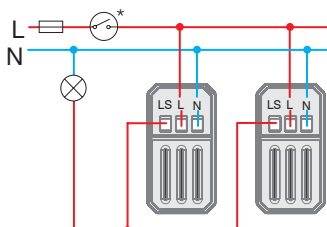

EM31 / EM32

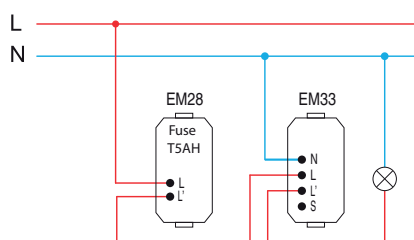

EM33

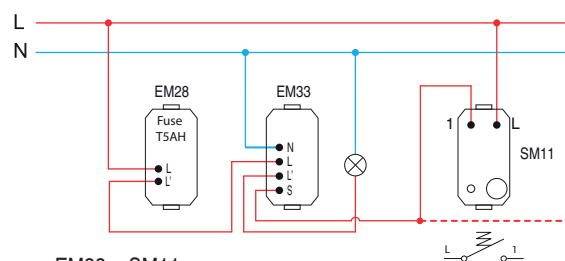

EM33 + SM11

EM31 / EM32

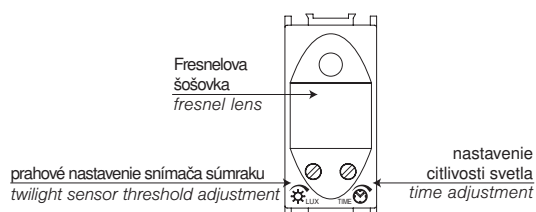

EM33

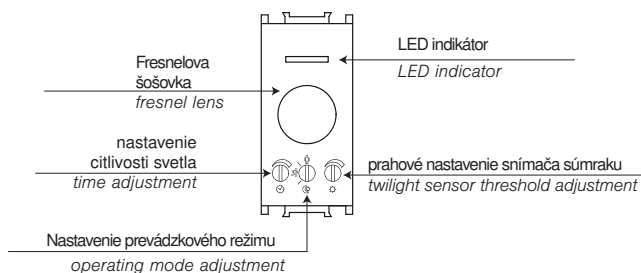
Nastavenie citlivosti a času osvetlenia
time and twilight adjustment

	EM31 / EM32	EM33	EM31 / EM32	EM33
	~ 5 LUX	~ 5 LUX	~ 200 LUX	~ 200 LUX
	~ 5 s	~ 10 s	~ 12 min	~ 12 min

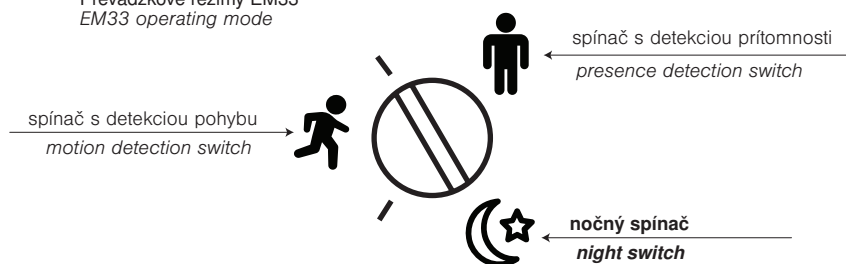
Prevádzkové režimy EM33
EM33 operating modedruh záťaží
types of load

		1	2	3	4	5	6	7	8	9	10
EM31 EM32 EM33	min.	1 W	1 W	—	1 VA	—	—	1 W	1 W	1 VA	1 VA
EM31 EM32	max.	800 W	800 W	5 A	6x20 VA	—	—	6x36 W	4x36 W	6x23 VA	6x20 VA
EM33	max.	1000 W	1000 W	5 A	650 VA	650 VA	2 A	—	—	100 VA	100 VA

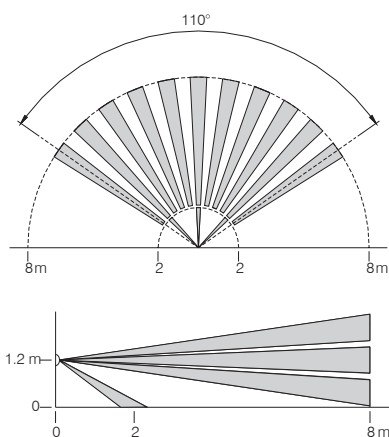
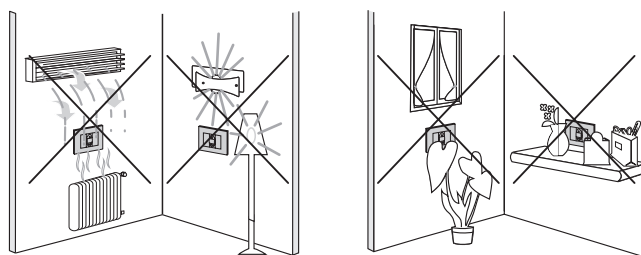
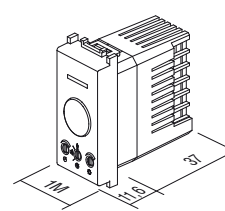
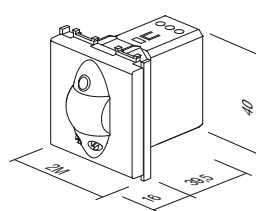
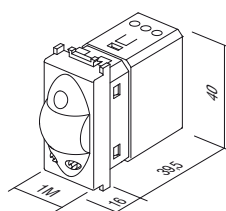
1 – žiarovka /
incandescent lamp2 – halogénová žiarovka /
halogen lamp9 – úsporná CFL žiarivka /
energy saving CFL lamp3 – odporové vykurovacie teleso /
resistive heating element4 – elektronický transformátor /
electronic transformer10 – LED žiarovka /
LED lamp5 – klasický transformátor /
classical transformer6 – motor /
motor7 – žiarivka (verzia 1) /
fluorescent tube (version 1)8 – žiarivka (verzia 2) /
fluorescent tube (version 2)rozsah snímania /
detection rangeupozornenia /
attention1M = 22,5 x 45
2M = 45 x 45

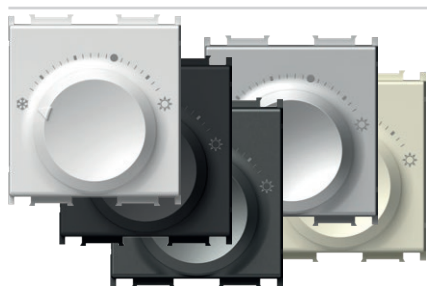

- EM38PW
- EM38MW
- EM38SB
- EM38AT
- EM38ES
- EM38IW

TERMOSTAT VYKUROVANIE 5(2)A 230 V~ 2M

- prevádzkový režim: kúrenie
- napájanie: 230 V~, 50 Hz
- napätový impulz: 4 kV
- príkon: <0,5 W
- výstup: 2 A (max. 5 A); 230 V~, 50 Hz
- výstupné pripojenie: NO (max. 10 pohonov)
- rozsah ovládania: +5 °C až +30 °C
- protimrazová ochrana: +5 °C
- hysterézia: 0,5 K
- ochrana: IP30
- typ snímača: Bimetal
- typ elektrického pripojenia: Pružinové kontakty
- typ vodiča:
- 0,75 - 1,5 mm² (mäkké jadro);
- 1,0 - 2,5 mm² (tvrdé jadro)
- v súlade s DIN EN 60730



HEATING THERMOSTAT 5(2)A 230V~ 2M

- operation mode: heating
- power supply: 230 V~, 50 Hz
- voltage pulse: 4 kV
- energy consumption: < 0.5 W
- output: 2 A (max. 5 A); 230 V~, 50 Hz
- switching output: NO (max. 10 actuators)
- regulation range: +5°C to +30°C
- frost protection: +5°C
- hysteresis: 0.5 K
- protection: IP30
- sensor type: Bimetal
- type of electrical connection: Spring-loaded contacts
- type of conductors: 0.75 – 1.5 mm² (flexible-stranded core);
- 1.0 – 2.5 mm² (solid core)
- in compliance with Directive DIN EN 60730

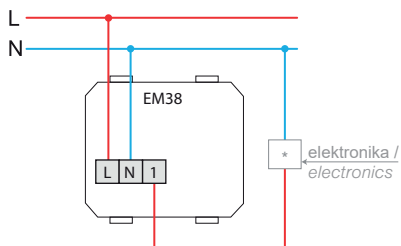

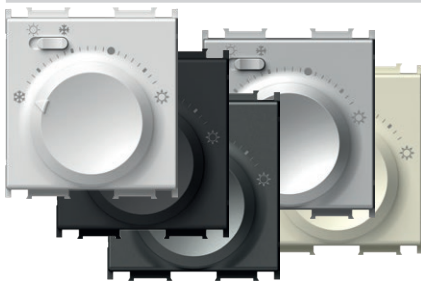

- EM39PW
- EM39MW
- EM39SB
- EM39AT
- EM39ES
- EM39IW

TERMOSTAT VYKUROVANIE/CHLADENIE 3(1,5)A 230 V~ 2M

- prevádzkový režim: kúrenie / chladenie
- napájanie: 230 V~, 50 Hz
- napätový impulz: 4 kV
- príkon: <0,5 W
- výstup: 1,5 A (max. 3 A); 230 V~, 50 Hz
- výstupné pripojenie: pákový spínač (max. 5 pohonov)
- rozsah ovládania: +5 °C až +30 °C
- protimrazová ochrana: +5 °C
- hysterézia: 0,5 K
- ochrana: IP30
- typ snímača: Bimetal
- typ elektrického pripojenia: Pružinové kontakty
- typ vodiča:
- 0,75 - 1,5 mm² (mäkké jadro);
- 1,0 - 2,5 mm² (tvrdé jadro)
- v súlade s DIN EN 60730



HEATING/COOLING THERMOSTAT 3(1.5)A 230V~ 2M

- operation mode: cooling/heating
- power supply: 230 V~, 50 Hz
- voltage pulse: 4 kV
- energy consumption: < 0.5 W
- output: 1 A (max. 3 A); 230 V~, 50 Hz
- switching output: mode selector switch (max. 5 actuators)
- regulation range: +5°C to +30°C
- frost protection: +5°C
- hysteresis: 0.5 K
- protection: IP30
- sensor type: Bimetal
- type of electrical connection: Spring-loaded contacts
- type of conductors: 0.75 - 1.5mm² (flexible-stranded core);
- 1.0 - 2.5 mm² (solid core)
- in compliance with the Directive DIN EN 60730

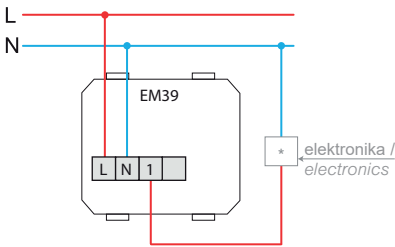

2M = 45 x 45

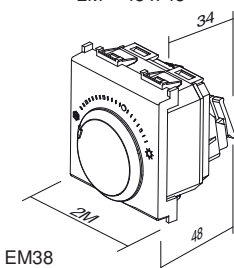

EM38

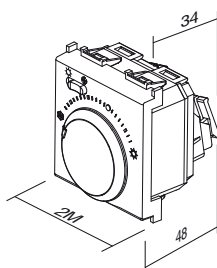

EM39

MONTÁŽNY RÁMIK SO SKRUTKAMI PRE TERMOSTATY FANTINI COSMI 3M

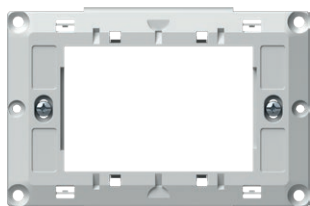

NM39

- montážny rámik so skrutkami pre termostaty Fantini Cosmi 3M
- vhodný na použitie s dennými termostatmi Fantini Cosmi, modely CH121 a CH123
- vhodný na použitie s týždennými termostatmi Fantini Cosmi, modely CH141A a CH143A
- pre montáž do obdĺžnikových krabic 3M
- na montáž s rámikmi rady PURE, Line, Soft

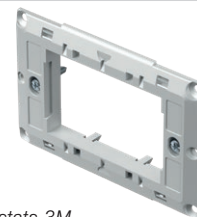

MOUNTING FRAME WITH SCREWS FOR FANTINI COSMI THERMOSTATS 3M

- mounting frame with screws for Fantini Cosmi thermostats 3M
- suitable for use with Fantini Cosmi daily thermostats models CH121 and CH123
- suitable for use with Fantini Cosmi weekly thermostats models CH141A and CH143A
- for mounting in rectangular boxes 3M
- suitable for assembling with cover plates PURE, Line, Soft

KARTOVÝ SPÍNAČ 16 A / 230 V~, 50 Hz 3M



- EM46PW
- EM46MW
- EM46SB
- EM46AT
- EM46ES
- EM46IW

- Napájacie napätie: 230 V~, 50 Hz
- Výstup: Relé 16 A / 230 V~, 50 Hz
- Prierez vodiča: 0,75 – 4,0 mm²
- Prevádzková teplota: 0 do +40 °C
- Skladovacia teplota: -5 do +60 °C
- Funkcia: Kartový spínač s oneskoreným vypnutím
- Oneskorené vypnutie: ~23 s
- Počet pripojení: 6; 2x N, 2x L a 2x výstup (C a NO)
- Spotreba v stave OFF/ON: 0,5 W/1,2 W



CARD SWITCH 16 A / 230 V~, 50 Hz 3M

- Supply voltage: 230 V~, 50 Hz
- Output: Relay 16 A / 230 V~, 50 Hz
- Wire cross-section: 0.75 - 4.0 mm²
- Operating temperature: 0 to +40 °C
- Storage temperature: -5 to +60 °C
- Function: Card switch with a delayed break
- Break delay: ~23 s
- Number of ports: 6; 2x N, 2x L and 2x output (C and NO)
- Power consumption in the OFF/ON state: 0.5 W / 1.2 W

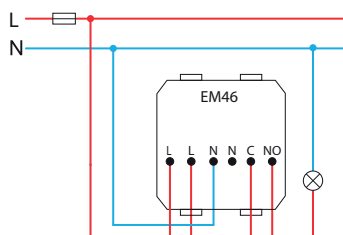
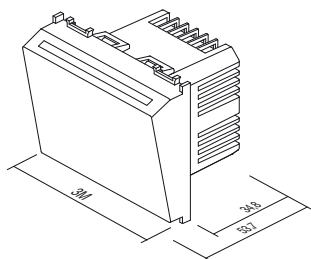



■ EM44BK

KARTOVÝ SPÍNAČ JEDNOTKY PRE ÚSPORU ENERGIE RF HF 13,56 MHz 3M

- elektronický kartový spínač pre kartu ISO RFID
- napájanie z relé jednotky EM49 cez káblové konektory RJ12
- výstup pre pripojenie na jednotku reléového výstupu EM49
- 15-20s oneskorenie vypnutia „hlavného napájania“ po vytiahnutí karty
- 1-minútové oneskorenie vypnutia VZT po vybratí karty, ak sú balkónové dvere alebo okná otvorené
- v súlade s normou EN 61000-6-1
- karta nie je priložená
- nie je určené na riadenie vstupu

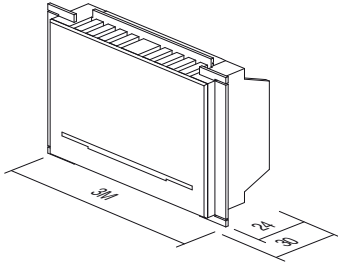

ENERGY SAVER CARD SWITCH RF HF 13,56MHz 3M

- electronic card switch for RFID ISO card
- supply from relay unit EM49 through cable connectors RJ12
- output to be connected to relay output unit EM49
- 15-20s "main power" switch off delay with card withdrawal
- 1 min "HVAC" switch off delay with card withdrawal when balcony doors or windows opened
- in accordance with EN 61000-6-1
- card is not included
- not for access control

KARTA ISO

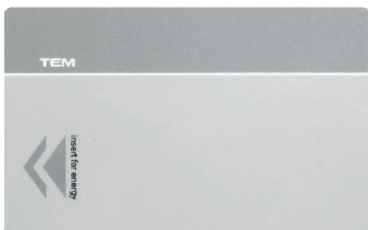

EM47

- ISO karta
- na použitie s kartovým spínačom EM46
- veľkosť: 85 x 54 mm

CARD ISO

- ISO card
- for combination with card switch EM46
- size: 85x54 mm

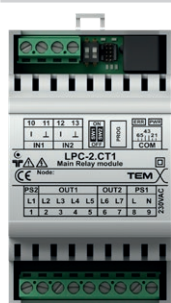

EM49

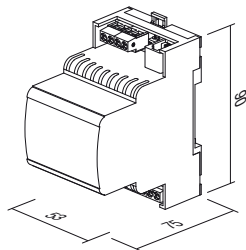

OVLÁDAČ JEDNOTKY PRE ÚSPORU ENERGIE 2 x 16 250 V~

- relé jednotka pre kartové vypínače EM44
- napájacie napätie 230 V ~ 50 Hz
- v súlade s normou EN 61000-6-1
- montáž na DIN 35 mm lištu, 3MU
- vstup a výstup v závislosti na realizácii: jedna miestnosť alebo dve miestnosti

ENERGY SAVER CONTROL UNIT 2x16A 250V~

- relay unit for card switches EM44
- supply voltage 230V~ 50Hz
- in accordance with EN 61000-6-1
- mounting on DIN rail 35mm, 3MU
- input and output depending on implementation: single or double room



EM45

ROZDEĽOVAČ SPL-1

- slúži na pripojenie dvoch periférnych modulov EM44 k relé jednotke EM49
- komunikačný konektor RJ12
- veľkosť: 37 x 30 x 27 mm

SPLITTER SPL-1

- used to connect two peripheral modules EM44 to relay unit EM49
- communication connector RJ12
- size: 37 x 30 x 27 mm

schéma zapojenia pre realizáciu v jednej miestnosti / wiring diagram for single room implementation



schéma zapojenia pre realizáciu v dvoch miestnostiach / wiring diagram for double room implementation



kábel RJ12 pre prepojenie EM44 a EM49 / connection cable RJ12 between EM44 and EM49

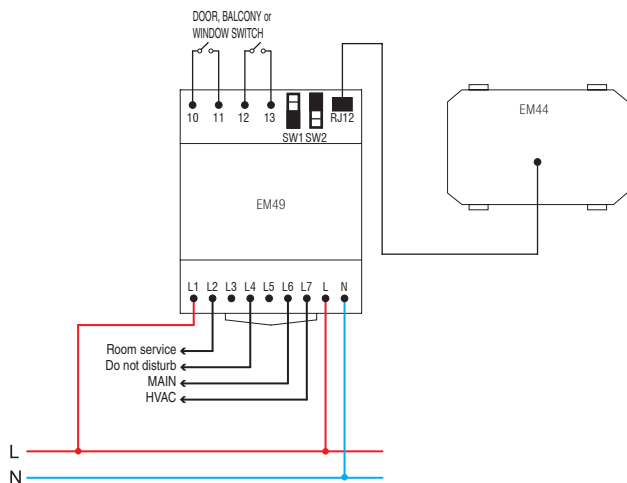
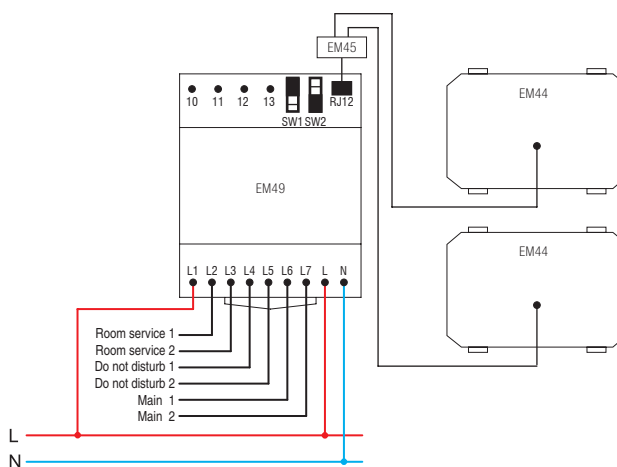
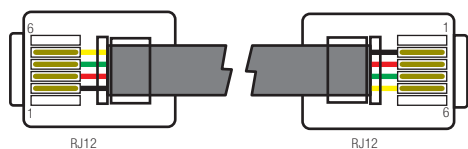

ZÁSUVKA NA HOLIACI STROJČEK 230 V ~/120 V ~ 3M

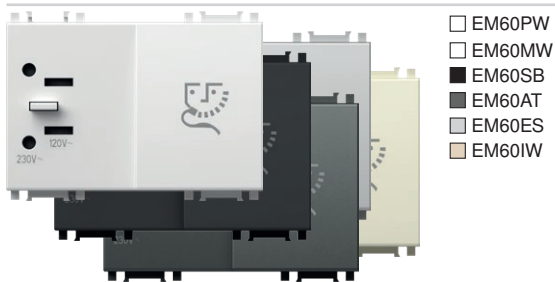

- EM60PW
- EM60MW
- EM60SB
- EM60AT
- EM60ES
- EM60IW

- jednotka napájania holiaceho strojčeka s izolačným transformátorom 20 VA
- napájanie: 230 V ~ 50– 60 Hz
- výkon: 230 V ~ pre európsku zástrčku 2P 2,5 A alebo 120 V ~ pre americkú zástrčku 2P 15 A
- trieda II
- v súlade s normou EN 61558-2-5



SOCKET SHAVER 230V~/120V~ 3M

- shaver supply unit with isolating transformer 20VA
- supply: 230V~ 50-60Hz
- output: 230V~ for 2P 2.5A Europlug or 120V~ for 2P 15A American plug
- Class II
- in accordance with EN 61558-2-5

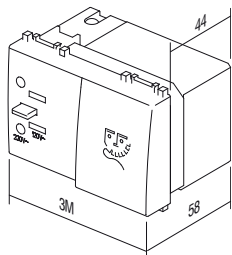

3M = 67,5 x 45

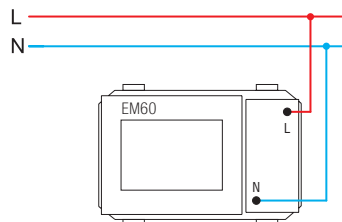

EM57

LED NÚDZOVÉ OSVETLENIE 230 V ~ 0,5W, NiMH 2 h 2M

- núdzový svetelný LED zdroj
- použiteľné ako prenosné ručné svetidlo (vyťahovací mechanizmus)
- napájacie napätie 230 V ~ 50 Hz 1 x LED 0,5 W
- NiMH akumulátor 3,6V 140 mAh, vymeniteľný
- autonómny režim 2hod, nabíjanie 36 hod.
- trieda II
- v súlade s normami EN60598-1, EN60598-2-2, EN62471, EN55015:2006, EN61547 EN 60598-2-22

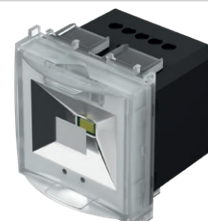

LED EMERGENCY LIGHT 230V~50Hz, 0.5W, NiMH 2h 2M

- emergency LED lamp
- option to use it as a hand lamp (pull-out mechanism)
- supply voltage 230V~50Hz, 1xLED 0.5W
- NiMH accumulator 3,6V 140mAh, replaceable
- autonomy 2h, charging 36h
- class device II
- in accordance EN60598-1, EN60598-2-2, EN62471, EN55015:2006, EN61547

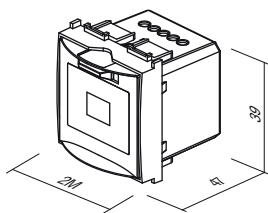
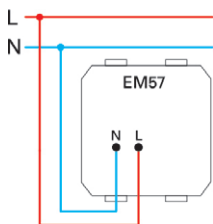



□ EM55

LED NÚDZOVÉ OSVETLENIE 250 V ~ 0,9W, Ni-Cd 3 h 7M

- núdzový svetelný LED zdroj
- napájacie napätie 250 V ~ 50 Hz 3 x LED 0,3 W 10000mcd, 6500K
- NiCd akumulátor 4,8V 400 mAh, vymeniteľný
- autonómny režim 3hod, nabíjanie 24 hod.
- trieda II
- v súlade s normami EN 60598-1, STN EN 60598-2-2, EN 60598-2-22



LED EMERGENCY LIGHT 250V~ 0.90W, NiCd 3h 7M

- emergency LED lamp
- supply voltage 250V~ 50Hz 3x LED 0,3W, 10000mcd, 6500K
- NiCd accumulator 4,8V 400 mAh, replaceable
- autonomy 3h, charging 24h
- Class II
- in accordance with EN 60598-1, EN 60598-2-2, EN 60598-2-22

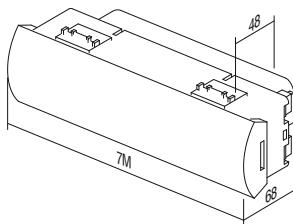

7M = 157 X 45

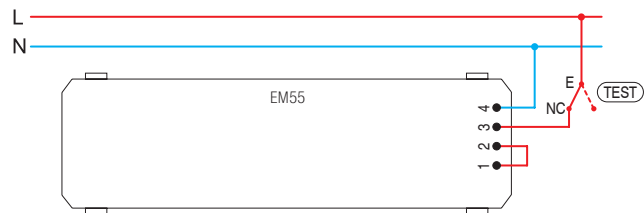



- EM69PW
- EM69MW
- EM69SB
- EM69AT
- EM69ES
- EM69IW

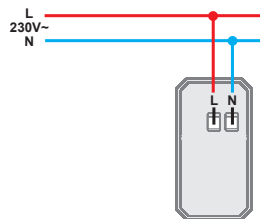
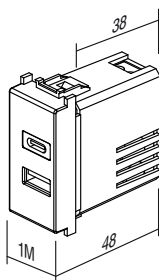

NABIJAČKA USB PD 20 W

- USB napájací zdroj s napájaním do 20 W.
- na nabíjanie elektronických zariadení cez štandardný USB port (kompatibilné aj so zariadeniami Apple)
- napájanie: 100 – 230 V~ 50/60 Hz
- spotreba počas prevádzky: 420 mA pri 100 V~/220 mA pri 230 V~
- spotreba v pohotovostnom režime: < 100 mW pri 230 V~
- výstupné napätie: 20 W Max
- Výstup:
 - USB typ C: 5,0 VDC 3,0 A; 9,0 VDC 2,2 A; 12,0 VDC 1,67 A (PD 20 W)
 - USB typ A: 5,0 VDC 3,0 A; 9,0 VDC 2,0 A; 12,0 VDC 1,5 A (QC 18 W)
 - USB A + C: 5 VDC 3 A
- typ konektora: 1x USB A; 1x USB C
- priemerná účinnosť v aktívnom stave: 86 %
- účinnosť pri minimálnom zaťažení (10 %): 81 %
- prevádzková teplota: 0 °C/+ 45 °C (použitie v interiéri)
- trieda ochrany IP: - IP20, na použitie len v interiéri
- zariadenie bezpečnostnej triedy II
- prepäťová ochrana (EN 60364-4-44): trieda III
- skrutkové upevnenie vodičov max. 2,5 mm²
- zariadenie s posunom kontaktov min. 3 mm
- nie je vhodný na montáž do krabíc s hĺbkou 45 mm a krabice CUBO IP20
- Vyhovuje:
 - Smerniciam: BT, EMC, RoHS, ErP
 - Standardom: EN IEC 62368-1, EN 55032, EN55035, EN IEC 61000-3-2, EN 61000-3-3, EN 50563, EN IEC 63000
 - Dalším predpisom: (EU) n. 2019/1782 REACh, n. 1907/2006 – art.33. Výrobok môže obsahovať stopy olova.



USB POWER SUPPLY UNIT PD 20W

- 20 W USB power delivery power supply unit
- for charging of electronic devices via a standard USB port (also compatible with Apple devices)
- power supply: 100-230V~ 50/60Hz
- power consumption: 420mA at 100V~/220mA at 230V~
- standby power consumption: <100mW at 230V~
- Output power: 20 W Max
- Output:
 - USB tip C: 5.0 VDC 3.0A; 9.0 VDC 2.2 A; 12.0 VDC 1.67 A (PD 20W)
 - USB tip A: 5.0 VDC 3.0A; 9.0 VDC 2.0 A; 12.0 VDC 1.5 A (QC 18W)
 - USB A+C: 5 VDC 3A
- connector type: 1x USB A; 1x USB C
- average efficiency in active mode: 86%
- efficiency with low load (10%): 81%
- operating temperature: 0°C/+45°C (indoor use)
- IP protection class: IP20, indoor use only
- class device II
- overvoltage category (EN 60364-4-44): Class III
- screw contacts: max. 2.5 mm²
- device with a contact gap of at least 3mm
- Conformity:
 - Directive: BT, EMC, RoHS, ErP
 - Standards: EN IEC 62368-1, EN 55032, EN55035, EN IEC 61000-3-2, EN 61000-3-3, EN 50563, EN IEC 63000
 - External power supplies regulation: (EU) n. 2019/1782 REACh, n. 1907/2006 – art.33. The product may contain traces of lead.

LED AMBIENTNÁ JEDNOTKA JEDNOFAREBNÁ 250 V ~ 0,8 W 2M

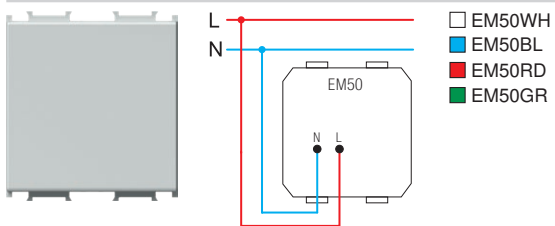

- LED svietidlo pre osvetľovanie schodísk alebo chodieb
- napájacie napätie 230 V ~ 50 Hz 0,8 W, 6500K
- trieda II
- v súlade s normou EN 60598-1
- využitie aj pre orientačné alebo signalizačné osvetlenie s možnosťou laserovej tlače tubovohného symbolu

LED AMBIENT UNIT MONOCOLOUR
250V~ 0,8W 2M

- step marker LED unit
- supply voltage 230V~ 50Hz 0,8W, 6500K
- Class II
- in accordance with EN 60598-1
- optional usage for directional signalization with customized laser printing on diffuser



SVIETIDLO LED DVOJFAREBNÉ 250 V ~ 2 x 0,4 W 2M

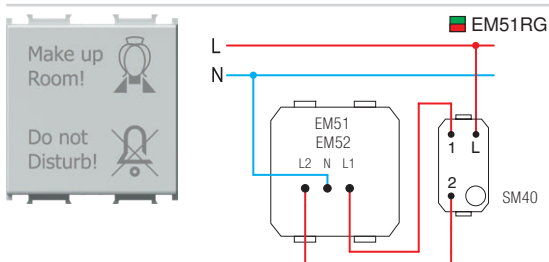

- signalizačné, dvojfarebné (červeno-zelené) LED svietidlo
- napájacie napätie 230 V ~ 50 Hz 2 x 0,4 W, 6500K
- trieda II
- v súlade s normou EN 60598-1
- difúzor obsahuje grafiku, ako je zobrazené na obrázku
- možnosť laserovej tlače na difúzore

LED LAMP DUAL COLOR 250V~ 2x0,4W 2M

- signaling dual color (red/green) LED lamp
- supply voltage 230V~ 50Hz 2x0,4W, 6500K
- Class II
- in accordance with EN 60598-1
- diffuser includes graphics as shown
- possible customized laser printing on diffuser



3D SVIETIDLO LED DVOJFAREBNÉ 250 V ~ 2 x 0,4 W 2M

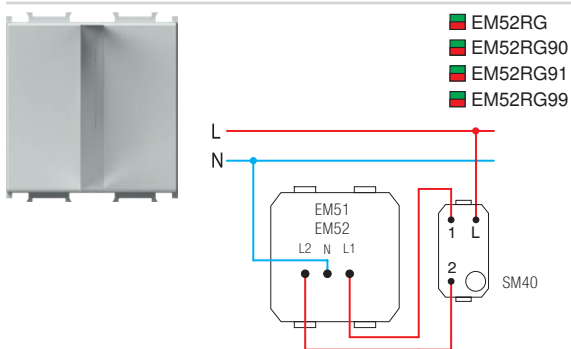

- signalizačné LED svietidlo, dvojfarebné (červeno-zelené) s 3D symbolom
- napájacie napätie 230 V ~ 50 Hz 2 x 0,4 W, 6500K
- trieda II
- v súlade s normou EN 60598-1
- prispôbitelná grafika na vyžiadanie
- 90 symbol muž, 91 symbol žena, 99 symbol na vyžiadanie

LED LAMP 3D DUAL
COLOR 250V~ 2x0,4W 2M

- signalling LED lamp, dual color (red/green) with 3D symbol
- supply voltage 230V~ 50Hz 2x0,4W, 6500K
- class II
- in accordance with EN 60598-1
- possible customized graphics on request
- 90 male symbol, 91 female symbol, 99 symbol on request

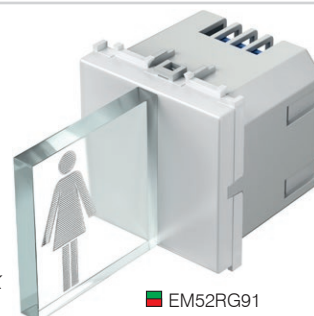

EM52RG91



EM52RG90

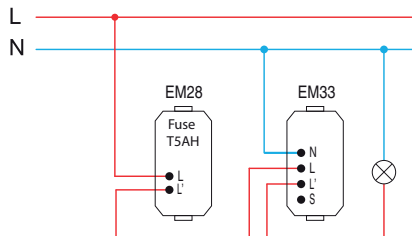
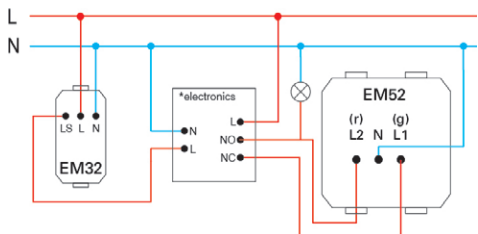

2M = 45 x 45

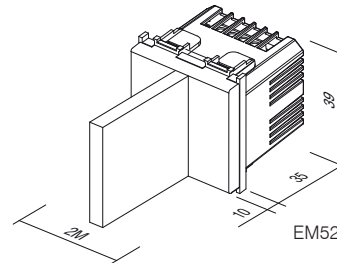
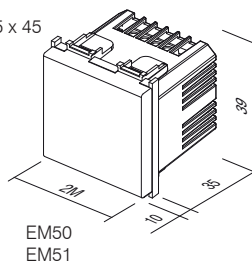

SPÍNAČ NA ODTLAČKY PRSTOV BIOPASS 2M

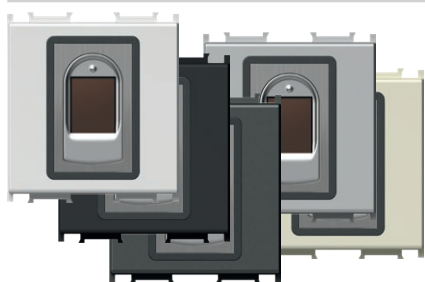

- EM71PW
- EM71MW
- EM71SB
- EM71AT
- EM71ES
- EM71IW

- spínač na odtlačky prstov so zabudovanou vnútornou relé jednotkou a napájaním
- kapacita: 500 odtlačkov prstov
- jednoduché používanie prostredníctvom mobilnej aplikácie X-Manager
- napájacie napätie: 8-30 V – DC alebo AC (napájací zdroj priložený)
- kapacitný snímač
- 2x výstupné relé
- maximálne napätie/prúd na relé: 40V/3A
- čas spustenia relé: 1 - 10 s
- maximálny výkon: 3,6 W
- 256-bitové šifrovanie spojenia medzi spínačom a vnútornou relé jednotkou
- súprava obsahuje aj montážny rám NM24 a dekoratívny rámk OS20

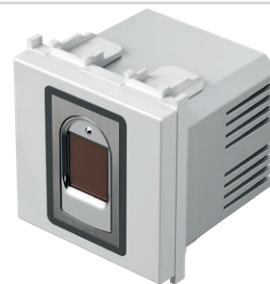

FINGERPRINT SWITCH BIOPASS 2M

- fingerprint switch with included internal relay unit and power supply
- capacity: 500 fingerprints
- easy management via X-Manager mobile app
- power supply voltage: 8-30V – DC or AC (power supply included)
- capacitive sensor
- 2 output relays
- maximum voltage/current on relay: 40V/3A
- relay triggering time: 1-10 sec
- maximum power: 3.6W
- 256-bit encrypted link between switch and internal relay unit
- Set also includes NM24 mounting frame and OS20 decorative cover plate.

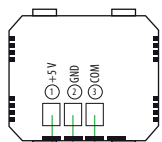

vonkajšia jednotka exterior unit

vnútorná relé jednotka interior relay unit

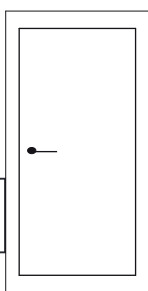
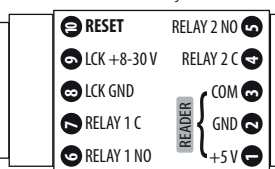

elektrický zámok electric lock

X-Manager app



vonkajšia jednotka exterior unit

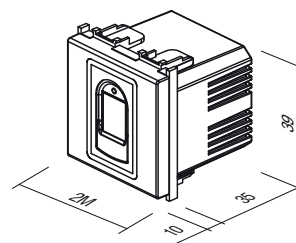



- EM82PW
- EM82MW
- EM82SB
- EM82AT
- EM82ES
- EM82IW



MULTIFUNKČNÝ ČASOVÝ SPÍNAČ EM82

- Napájacie napätie: 230 V~, 50Hz
- Výstup: Relé 16 A / 250 V~, 50 Hz
- Prierez vodiča: 0,75 – 4,0 mm²
- Prevádzková teplota: 0 do + 40 °C
- Skladovacia teplota: -5 do + 60 °C
- Funkcie: **Časovač, Relé (riadený spínač), Spínač, Tlačidlo**
- Indikácia programu / stavu: RGB LED
- Počet tlačidiel: 2
- Druh prevádzky tlačidla: Kapacitne
- Počet pripojení: 6 - 2x N, 2x L, 1x Riadený vstup (S)
- Možnosť riadeného vstupu: Áno. Pripojenie signálu sieťového napätia (230 V~) na svorku S.
- Implementovaná prevádzka »prechod nulou« (prepnutie spínača pri prechode napätia cez 0 V)
- Spotreba v stave OFF / ON: 0,3 W / 0,7 W
- Spínač EM82 NIE JE VHODNÝ na inštaláciu do 45 mm hlbokých podmietskových krábíc a krábíc CUBO IP20.
- Spínač je určený na použitie v interiéri chránenom pred vlhkosťou.

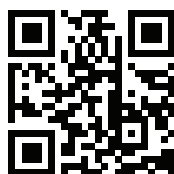

MULTIPURPOSE TIMER SWITCH EM82

- Supply voltage: 230 V~, 50Hz
- Output: Relé 16 A / 250 V~, 50Hz
- Wire cross section: 0,75 – 4,0 mm²
- Operating temperature: 0 to + 40 °C
- Storage temperature: -5 to + 60 °C
- Functions: **Timer, Relay (controlled switch), Switch, Push button**
- Program/status indication: RGB LED
- Number of buttons: 2
- Push button operation type: Capacitive
- Number of ports: 6 - 2x N, 2x L, 1x Controlled input (S)
- Controlled input option: Yes. Connection of the main voltage signal (230 V~) to terminal S.
- Implemented "zero crossing" operation (switching the switch when the voltage passes through 0 V)
- Power consumption in the OFF / ON state: 0.3 W / 1.0 W
- The EM82 switch is NOT SUITABLE for installation in concealed boxes with a depth of 45 mm and CUBO IP20 housing.
- The switch is intended for indoor use, protected from moisture.

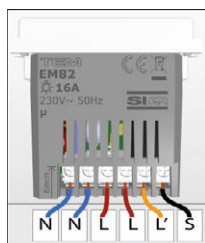
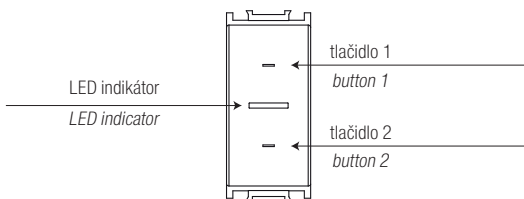

- N Neutrálny vodič
- L Fázový vodič
- L' Výstup (riadená fáza)
- S Vstupný riadiaci signál (230 V~)

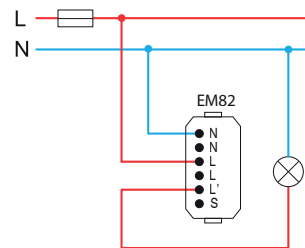

EM82 is in a SWITCH or a TIMER mode

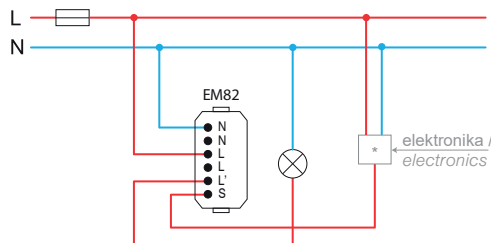

EM82 is in a RELAY mode

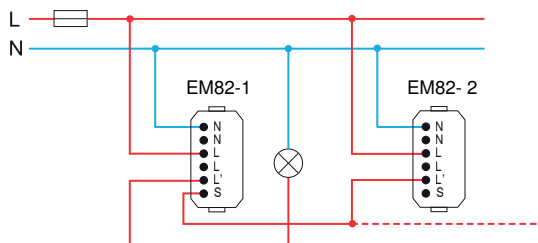

EM82-1 is in a SWITCH or a TIMER mode
EM82-2 is in a PUSH BUTTON mode

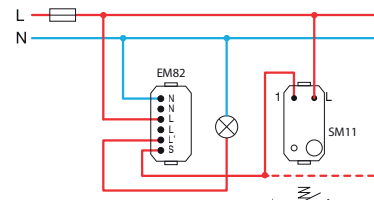

EM82 is in a SWITCH or a TIMER mode

	1	2	3	4	5	6	7	8
Max.	16 A	16 A	16 A	8 A	8 A	5 A cos φ=0.6	200 VA	200 VA

- 1 - incandescent lamp
- 2 - halogen lamp
- 3 - resistive heating element
- 4 - electronic transformer
- 5 - classical transformer
- 6 - motor
- 7 - energy saving CFL lamp
- 8 - LED lamp

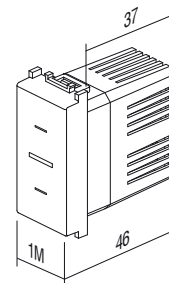

Operation of the control signal S – MODE 1

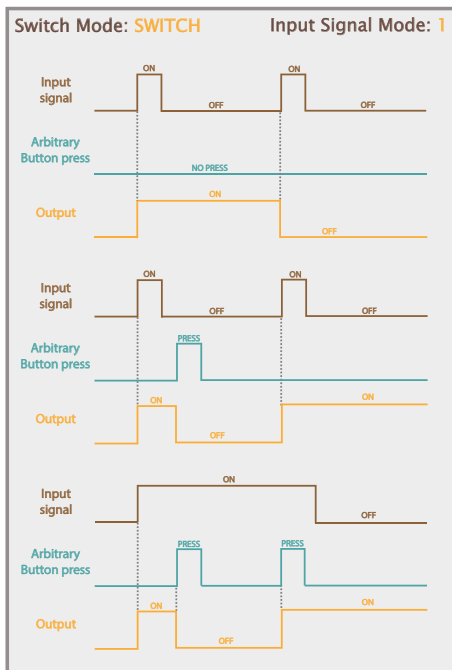

Display of the operation of the external signal S and buttons in the SWITCH operating mode and external signal in MODE 1

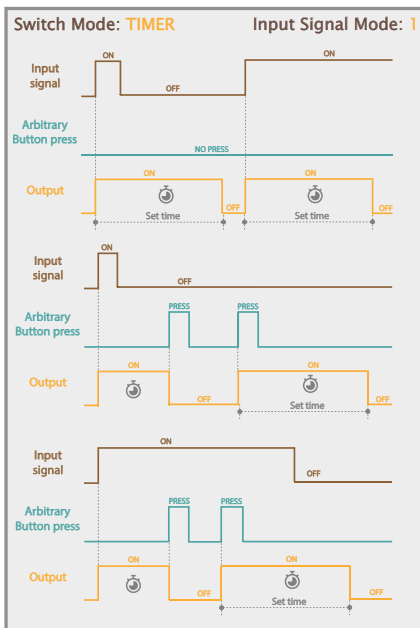

Display of the operation of the external signal S and buttons in the TIMER operating mode and external signal in MODE 1

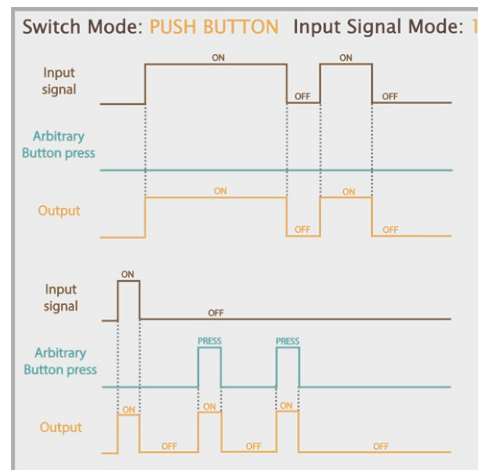

Display of the operation of the external signal S and buttons in the PUSH BUTTON operating mode and external signal in MODE 1

OPERATION OF THE CONTROL SIGNAL S – MODE 2

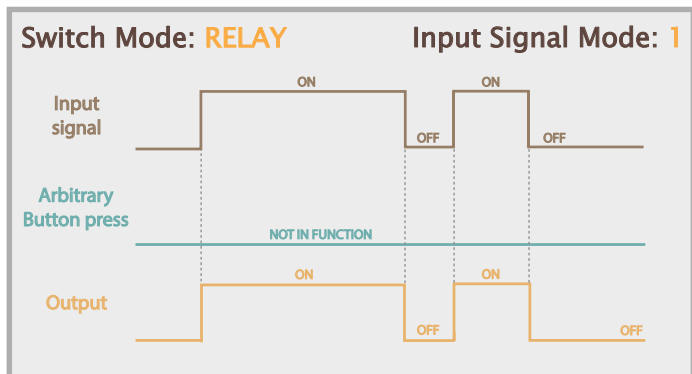

Display of the operation of the external signal S and buttons in the RELAY operating mode and external signal in MODE 1

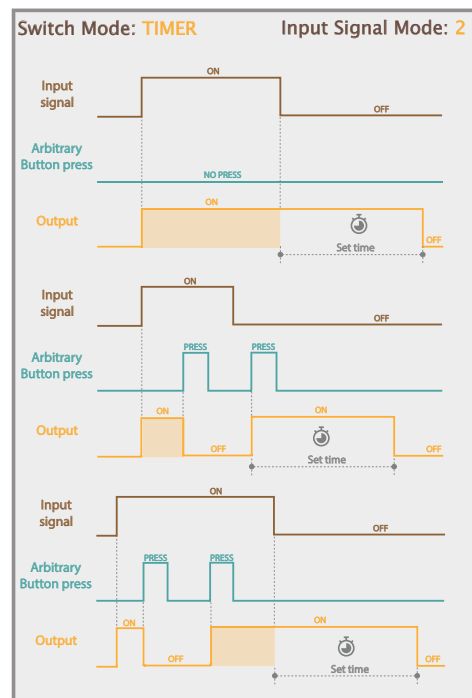

Display of the operation of the external signal S and buttons in the TIMER operating mode and external signal in MODE 2

Operating mode settings of the external control signal S

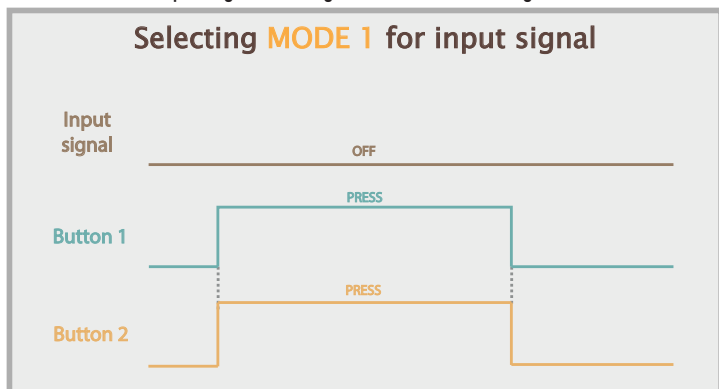

Setting the operating mode of the input signal S for MODE 1

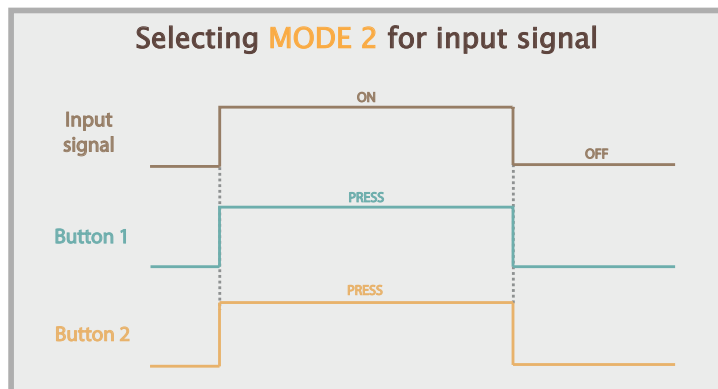

Setting the operating mode of the input signal S for MODE 2

BZUČIAK 8 VA 230 V ~ 1M

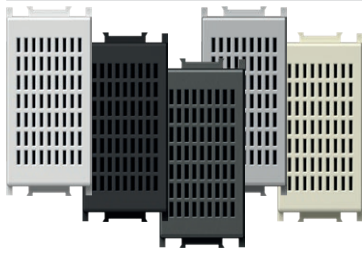

- EM90PW
- EM90MW
- EM90SB
- EM90AT
- EM90ES
- EM90IW

- signálny bzučiak
- dĺžka zvukového signálu je rovnaká ako dĺžka stlačenia tlačidla
- napájacie napätie 230 V~ 50 Hz 8 VA

BUZZER 8VA 230V~1M

- signal buzzer
- the sound emission has the same lasting time as the control operation
- supply voltage 230V~ 50Hz 8VA



BZUČIAK 8 VA 230 V ~ 1M

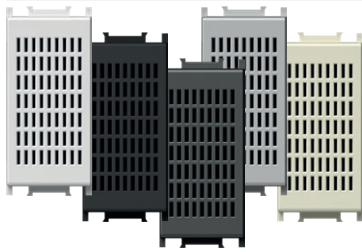

- EM91PW
- EM91MW
- EM91SB
- EM91AT
- EM91ES
- EM91IW

- signálny bzučiak
- dĺžka zvukového signálu je rovnaká ako dĺžka stlačenia tlačidla
- napájacie napätie 230 V~ 50 Hz 8 VA

BUZZER 8VA 12V~1M

- signal buzzer
- the sound emission has the same lasting time as the control operation
- supply voltage 12V~ 50Hz 8VA



ZVONČEK 8 VA 230 V ~ 1M

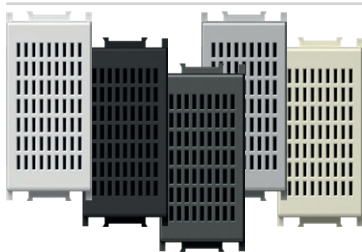

- EM92PW
- EM92MW
- EM92SB
- EM92AT
- EM92ES
- EM92IW

- signálny zvonček
- dĺžka zvukového signálu je rovnaká ako dĺžka stlačenia tlačidla
- napájacie napätie 230 V~ 50 Hz 8 VA

BELL 8VA 230V~1M

- signal bell
- the sound emission has the same lasting time as the control operation
- supply voltage 230V~ 50Hz 8VA



ZVONČEK 8 VA 12V ~ 1M

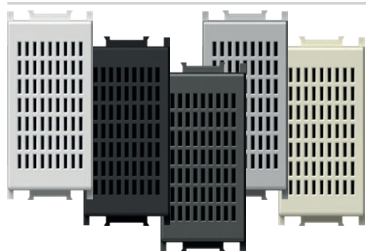

- EM93PW
- EM93MW
- EM93SB
- EM93AT
- EM93ES
- EM93IW

- signálny zvonček
- dĺžka zvukového signálu je rovnaká ako dĺžka stlačenia tlačidla
- napájacie napätie 12 V~ 50 Hz 8 VA

BELL 8VA 12V~1M

- signal bell
- the sound emission has the same lasting time as the control operation
- supply voltage 12V~ 50Hz 8VA



ELEKTRONICKÝ ZVONČEK 230V~ 6mA rms 1M

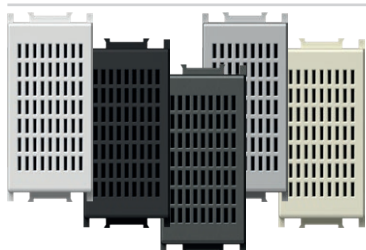

- EM94PW
- EM94MW
- EM94SB
- EM94AT
- EM94ES
- EM94IW

- napájací zdroj 230 V~ 50/60 Hz
- spotreba pri melódii 1; 4,7 mA rms
- spotreba pri melódii 2; 5,9 mA rms
- úroveň zvuku pri melódii 1; 90,5 dB
- úroveň zvuku pri melódii 2; 86 dB
- prevádzková teplota: 0°C/45°C (použitie v interiéri)
- skladovacia teplota: -20°C /50 °C
- trieda ochrany IP: IP20 (iba na použitie v interiéri)
- trieda bezpečnosti zariadenia II
- kategória prepäťovej ochrany (EN 62109): trieda III
- skrutkové upevnenie vodičov max. 2,5 mm²
- kontakty zariadenia s medzerou minimálne 3 mm
- smernice EMC a LVD

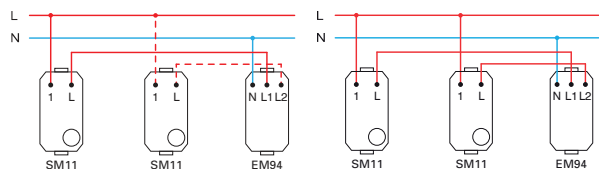
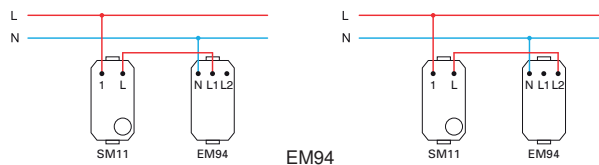

ELECTRONIC BELL 230V~ 6mA rms 1M

- power supply 230 V~ 50/60 Hz
- power consumption when playing melody 1: 4.7 mA rms
- power consumption when playing melody 2: 5.9 mA rms
- sound level of melody 1: 90.5 dB
- sound level of melody 2: 86 dB
- operating temperature 0°C/45°C (indoor use)
- storage temperature: -20°C /50°C
- IP protection class: IP20 (indoor use only)
- class device II
- overvoltage category (EN62109): Class III
- screw contacts: max. 2.5 mm²
- device with a contact gap of at least 3 mm
- an easily accessible cut-off switch must be installed upstream from bell
- complies with EMC & LVD directives

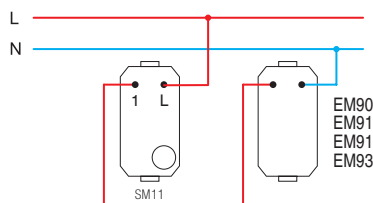
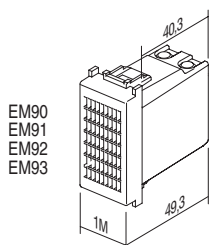

REGULÁTOR HLASITOSTI 100 V 35 W 2M



- EM95PW
- EM95MW
- EM95SB
- EM95AT
- EM95ES
- EM95IW

- regulátor hlasitosti (atenuátor) pre 100 V audio systémy
- menovitý výkon 35 W (max. 45 W), 6-stupňové ovládanie hlasitosti
- vhodný na inštaláciu do hlbokých krabíc (najmenej 60 mm)
- nie je vhodný na inštaláciu do krabíc hlbokých 45 mm a povrchových montážnych krabíc CUBO IP20
- len na použitie v interiéri



VOLUME CONTROL 100V AUDIO LINE 35W 2M

- volume control (attenuator) for 100V audio systems
- power rating 35W (max.45W), 6 steps volume control
- suitable for boxes min. 60 mm deep
- not suitable for installation in 45 mm deep boxes and surface mount boxes CUBO IP20
- for indoor use only

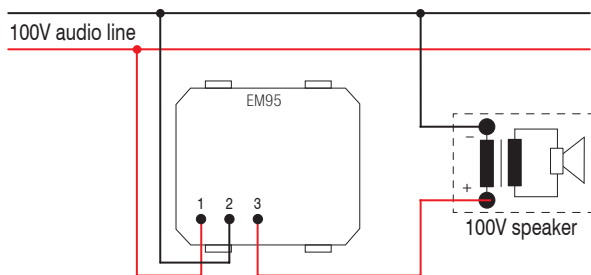

REGULÁTOR HLASITOSTI NÍZKONAPĚŤOVÝ 4-8 Ω 35 W 2M



- EM96PW
- EM96MW
- EM96SB
- EM96AT
- EM96ES
- EM96IW

- regulátor hlasitosti (atenuátor) pre nízkonapäťové výstupy 4 – 8 Ω, 35 W
- menovitý výkon 35 W, 6-stupňové ovládanie hlasitosti
- vhodný na inštaláciu do hlbokých krabíc (najmenej 60 mm)
- nie je vhodný na inštaláciu do krabíc hlbokých 45 mm a povrchových montážnych krabíc CUBO IP20
- len na použitie v interiéri



VOLUME CONTROL 4-8 Ω 35W 2M

- volume control (attenuator) for low voltage outputs 4-8 Ω, 35W
- power rating 35W, 6 steps volume control
- suitable for boxes min. 60 mm deep
- not suitable for installation in 45 mm deep boxes and surface mount boxes CUBO IP20
- for indoor use only

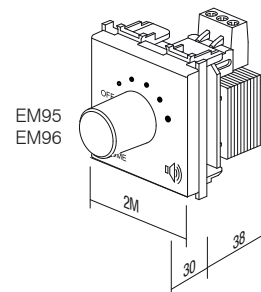
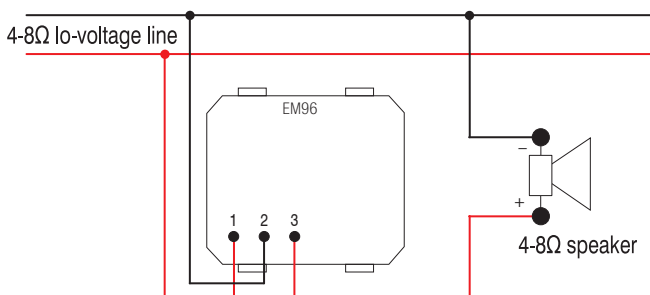

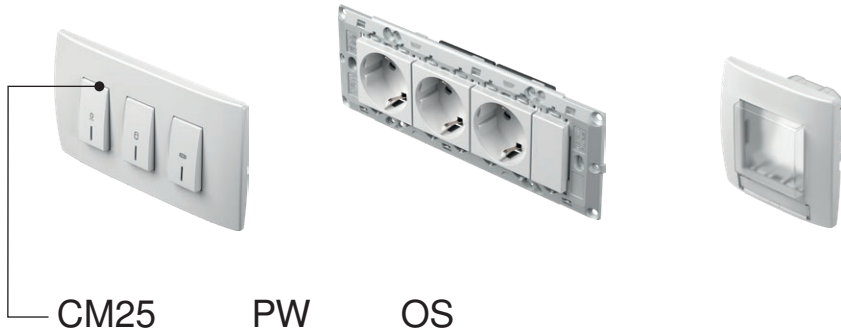

typ type	popis description	technické údaje technical data	veľkosť size	farba colour	voliteľné údaje 1 optional data 1
CM10	SÚPRAVA DVOCH ZÁSUVIEK SCHUKO SOCKET SET 2x SCHUKO	2P+E 16A 250V~	4M	<input type="checkbox"/> PW polárna biela polar white	<input type="checkbox"/> OL rámik LINE cover plate LINE
CM11	SÚPRAVA TROCH ZÁSUVIEK SCHUKO SOCKET SET 3x SCHUKO	2P+E 16A 250V~	7M	<input type="checkbox"/> MW čierna matná zamatová matte white	<input type="checkbox"/> OS rámik SOFT cover plate SOFT
CM15	SÚPRAVA SPOJOVACÍCH KÁBLOV LINK WIRE SET	3x1.5mm ²	1M	<input checked="" type="checkbox"/> SB antracit soft touch black	
⋮	⋮	⋮	⋮	<input checked="" type="checkbox"/> AT strieborná matná anthracite	
⋮	⋮	⋮	⋮	<input type="checkbox"/> ES slonová kosť elox silver	
⋮	⋮	⋮	⋮	<input type="checkbox"/> IW ivory white	

SADA ZÁSUVIEK 2x SCHUKO 2P+E 16A 250V~ 4M

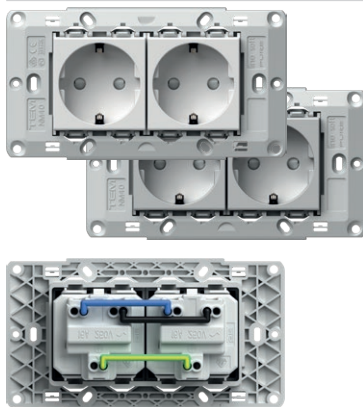

- CM10PW
- CM10ES

- súprava dvoch zásuviek schuko VM10 2P+E 16 A 250 V ~
- s namontovanou kabelážou CM16
- s montážnym rámom 4M bez skrutiek
- na upevnenie k montážnemu rámu použite skrutky CM17, CM18 alebo CM19
- skrutkové upevnenie vodičov 1,5 – 2,5 mm²
- v súlade s normou IEC-60884-1, CEE7

SOCKETS SET 2x SCHUKO 2P+E 16A 250V~ 4M

- socket set 2x schuko VM10 2P+E 16A 250V~
- prewired with link wires CM16
- with mounting frame 4M without screws
- for mounting frame fixing use screws CM17, CM18 or CM19
- screw contacts 1.5-2.5 mm²
- in accordance with IEC-60884-1, CEE7

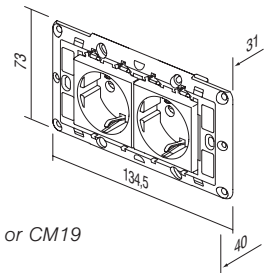

SADA ZÁSUVIEK 3x SCHUKO 2P+E 16A 250V~ 7M

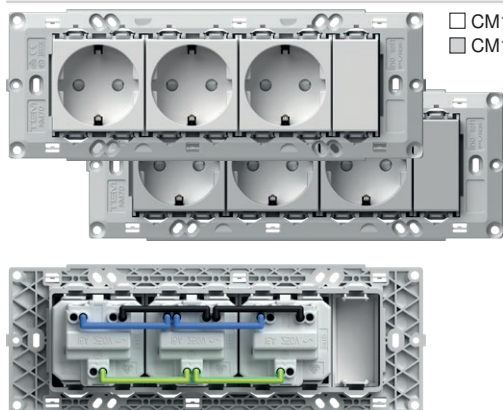

- CM11PW
- CM11ES

- súprava troch zásuviek schuko VM10 2P+E 16 A 250 V ~
- s namontovanou kabelážou CM16
- s montážnym rámom 7M bez skrutiek
- na upevnenie k montážnemu rámu použite skrutky CM17, CM18 alebo CM19
- skrutkové upevnenie vodičov 1,5 – 2,5 mm²
- v súlade s normou IEC-60884-1, CEE7

SOCKETS SET 3x SCHUKO 2P+E 16A 250V~ 7M

- socket set 3x schuko VM10 2P+E 16A 250V~
- prewired with link wires CM16
- with mounting frame 7M without screws
- for mounting frame fixing use screws CM17, CM18 or CM19
- screw contacts 1.5-2.5 mm²
- in accordance with IEC-60884-1, CEE7

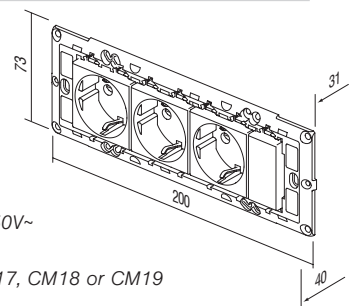

SÚPRAVA PREPOJOVACÍCH PRVKOV 3 x 1,5 mm² 1M

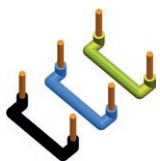

CM15

- súprava spojovacích káblov na pripojenie dvoch prvkov o veľkosti 1M
- zahŕňa 10 čiernych, 10 modrých a 10 žltozelených drôtikov

LINK WIRE SET 3x1.5mm² 1M

- link wire set to connect two elements size 1M
- includes 10 black, 10 blue and 10 yellow/green wires

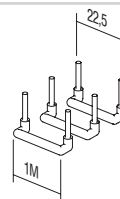

SÚPRAVA PREPOJOVACÍCH PRVKOV 3 x 2,5 mm² 2M

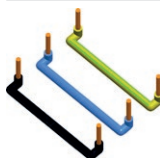

CM16

- súprava spojovacích káblov na pripojenie dvoch prvkov o veľkosti 2M
- zahŕňa 10 čiernych, 10 modrých a 10 žltozelených drôtikov

LINK WIRE SET 3x2.5mm² 2M

- link wire set to connect two elements size 2M
- includes 10 black, 10 blue and 10 yellow/green wires

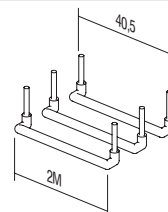

SÚPRAVA SKRUTIEK 3,5

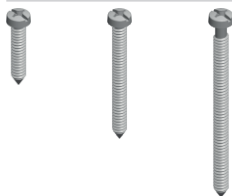

CM17

CM18

CM19

- súprava skrutiek na upevnenie montážnych rámov
NM30, NM32, NM40, NM41, NM70
- CM17 - l = 20 mm, 100 ks
- CM18 - l = 35mm, 50 ks
- CM19 - l = 50 mm, 50 ks

SCREW SET 3,5

- screw set for fixing mounting frames NM30, NM32, NM40, NM41, NM70
- CM17 - l=20mm, 100pcs
- CM18 - l=35mm, 50pcs
- CM19 - l=50mm, 50pcs

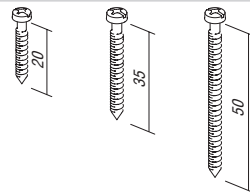

SADA IP 44 PRE SPÍNAČE S POPISNÝM ŠTÍTKOM 2M



- CM22PW
- CM22MW
- CM22SB
- CM22AT
- CM22ES
- CM22IW

- na použitie vo vlhkých priestoroch
- zabezpečuje krytie IP44 vhodné pre všetky spínače radu MODUL
- spínače a kryty tlačidiel nie sú súčasťou súpravy
- rámik SOFT 2M s popisným štítkom
- v súlade s normou IEC 60669-1

SET SWITCHES WITH INSCRIPTION PLATE IP44 2M

- for usage in humid areas
- IP44 protection provides for all Modul switches
- switches and buttons are not part of the set
- include SOFT 2M cover plate with inscription plate and mounting fame
- in accordance with IEC 60669-1



SADA IP44 PRE ZÁSUVKY S POPISNÝM ŠTÍTKOM 2M



- CM23PW
- CM23MW
- CM23SB
- CM23AT
- CM23ES
- CM23IW

- na použitie vo vlhkých priestoroch
- krytie IP44 možno dosiahnuť len v kombinácii s krytú zásuvkou (VM11, VM41)
- zásuvky nie sú súčasťou sady
- rámik SOFT 2M s popisným štítkom
- v súlade s normou IEC 60884-1

SET SOCKETS WITH INSCRIPTION PLATE IP44 2M

- for usage in humid areas
- IP44 protection can be achieved only in combination with covered socket (VM11, VM41)
- sockets are not part of the set
- include SOFT 2M cover plate with inscription plate and mounting fame
- in accordance with IEC 60884-1



SÚPRAVA SPÍNAČOV DO KÚPEĽNE 3x20A 250 V ~ 4M

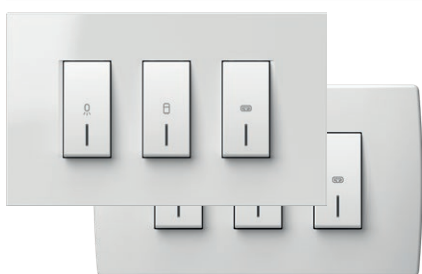

- CM25PWOL
- CM25IWOL
- CM25PWOS
- CM25IWOS

- súprava spínačov 3 x SM12 20 A 250 V ~ s montážnym rámom a dizajnovým rámkom
- skrutkové upevnenie vodičov 1,5 - 2,5 mm²
- v súlade s normou EN 60669-1
- možnosť upevnenia na už nainštalované krabice rozmerov upevnenia od 108 do 135 mm alebo na krabice veľkosti 4M
- výška dekoratívneho rámiča 90 mm

SWITCH SET FOR BATHROOM 3x20A 250V~ 4M

- switch set 3xSM12 20A 250V~ with mounting frame and cover plate
- screw contacts 1.5-2.5mm²
- in accordance with EN 60669-1
- universal solution for renovation on boxes with fixing dimensions 108-135mm or boxes 4M size
- cover plate height 90mm

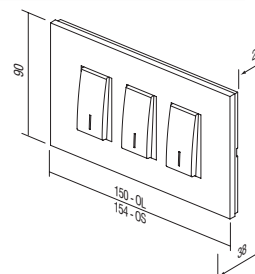



- CM28PW
- CM28MW
- CM28SB
- CM28AT
- CM28ES
- CM28IW

SÚPRAVA PRE SPÍNAČE IP44 2M

- na použitie vo vlhkých oblastiach
- zabezpečuje krytie IP44 vhodné pre všetky spínače Modul
- spínače a tlačidlá nie sú súčasťou súpravy
- rámik SOFT 2M bez popisného štítku
- v súlade s normou 60669-1

SET SWITCHES IP44 2M

- for usage in humid areas
- IP44 protection provides for all Modul switches
- switches and buttons are not part of the set
- SOFT 2M cover plate without inscription plate
- in accordance with IEC 60669-1



- CM29PW
- CM29MW
- CM29SB
- CM29AT
- CM29ES
- CM29IW

SÚPRAVA PRE ZÁSUVKY IP44 2M

- na použitie vo vlhkých oblastiach
- krytie IP44 je možno dosiahnuť len v kombinácii s krytú zásuvkou (VM11, VM41)- zásuvky nie sú súčasťou súpravy
- rámik SOFT 2M bez popisného štítku
- v súlade s normou 60884-1

SET SOCKETS IP44 2M

- for usage in humid areas
- IP44 protection can be achieved only in combination with covered socket (VM11, VM41)
- sockets are not part of the set
- SOFT 2M cover plate without inscription plate
- in accordance with IEC 60884-1

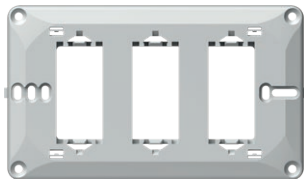

NM41

MONTÁŽNY RÁM PRE KÚPEĽŇOVÉ SADY 4M

- univerzálny montážny rám na kúpeľňové súpravy so skrutkami
- univerzálne riešenie na montáž na obdĺžnikových krabiciach s rozmermi upevnenia 108 – 135 mm alebo na krabiciach o veľkosti 4M
- v súlade s normou EN 60669-1

MOUNTING FRAME BATHROOM SET 4M

- universal mounting frame for bathroom set with screws
- universal solution for mounting on rectangular boxes with fixing dimensions 108-135mm or boxes 4M size
- in accordance with EN 60669-1

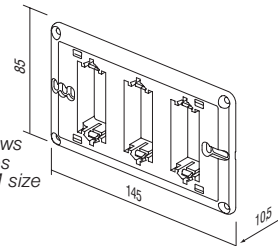

- OL41PW
- OL41MW
- OL41NB
- OL41IW
- OL41ES
- OL41SG
- OL41IB
- OL41AT
- OL41TI
- OL41SB

RÁMIK PRE KÚPEĽŇOVÚ SADU LINE

- dekoratívny rámik pre kúpeľňové súpravy LINE
- výška 90 mm
- v súlade s normou EN 60669-1

COVER PLATE LINE BATHROOM SET

- decorative cover plate bathroom set LINE
- height 90mm
- in accordance with EN 60669-1

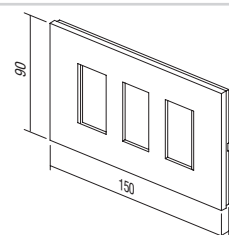

- OS41PW
- OS41MW
- OS41NB
- OS41IW
- OS41ES
- OS41SG
- OS41SB
- OS41WE
- OS41AT
- OS41TI

RÁMIK PRE KÚPEĽŇOVÚ SADU SOFT

- dekoratívny rámik pre kúpeľňové súpravy SOFT
- výška 90 mm
- v súlade s normou EN 60669-1

COVER PLATE SOFT BATHROOM SET

- decorative cover plate bathroom set SOFT
- height 90mm
- in accordance with EN 60669-1

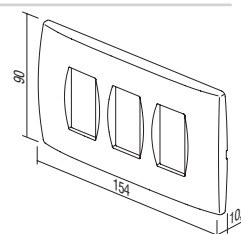

ANTIBAKTERIÁLNY PROGRAM MODUL



typ type	popis description	veľkosť size	farba colour	voliteľné údaje 1 optional data 1
TM11	KRYT TLAČIDLA BUTTON	1M	<input type="checkbox"/> AW antibakteriálna biela antibacterial white	 NT neutrálna neutral
TM21	VÝPLŇ BLANK	1M		
VM10	ZÁSUVKA SOCKET	2M		 IN indikátor indicator
.	.	.		
.	.	.		

ANTIBAKTERIÁLNY PROGRAM MODUL

- spínačov a zásuviek sa denne dotýka mnoho ľudí, takže predstavujú bežné miesto na množenie a šírenie baktérií
- striebro sa vďaka svojim prirodzeným antibakteriálnym vlastnostiam používa tri tisícročia ako bezpečný a účinný dezinfekčný prostriedok, pretože je úplne prírodné, zdravé a šetrné k životnému prostrediu
- špeciálna antibakteriálna prísada iónov striebra poskytuje dlhodobú, spoľahlivú a účinnú ochranu proti vzniku a šíreniu baktérií, mikróbov a plesní
- antibakteriálna ochrana zabezpečuje ľuďom hygienu, čistotu a zdravie
- výborne sa hodí na použitie v prostrediach s prísnymi hygienickými podmienkami (nemocnice, zdravotné strediská, farmaceutické zariadenia, domovy pre seniorov, sanatóriá, laboratória, reštaurácie, hotely, letiská, autobusové a železničné stanice, obchodné a nákupné priestory, verejné inštitúcie...)
- nezávislé laboratórne skúšky boli vykonané v súlade s najprísnejšími japonskými normami JIS Z 2801
- nízke náklady na zabezpečenie verejného zdravia
- dizajn a funkčnosť antibakteriálneho programu MODUL umožňuje jednoduché čistenie a údržbu
- antibakteriálne kryty tlačidiel, rámy a zásuvky sú kombinované s klasickými montážnymi rámmi a spínačmi
- výrobky sú označené na zadnej strane značkou AW (antibakteriálna biela)

ANTIBACTERIAL PROGRAM MODUL

- switches and sockets are daily touched by many people, so this is a common place for development and spread of bacteria
- thanks to its natural antibacterial characteristics silver has been used for three millennia as a safe and effective disinfectant, since it is completely natural, healthy and environmentally friendly
- special antibacterial silver ions additive provides long-term, reliable and effective protection against the development and spread of bacteria, microbes and fungi
- antibacterial protection ensures hygiene, cleanliness and health for people
- perfectly suitable for use in environments with strict hygiene conditions (hospitals, health centers, pharmaceutical facilities, homes for elderly, nursing homes, laboratories, restaurants, hotels, airports, bus and railway stations, business and shopping areas, public institutions ...)
- independent laboratory testings have been carried out in accordance with highest Japanese standards JIS Z 2801
- low cost for providing human health
- design and functionality of antibacterial program MODUL allow easy cleaning and maintenance
- antibacterial buttons, cover plates and sockets are combined with classic mounting frames and switches
- products are labelled on the back with AW (antibacterial white)

A N T I B A C T E R I A L P R O G R A M M O D U L

KRYT TLAČIDLA 1M



□ TM11AW

- vymeniteľný kryt tlačidla 1M
- v súlade s normou EN 60669-1
- antibakteriálna ochrana v súlade s normou JIS Z 2801

BUTTON 1M

- replaceable button 1M
- in accordance with EN 60669-1
- antibacterial protection in accordance with JIS Z 2801



KRYT TLAČIDLA S INDIKÁTOROM 1M



□ TM11AWIN

- vymeniteľný kryt tlačidla s indikátorom 1M
- v súlade s normou EN 60669-1
- antibakteriálna ochrana v súlade s normou JIS Z 2801

BUTTON 1M INDICATOR

- replaceable button 1M
- in accordance with EN 60669-1
- antibacterial protection in accordance with JIS Z 2801



KRYT TLAČIDLA 2M



□ TM12AW

- vymeniteľný kryt tlačidla 2M s úchytkou tlačidla
- pri zmene vypínača alebo tlačidla z 1M na 2M veľkosť
- v súlade s normou EN 60669-1
- antibakteriálna ochrana v súlade s normou JIS Z 2801

BUTTON 2M

- replaceable button 2M with button carrier
- to upgrade switch or push button from size 1M to size 2M
- in accordance with EN 60669-1
- antibacterial protection in accordance with JIS Z 2801



KRYT TLAČIDLA S INDIKÁTOROM 2M



□ TM12AWIN

- vymeniteľný kryt tlačidla s indikátorom 2M s úchytkou tlačidla
- pri zmene vypínača alebo tlačidla z 1M na 2M veľkosť
- v súlade s normou EN 60669-1
- antibakteriálna ochrana v súlade s normou JIS Z 2801

BUTTON 2M INDICATOR

- replaceable button 2M with button carrier
- to upgrade switch or push button from size 1M to size 2M
- in accordance with EN 60669-1
- antibacterial protection in accordance with JIS Z 2801



VÝPLŇ 1M



□ TM21AW

- výplňový modul na zaplnenie prázdnych miest
- v súlade s normou EN 60669-1
- antibakteriálna ochrana v súlade s normou JIS Z 2801

BLANK 1M

- blank modul to fill up empty spaces
- in accordance with EN 60669-1
- antibacterial protection in accordance with JIS Z 2801



VÝPLŇ 2M



□ TM22AW

- výplňový modul na zaplnenie prázdnych miest
- v súlade s normou EN 60669-1
- antibakteriálna ochrana v súlade s normou JIS Z 2801

BLANK 2M

- blank modul to fill up empty spaces
- in accordance with EN 60669-1
- antibacterial protection in accordance with JIS Z 2801





□ VM10AW

ZÁSUVKA SCHUKO + KS 2P+E 16 A 25 0V ~ 2M

- 2P+E schuko
- 16 A 250 V ~, typ VM10
- v súlade s normou IEC 60884-1, CEE7
- skrutkové upevnenie vodičov 1,5 – 2,5 mm²
- zabudovaná ochrana pred dotykom s kontaktní pod napätím
- antibakteriálna ochrana v súlade s normou JIS Z 2801

SOCKET SCHUKO+KS 2P+E 16A 250V~ 2M

- 2P+E schuko
- 16 A 250V~, type VM10
- in accordance with IEC 60884-1, CEE7
- screw contacts 1.5-2.5 mm²
- built-in contact protection
- antibacterial protection in accordance with JIS Z 2801



□ VM11AW

ZÁSUVKA SCHUKO + KS + KRYT 2P+E 16 A 250 V ~ 2M

- 2P + E schuko + kryt
- 16 A 250 V ~, typ VM11
- v súlade s normou IEC 60884-1, CEE7
- skrutkové upevnenie vodičov 1,5 – 2,5 mm²
- zabudovaná ochrana pred dotykom s kontaktní pod napätím
- antibakteriálna ochrana v súlade s normou JIS Z 2801

SOCKET SCHUKO+KS+COVER

- 2P+E 16A 250V~ 2M
- 2P+E schuko+cover
- 16 A 250V~, type VM11
- in accordance with IEC 60884-1, CEE7
- screw contacts 1.5-2.5 mm²
- built-in contact protection
- antibacterial protection in accordance with JIS Z 2801



□ VM20AW

ZÁSUVKA EURO + KS 2P 10 A 250 V ~ 1M

- 2P Euro
- 10 A 250 V ~, typ VM20
- v súlade s normou IEC 60884-1, CEE7
- skrutkové upevnenie vodičov 1,5 – 2,5 mm²
- zabudovaná ochrana pred dotykom s kontaktní pod napätím
- antibakteriálna ochrana v súlade s normou JIS Z 2801

SOCKET EURO+KS 2P 10A 250V~ 1M

- 2P Euro
- 10A 250V~, type VM20
- in accordance with IEC 60884-1, CEE7
- screw contacts 1.5-2.5 mm²
- built-in contact protection
- antibacterial protection in accordance with JIS Z 2801



□ KM11AW

ZÁSUVKA TV KONCOVÁ 1 dB 1M

- TV koncová
- frekvenčné pásmo 5 ÷ 2 400 MHz
- útlm < 1 dB
- v súlade s normou EN 50083-1
- skrutkové upevnenie vodičov
- antibakteriálna ochrana v súlade s normou JIS Z 2801

SOCKET TV END-LINE 1dB 1M

- TV end-line
- frequency range 5÷2400 MHz
- reduction < 1 dB
- in accordance with EN 50083-1
- screw contacts
- antibacterial protection in accordance with JIS Z 2801

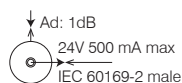

□ KM35AW

ADAPTÉR KS 1M

- KS keystone štandard upevnenia
- AMP, Avaya, Brandrex, FMT, Mfico, Tyco, ...
- komunikačný modul nie je súčasťou dodávky
- antibakteriálna ochrana v súlade s normou JIS Z 2801

ADAPTER KS 1M

- KS keystone fixing standard
- AMP, Avaya, Brandrex, FMT, Mfico, Tyco, ...
- communication module not included
- antibacterial protection in accordance with JIS Z 2801



A N T I B A C T E R I A L P R O G R A M M O D U L



OS20AW

RÁMIK SOFT 2M

- dekoračný rámik SOFT 2M
- v súlade s normou EN 60669-1
- antibakteriálna ochrana v súlade s normou JIS Z 2801

COVER PLATE SOFT 2M

- decorative cover plate SOFT 2M
- in accordance with EN 60669-1
- antibacterial protection in accordance with JIS Z 2801



OS24AW

RÁMIK SOFT 2 x 2M

- dekoračný rámik SOFT 2 x 2M
- horizontálna alebo vertikálna montáž
- v súlade s normou EN 60669-1
- antibakteriálna ochrana v súlade s normou JIS Z 2801

COVER PLATE SOFT 2x2M

- decorative cover plate SOFT 2x2M
- horizontal or vertical mounting
- in accordance with EN 60669-1
- antibacterial protection in accordance with JIS Z 2801



OS26AW

RÁMIK SOFT 3 x 2M

- dekoračný rámik SOFT 3 x 2M
- horizontálna alebo vertikálna montáž
- v súlade s normou EN 60669-1
- antibakteriálna ochrana v súlade s normou JIS Z 2801

COVER PLATE SOFT 3x2M

- decorative cover plate SOFT 3x2M
- horizontal or vertical mounting
- in accordance with EN 60669-1
- antibacterial protection in accordance with JIS Z 2801

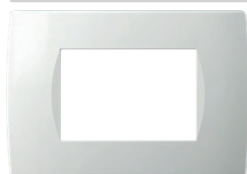

OS30AW

RÁMIK SOFT 3M

- dekoračný rámik SOFT 3M
- antibakteriálna ochrana v súlade s normou JIS Z 2801
- v súlade s normou EN 60669-1

COVER PLATE SOFT 3M

- decorative cover plate SOFT 3M
- in accordance with EN 60669-1
- antibacterial protection in accordance with JIS Z 2801

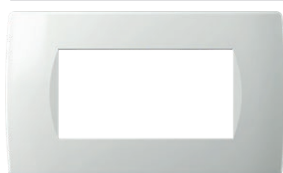

OS40AW

RÁMIK SOFT 4M

- dekoračný rámik SOFT 4M
- v súlade s normou EN 60669-1
- antibakteriálna ochrana v súlade s normou JIS Z 2801

COVER PLATE SOFT 4M

- decorative cover plate SOFT 4M
- in accordance with EN 60669-1
- antibacterial protection in accordance with JIS Z 2801

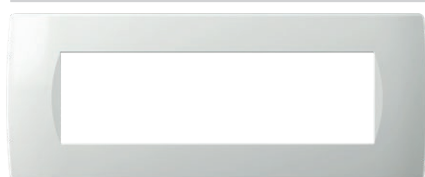

OS70AW

RÁMIK SOFT 7M

- dekoračný rámik SOFT 7M
- v súlade s normou EN 60669-1
- antibakteriálna ochrana v súlade s normou JIS Z 2801

COVER PLATE SOFT 7M

- decorative cover plate SOFT 7M
- in accordance with EN 60669-1
- antibacterial protection in accordance with JIS Z 2801

základná
basic

PW polárna biela
polar white

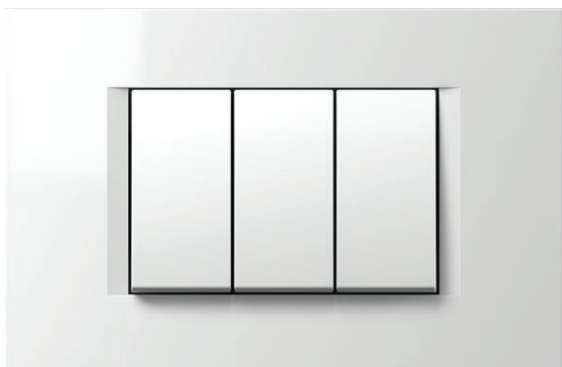

IW slonová kosť
ivory white

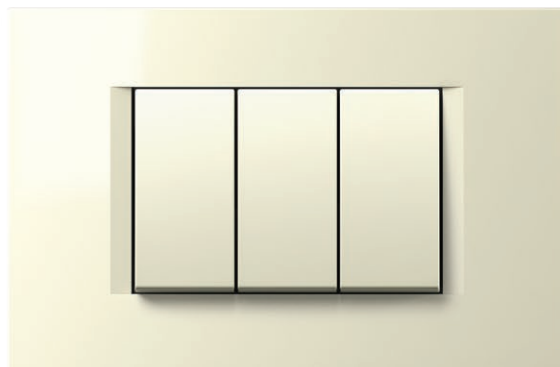

ES strieborná matná
elox silver



SB čierna matná zamatová
soft touch black



AT antracit
anthracite

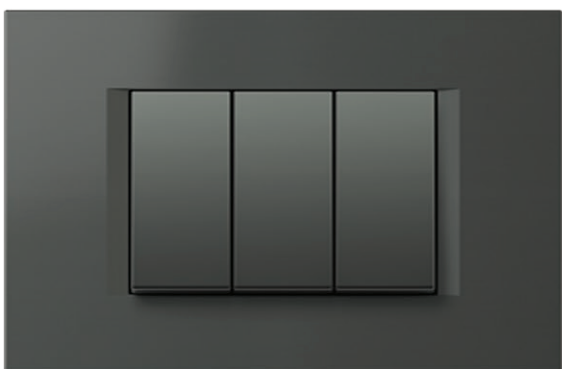

MW biela matná
matte white

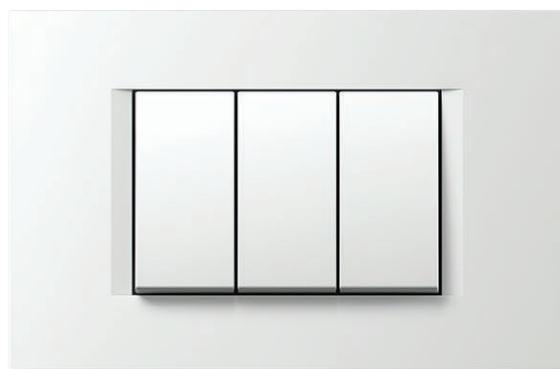

COVER PLATES LINE OL

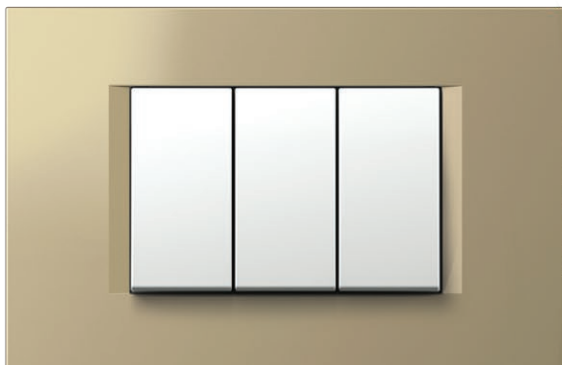
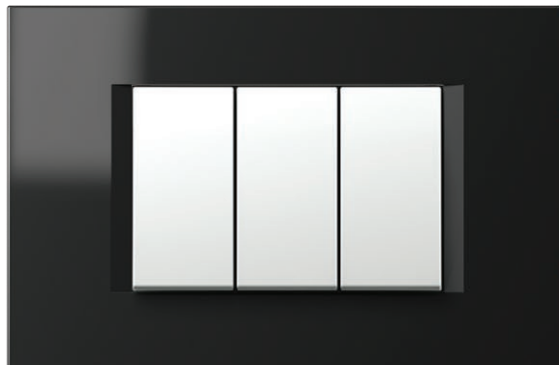
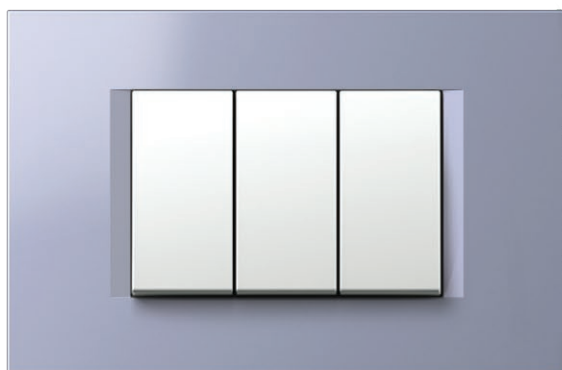
ozdobná
decorSG piesková zlatá
sand goldNB čierna lesklá
night blackIB impulzná modrá
impulse blueTI titán
titaniumSW biela mramor
stone white

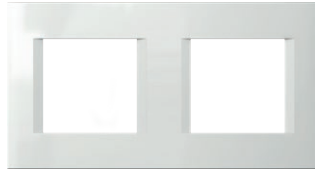

OL30

PW

typ type	popis description	veľkosť size	farba colour																											
OL10	RÁMIK LINE COVER PLATE LINE	1/2M	<table border="0"> <tr> <td></td> <td>PW</td> <td>polárna biela polar white</td> <td></td> <td>SG</td> <td>piesková zlatá sand gold</td> <td></td> <td>AT</td> <td>antracit anthracite</td> </tr> </table>		PW	polárna biela polar white		SG	piesková zlatá sand gold		AT	antracit anthracite																		
	PW	polárna biela polar white		SG	piesková zlatá sand gold		AT	antracit anthracite																						
OL13	RÁMIK LINE COVER PLATE LINE	1/3M	<table border="0"> <tr> <td></td> <td>MW</td> <td>biela matná matte white</td> <td></td> <td>NB</td> <td>čierna lesklá night black</td> <td></td> <td>TI</td> <td>titán titanium</td> </tr> </table>		MW	biela matná matte white		NB	čierna lesklá night black		TI	titán titanium																		
	MW	biela matná matte white		NB	čierna lesklá night black		TI	titán titanium																						
OL20	RÁMIK LINE COVER PLATE LINE	2M	<table border="0"> <tr> <td></td> <td>IW</td> <td>slonová kosť ivory white</td> <td></td> <td>IB</td> <td>impulzná modrá impulse blue</td> <td></td> <td>SW</td> <td>biela mramor stone white</td> </tr> <tr> <td></td> <td>ES</td> <td>strieborná matná elox silver</td> <td></td> <td></td> <td></td> <td></td> <td></td> <td></td> </tr> <tr> <td></td> <td>SB</td> <td>čierna matná zamatová soft touch black</td> <td></td> <td></td> <td></td> <td></td> <td></td> <td></td> </tr> </table>		IW	slonová kosť ivory white		IB	impulzná modrá impulse blue		SW	biela mramor stone white		ES	strieborná matná elox silver								SB	čierna matná zamatová soft touch black						
	IW	slonová kosť ivory white		IB	impulzná modrá impulse blue		SW	biela mramor stone white																						
	ES	strieborná matná elox silver																												
	SB	čierna matná zamatová soft touch black																												



RÁMIK LINE 1/2M



	OL10PW		OL10SG
	OL10MW		OL10NB
	OL10IW		OL10IB
	OL10ES		OL10AT
	OL10SB		OL10TI
			OL10SW

- dekoračný rámik LINE 1/2M
- v súlade s normou EN 60669-1

COVER PLATE LINE 1/2M

- decorative cover plate LINE 1/2M
- in accordance with EN 60669-1

RÁMIK LINE 2M



	OL20PW		OL20SG
	OL20MW		OL20NB
	OL20IW		OL20IB
	OL20ES		OL20AT
	OL20SB		OL20TI
			OL20SW

- dekoračný rámik LINE 2M
- v súlade s normou EN 60669-1

COVER PLATE LINE 2M

- decorative cover plate LINE 2M
- in accordance with EN 60669-1

RÁMIK LINE 2x2M

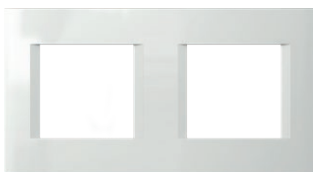

	OL24PW		OL24SG
	OL24MW		OL24NB
	OL24IW		OL24IB
	OL24ES		OL24AT
	OL24SB		OL24TI
			OL24SW

- dekoračný rámik LINE 2 x 2M
- horizontálna alebo vertikálna montáž
- v súlade s normou EN 60669-1

COVER PLATE LINE 2x2M

- decorative cover plate LINE 2x2M
- horizontal or vertical mounting
- in accordance with EN 60669-1

RÁMIK LINE 3x2M

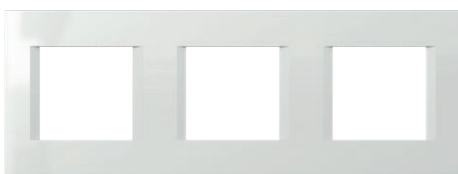

	OL26PW		OL26SG
	OL26MW		OL26NB
	OL26IW		OL26IB
	OL26ES		OL26AT
	OL26SB		OL26TI
			OL26SW

- dekoračný rámik LINE 3 x 2M
- horizontálna alebo vertikálna montáž
- v súlade s normou EN 60669-1

COVER PLATE LINE 3x2M

- decorative cover plate LINE 3x2M
- horizontal or vertical mounting
- in accordance with EN 60669-1

RÁMIK LINE 4x2M



	OL28PW		OL28SG
	OL28MW		OL28NB
	OL28IW		OL28IB
	OL28ES		OL28AT
	OL28SB		OL28TI
			OL28SW

- dekoračný rámik LINE 4 x 2M
- horizontálna alebo vertikálna montáž
- v súlade s normou EN 60669-1

COVER PLATE LINE 4x2M

- decorative cover plate LINE 4x2M
- horizontal or vertical mounting
- in accordance with EN 60669-1

RÁMIK LINE 5x2M

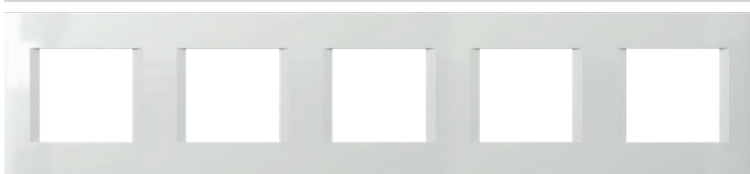

	OL29PW
	OL29MW
	OL29IW
	OL29ES
	OL29SB
	OL29AT
	OL29TI

- dekoračný rámik LINE 5 x 2M
- horizontálna alebo vertikálna montáž
- v súlade s normou EN 60669-1

COVER PLATE LINE 5x2M

- decorative cover plate LINE 5x2M
- horizontal or vertical mounting
- in accordance with EN 60669-1

COVER PLATES LINE OL

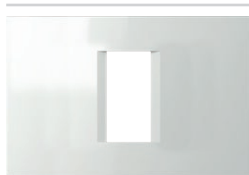

	OL13PW		OL13SG
	OL13MW		OL13NB
	OL13IW		OL13IB
	OL13ES		OL13AT
	OL13SB		OL13TI
			OL13SW

RÁMIK LINE 1/3M

- dekoračný rámik LINE 1/3M
- v súlade s normou EN 60669-1

COVER PLATE LINE 1/3M

- decorative cover plate LINE 1/3M
- in accordance with EN 60669-1

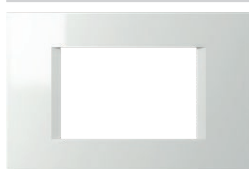

	OL30PW		OL30SG
	OL30MW		OL30NB
	OL30IW		OL30IB
	OL30ES		OL30AT
	OL30SB		OL30TI
			OL30SW

RÁMIK LINE 3M

- dekoračný rámik LINE 3M
- v súlade s normou EN 60669-1

COVER PLATE LINE 3M

- decorative cover plate LINE 3M
- in accordance with EN 60669-1



	OL40PW		OL40SG
	OL40MW		OL40NB
	OL40IW		OL40IB
	OL40ES		OL40AT
	OL40SB		OL40TI
			OL40SW

RÁMIK LINE 4M

- dekoračný rámik LINE 4M
- v súlade s normou EN 60669-1

COVER PLATE LINE 4M

- decorative cover plate LINE 4M
- in accordance with EN 60669-1

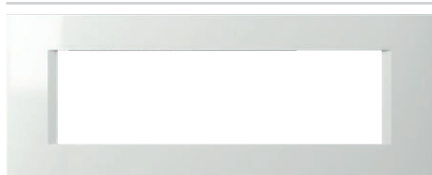

	OL70PW		OL70SG
	OL70MW		OL70NB
	OL70IW		OL70IB
	OL70ES		OL70AT
	OL70SB		OL70TI
			OL70SW

RÁMIK LINE 7M

- dekoračný rámik LINE 7M
- v súlade s normou EN 60669-1

COVER PLATE LINE 7M

- decorative cover plate LINE 7M
- in accordance with EN 60669-1



	OL71PW		OL71AT
	OL71MW		OL71TI
	OL71IW		
	OL71ES		
	OL71SB		

RÁMIK LINE 2x7M

- dekoračný rámik LINE 2x7M
- v súlade s normou EN 60669-1

COVER PLATE LINE 2x7M

- decorative cover plate LINE 2x7M
- in accordance with EN 60669-1

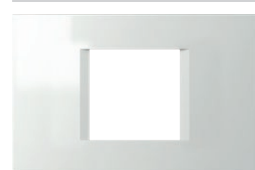

	OL23PW		OL23SG
	OL23MW		OL23NB
	OL23IW		OL23IB
	OL23ES		OL23AT
	OL23SB		OL23TI
			OL23SW

RÁMIK LINE 2/3M

- dekoračný rámik LINE 2/3M
- v súlade s normou EN 60669-1

COVER PLATE LINE 2/3M

- decorative cover plate LINE 2/3M
- in accordance with EN 60669-1

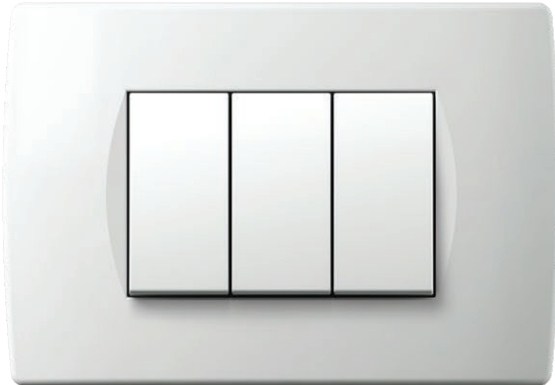
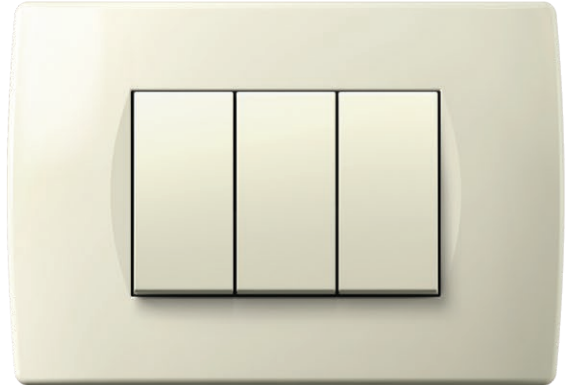
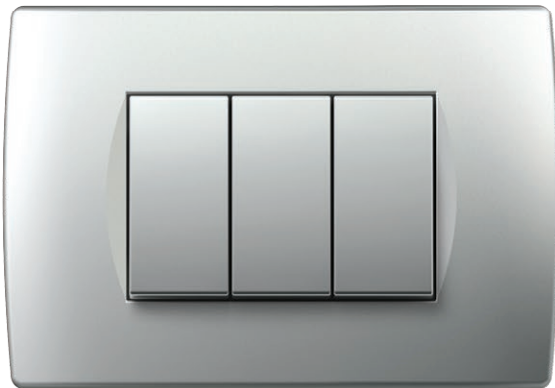
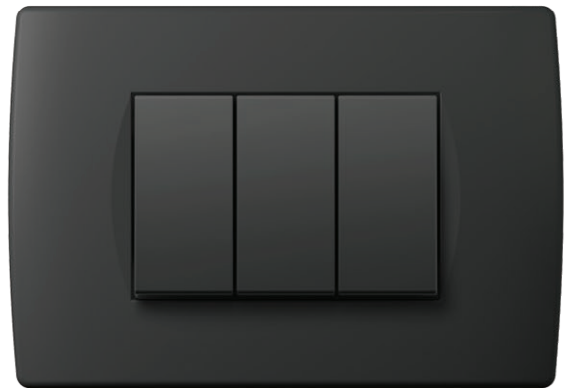
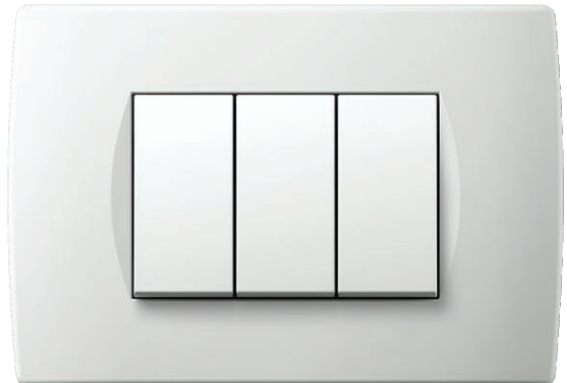
základná
basicPW polárna biela
polar whiteIW slonová kosť
ivory whiteES strieborná matná
elox silverSB čierna matná zamatová
soft touch blackAT antracit
anthraciteMW biela matná
matte white

COVER PLATES S O F T O S

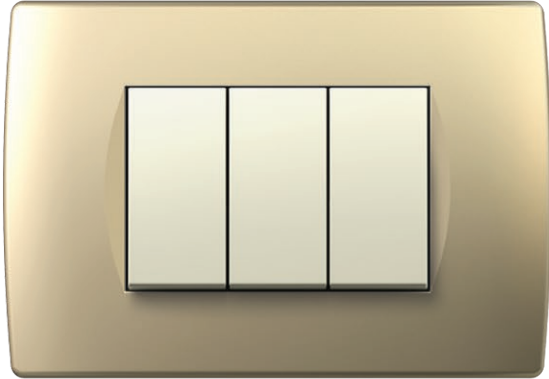
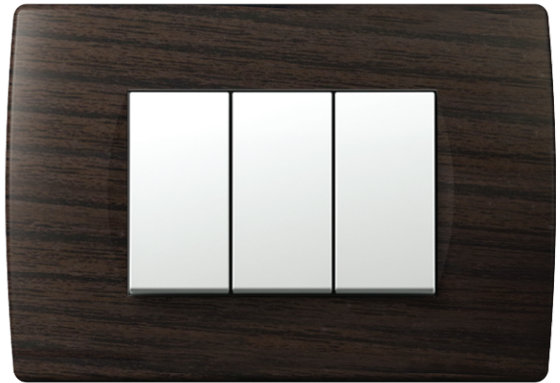
ozdobná
decorSG piesková zlatá
sand goldNB čierna lesklá
night blackTI titán
titaniumWE wenge
wengeWW orech
walnut



OS30



PW

typ type	popis description	veľkosť size	farba colour																														
OS10	RÁMIK SOFT COVER PLATE SOFT	1/2M	<table border="0"> <tr> <td></td> <td>PW polárna biela polar white</td> <td></td> <td>SG piesková zlatá sand gold</td> <td></td> <td>WW orech walnut</td> </tr> <tr> <td></td> <td>MW biela matná matte white</td> <td></td> <td>NB čierna lesklá night black</td> <td></td> <td>WE wenge wenge</td> </tr> <tr> <td></td> <td>IW slonová kost ivory white</td> <td></td> <td>AT antracit anthracite</td> <td></td> <td>TI titán titanium</td> </tr> <tr> <td></td> <td>ES strieborná matná elox silver</td> <td></td> <td>TI titán titanium</td> <td></td> <td></td> </tr> <tr> <td></td> <td>SB čierna matná soft touch black</td> <td></td> <td></td> <td></td> <td></td> </tr> </table>		PW polárna biela polar white		SG piesková zlatá sand gold		WW orech walnut		MW biela matná matte white		NB čierna lesklá night black		WE wenge wenge		IW slonová kost ivory white		AT antracit anthracite		TI titán titanium		ES strieborná matná elox silver		TI titán titanium				SB čierna matná soft touch black				
	PW polárna biela polar white		SG piesková zlatá sand gold		WW orech walnut																												
	MW biela matná matte white		NB čierna lesklá night black		WE wenge wenge																												
	IW slonová kost ivory white		AT antracit anthracite		TI titán titanium																												
	ES strieborná matná elox silver		TI titán titanium																														
	SB čierna matná soft touch black																																
OS13	RÁMIK SOFT COVER PLATE SOFT	1/3M																															
OS20	RÁMIK SOFT COVER PLATE SOFT	2M																															
.	.	.																															
.	.	.																															



	OS10PW		OS10SG
	OS10MW		OS10NB
	OS10IW		OS10AT
	OS10ES		OS10TI
	OS10SB		OS10WW
			OS10WE

RÁMIK SOFT 1/2M

- dekoračný rámik SOFT 1/2M
- v súlade s normou EN 60669-1

COVER PLATE SOFT 1/2M

- decorative cover plate SOFT 1/2M
- in accordance with EN 60669-1



	OS20PW		OS20SG
	OS20MW		OS20NB
	OS20IW		OS20AT
	OS20ES		OS20TI
	OS20SB		OS20WW
			OS20WE

RÁMIK SOFT 2M

- dekoračný rámik SOFT 2M
- v súlade s normou EN 60669-1

COVER PLATE SOFT 2M

- decorative cover plate SOFT 2M
- in accordance with EN 60669-1



	OS24PW		OS24SG
	OS24MW		OS24NB
	OS24IW		OS24AT
	OS24ES		OS24TI
	OS24SB		OS24WW
			OS24WE

RÁMIK SOFT 2 x 2M

- dekoračný rámik SOFT 2 x 2M
- horizontálna alebo vertikálna montáž
- v súlade s normou EN 60669-1

COVER PLATE SOFT 2x2M

- decorative cover plate SOFT 2x2M
- horizontal or vertical mounting
- in accordance with EN 60669-1



	OS26PW		OS26SG
	OS26MW		OS26NB
	OS26IW		OS26AT
	OS26ES		OS26TI
	OS26SB		OS26WW
			OS26WE

RÁMIK SOFT 3 x 2M

- dekoračný rámik
SOFT 3 x 2M
- horizontálna alebo vertikálna montáž
- v súlade s normou EN 60669-1

COVER PLATE SOFT 3x2M

- decorative cover plate
SOFT 3x2M
- horizontal or vertical mounting
- in accordance with EN 60669-1



	OS28PW		OS28SG
	OS28MW		OS28NB
	OS28IW		OS28AT
	OS28ES		OS28TI
	OS28SB		OS28WW
			OS28WE

RÁMIK SOFT 4 x 2M

- dekoračný rámik
SOFT 4 x 2M
- horizontálna alebo vertikálna montáž
- v súlade s normou EN 60669-1

COVER PLATE SOFT 4x2M

- decorative cover plate
SOFT 4x2M
- horizontal or vertical mounting
- in accordance with EN 60669-1

COVER PLATES SOFT OS

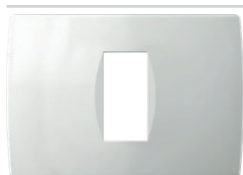

	OS13PW		OS13SG
	OS13MW		OS13NB
	OS13IW		OS13AT
	OS13ES		OS13TI
	OS13SB		OS13WW
			OS13WE

RÁMIK SOFT 1/3M

- dekoračný rámik SOFT 1/3M
- v súlade s normou EN 60669-1

COVER PLATE SOFT 1/3M

- decorative cover plate SOFT 1/3M
- in accordance with EN 60669-1

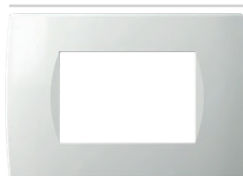

	OS30PW		OS30SG
	OS30MW		OS30NB
	OS30IW		OS30AT
	OS30ES		OS30TI
	OS30SB		OS30WW
			OS30WE

RÁMIK SOFT 3M

- dekoračný rámik SOFT 3M
- v súlade s normou EN 60669-1

COVER PLATE SOFT 3M

- decorative cover plate SOFT 3M
- in accordance with EN 60669-1



	OS40PW		OS40SG
	OS40MW		OS40NB
	OS40IW		OS40AT
	OS40ES		OS40TI
	OS40SB		OS40WW
			OS40WE

RÁMIK SOFT 4M

- dekoračný rámik SOFT 4M
- v súlade s normou EN 60669-1

COVER PLATE SOFT 4M

- decorative cover plate SOFT 4M
- in accordance with EN 60669-1



	OS70PW		OS70SG
	OS70MW		OS70NB
	OS70IW		OS70AT
	OS70ES		OS70TI
	OS70SB		OS70WW
			OS70WE

RÁMIK SOFT 7M

- dekoračný rámik SOFT 7M
- v súlade s normou EN 60669-1

COVER PLATE SOFT 7M

- decorative cover plate SOFT 7M
- in accordance with EN 60669-1



	OS71PW		OS71AT
	OS71MW		OS71TI
	OS71IW		
	OS71ES		
	OS71SB		

RÁMIK SOFT 2x7M

- dekoračný rámik SOFT 2 x 7M
- v súlade s normou EN 60669-1

COVER PLATE SOFT 2x7M

- decorative cover plate SOFT 2x7M
- in accordance with EN 60669-1



	OS72PW		OS72SG
	OS72IW		OS72AT
	OS72ES		OS72TI
	OS72SB		

RÁMIK SOFT 2x7M

- dekoračný rámik SOFT 2 x 7M
s popisnou tabuľou
- v súlade s normou EN 60669-1

COVER PLATE SOFT 2x7M

- decorative cover plate SOFT 2x7M
with inscription plate
- in accordance with EN 60669-1

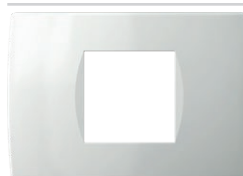

	OS23PW		OS23SG
	OS23MW		OS23NB
	OS23IW		OS23AT
	OS23ES		OS23TI
	OS23SB		OS23WW
			OS23WE

RÁMIK SOFT 2/3M

- dekoračný rámik SOFT 2/3M
- v súlade s normou EN 60669-1

COVER PLATE SOFT 2/3M

- decorative cover plate SOFT 2/3M
- in accordance with EN 60669-1

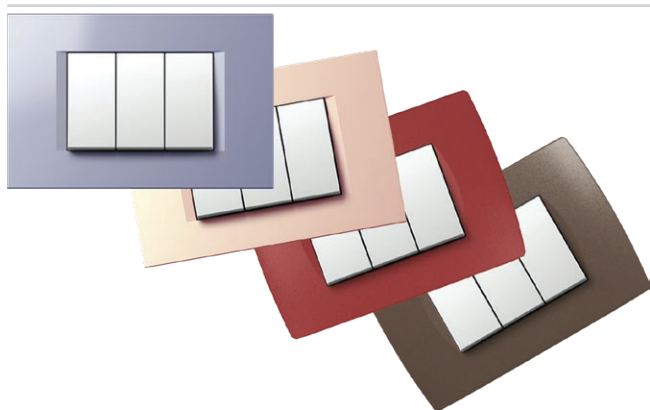

DEKORÁCIE RÁMIKOV

- pri objednávke veľkého množstva je možné rámičky vyrobiť vo farbe podľa vášho výberu
- vhodné pre rámičky OL, OS

COVER PLATES DECORATIONS

- when ordering large quantities, cover plates can be made in the colour of your choice
- suitable for cover plates OL, OS

drevo
woodWB bambus
bambooWW orech
walnutWM javor
mapleWE wenge
wenge

Priroda je jedinečná a vzácna, rovnako ako naše dekoratívne (krycie) rámy, z ktorých ani jeden nie je rovnaký ako druhý.
Sťažnosti na rozdielny vzhľad a odlišnosť našich drevených dekoratívnych (krycích) rámov nemôžeme brať do úvahy.

Nature is unique and precious, as our decorative cover plates where no two are the same.
Complaints about wooden decorative cover plate's diverse appearance and differentiation cannot be considered.

MODUL

PURE

C O V E R P L A T E S P U R E O P

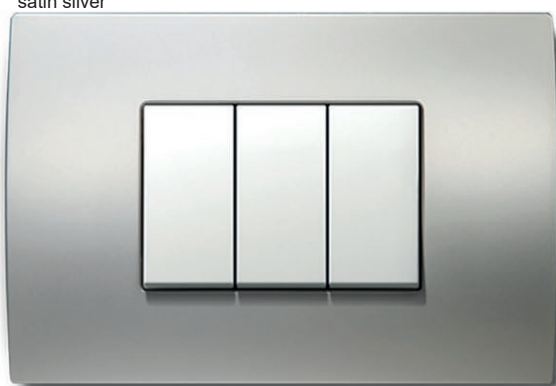
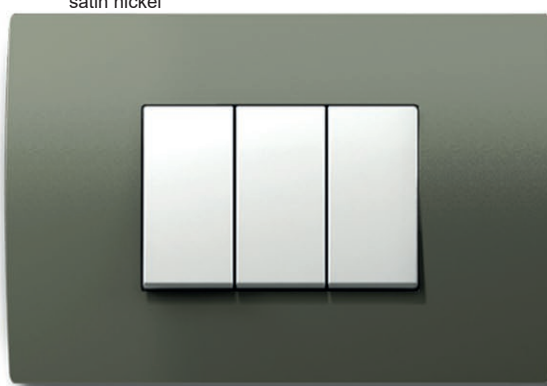
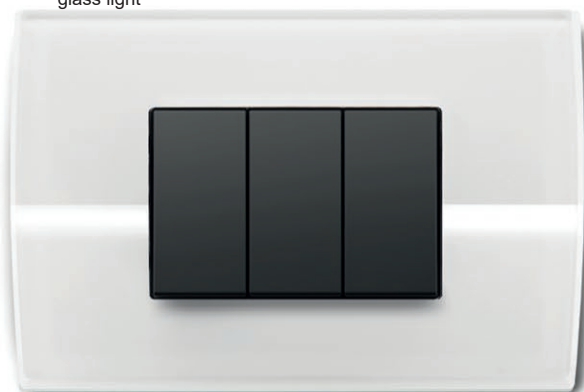
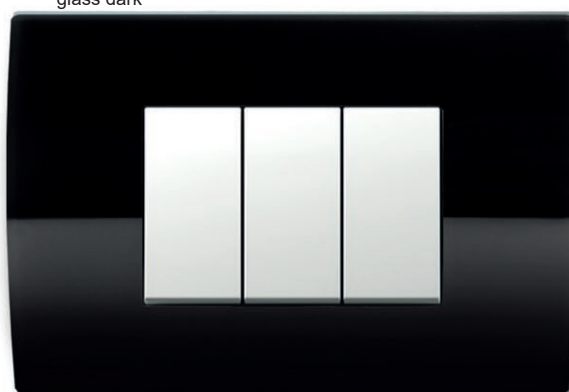
kov
metalMH kovaná oceľ
hammered steelME zoxidované železo
etched ironMS satinované striebro
satin silverMN satinovaný nikel
satin nickelsklo
glassGL biela
glass lightGD čierna
glass dark

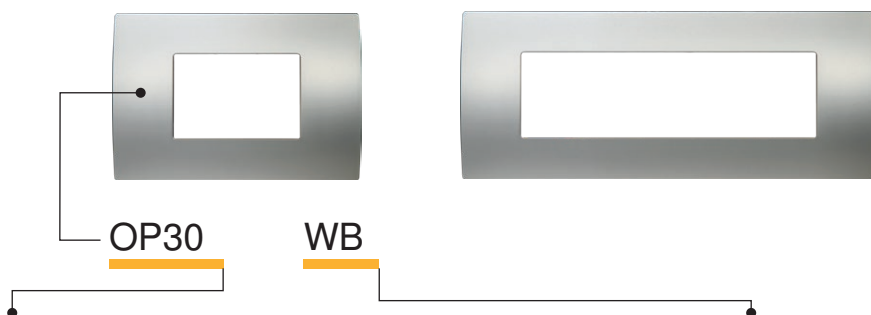

typ type	popis description	veľkosť size	farba colour
OP13	RÁMIK PURE COVER PLATE PURE	1/3M	MH kovaná oceľ hammered steel
OP20	RÁMIK PURE COVER PLATE PURE	2M	ME zoxidované železo etched iron
OP23	RÁMIK PURE COVER PLATE PURE	2/3M	MS satínované striebro satin silver
.	.	.	MN satínovaný nikel satin nickel
.	.	.	WB bambus bamboo
.	.	.	WW orech walnut
.	.	.	WM javor maple
.	.	.	WE wenge wenge
.	.	.	GL biela glass light
.	.	.	GD čierna glass dark



MH	OP20MH	WB	OP20WB
ME	OP20ME	WW	OP20WW
MS	OP20MS	WM	OP20WM
MN	OP20MN	WE	OP20WE
		GL	OP20GL
		GD	OP20GD

RÁMIK PURE 2M

- dekoratívny rámik PURE 2M
- v súlade s normou EN 60669-1
- len v kombinácii s montážnym rámom NM24 alebo NM25

COVER PLATE PURE 2M

- decorative cover plate PURE 2M
- in accordance with EN 60669-1



MH	OP24MH	WB	OP24WB
ME	OP24ME	WW	OP24WW
MS	OP24MS	WM	OP24WM
MN	OP24MN	WE	OP24WE
		GL	OP24GL
		GD	OP24GD

RÁMIK PURE 2x2M

- dekoratívny rámik PURE 2x2M
- horizontálna alebo vertikálna montáž
- v súlade s normou EN 60669-1
- len v kombinácii s montážnym rámom NM24 alebo NM25

COVER PLATE PURE 2x2M

- decorative cover plate PURE 2x2M
- horizontal or vertical mounting
- in accordance with EN 60669-1

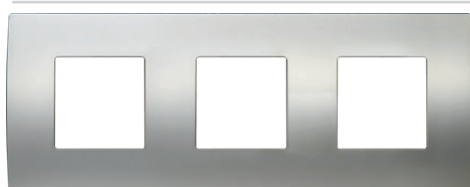

MH	OP26MH	WB	OP26WB
ME	OP26ME	WW	OP26WW
MS	OP26MS	WM	OP26WM
MN	OP26MN	WE	OP26WE
		GL	OP26GL
		GD	OP26GD

RÁMIK PURE 3x2M

- dekoratívny rámik PURE 3x2M
- horizontálna alebo vertikálna montáž
- v súlade s normou EN 60669-1
- len v kombinácii s montážnym rámom NM24 alebo NM25

COVER PLATE PURE 3x2M

- decorative cover plate PURE 3x2M
- horizontal or vertical mounting
- in accordance with EN 60669-1



MH	OP28MH	WB	OP28WB
ME	OP28ME	WW	OP28WW
MS	OP28MS	WM	OP28WM
MN	OP28MN	WE	OP28WE
		GL	OP28GL
		GD	OP28GD

RÁMIK PURE 4x2M

- dekoratívny rámik PURE 4x2M
- horizontálna alebo vertikálna montáž
- v súlade s normou EN 60669-1
- len v kombinácii s montážnym rámom NM24 alebo NM25

COVER PLATE PURE 4x2M

- decorative cover plate PURE 4x2M
- horizontal or vertical mounting
- in accordance with EN 60669-1

COVER PLATES PURE OP

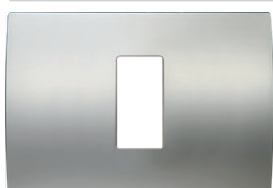

	OP13MH		OP13WB
	OP13ME		OP13WW
	OP13MS		OP13WM
	OP13MN		OP13WE
			OP13GL
			OP13GD

RÁMIK PURE 1/3M

- dekoračný rámik PURE 1/3M
- v súlade s normou EN 60669-1

COVER PLATE PURE 1/3M

- decorative cover plate PURE 1/3M
- in accordance with EN 60669-1

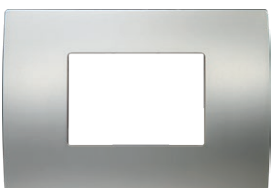

	OP30MH		OP30WB
	OP30ME		OP30WW
	OP30MS		OP30WM
	OP30MN		OP30WE
			OP30GL
			OP30GD

RÁMIK PURE 3M

- dekoračný rámik PURE 3M
- v súlade s normou EN 60669-1

COVER PLATE PURE 3M

- decorative cover plate PURE 3M
- in accordance with EN 60669-1

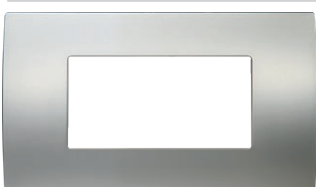

	OP40MH		OP40WB
	OP40ME		OP40WW
	OP40MS		OP40WM
	OP40MN		OP40WE
			OP40GL
			OP40GD

RÁMIK PURE 4M

- dekoračný rámik PURE 4M
- v súlade s normou EN 60669-1

COVER PLATE PURE 4M

- decorative cover plate PURE 4M
- in accordance with EN 60669-1

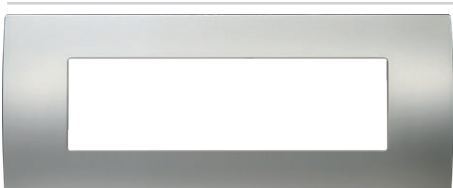

	OP70MH		OP70WB
	OP70ME		OP70WW
	OP70MS		OP70WM
	OP70MN		OP70WE
			OP70GL
			OP70GD

RÁMIK PURE 7M

- dekoračný rámik PURE 7M
- v súlade s normou EN 60669-1

COVER PLATE PURE 7M

- decorative cover plate PURE 7M
- in accordance with EN 60669-1

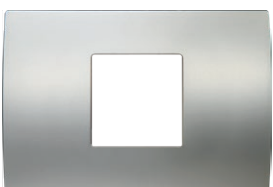

	OP23MH		OP23WB
	OP23ME		OP23WW
	OP23MS		OP23WM
	OP23MN		OP23WE
			OP23GL
			OP23GD

RÁMIK PURE 2/3M

- dekoračný rámik PURE 2/3M
- v súlade s normou EN 60669-1

COVER PLATE PURE 2/3M

- decorative cover plate PURE 2/3M
- in accordance with EN 60669-1

Be bold, be EDGE

C O V E R P L A T E S E D G E O G

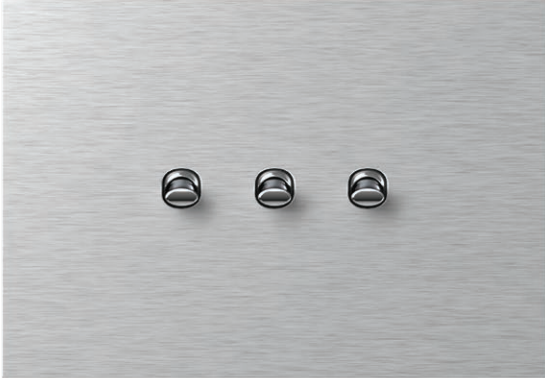
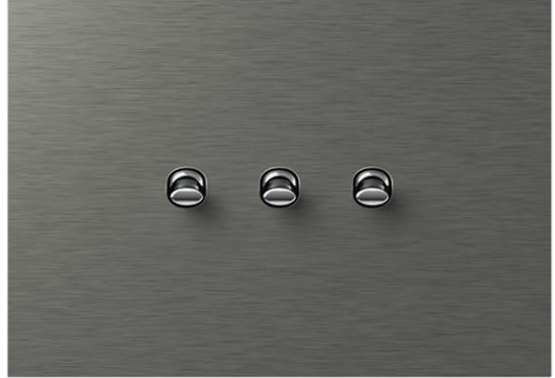
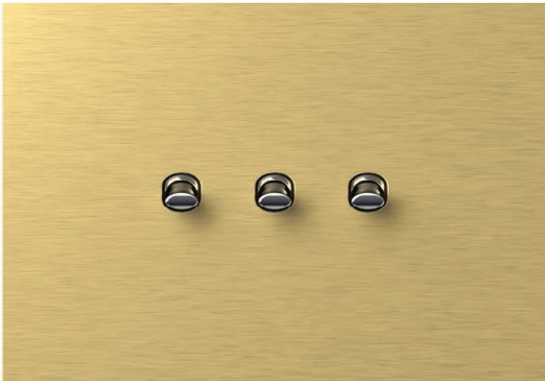
kov
metalMA strieborná
silverMT antracitová
anthraciteMZ zlatá
goldsklo
glassGD čierna
glass darkGL biela
glass light



typ type	názov description	veľkosť size	farba colour
OG10	RÁMIK EDGE COVER PLATE EDGE	1/2M	MA strieborná silver
OG13	RÁMIK EDGE COVER PLATE EDGE	1/3M	MT antracitová anthracite
OG20	RÁMIK EDGE COVER PLATE EDGE	2M	MZ zlatá gold
...	GD čierna glass dark
...	GL biela glass light

P

M

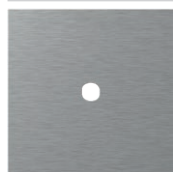

OG10MAP OG10GDP
OG10MTP OG10GLP
OG10MZP

RÁMIK EDGE 1/2M

- dekoratívny rámik EDGE 1/2M
- v súlade s normou EN 60669-1

COVER PLATE EDGE 1/2M

- decorative cover plate EDGE 1/2M
- in accordance with EN 60669-1

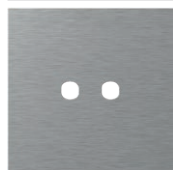

OG20MAP OG20GDP
OG20MTP OG20GLP
OG20MZP

RÁMIK EDGE 2M

- dekoratívny rámik EDGE 2M
- v súlade s normou EN 60669-1

COVER PLATE EDGE 2M

- decorative cover plate EDGE 2M
- in accordance with EN 60669-1

C O V E R P L A T E S E D G E O G

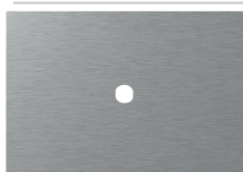

 OG13MAP	 OG13GDP
 OG13MTP	 OG13GLP
 OG13MZP	

RÁMIK EDGE 1/3M

- dekoratívny rámik EDGE 1/3M
- v súlade s normou EN 60669-1

COVER PLATE EDGE 1/3M

- decorative cover plate EDGE 1/3M
- in accordance with EN 60669-1

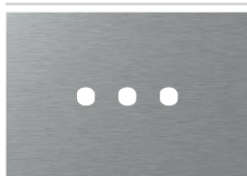

 OG30MAP	 OG30GDP
 OG30MTP	 OG30GLP
 OG30MZP	

RÁMIK EDGE 3M

- dekoratívny rámik EDGE 3M
- v súlade s normou EN 60669-1

COVER PLATE EDGE 3M

- decorative cover plate EDGE 3M
- in accordance with EN 60669-1

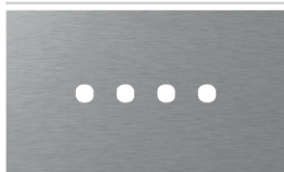

 OG40MAP	 OG40GDP
 OG40MTP	 OG40GLP
 OG40MZP	

RÁMIK EDGE 4M

- dekoratívny rámik EDGE 4M
- v súlade s normou EN 60669-1

COVER PLATE EDGE 4M

- decorative cover plate EDGE 4M
- in accordance with EN 60669-1

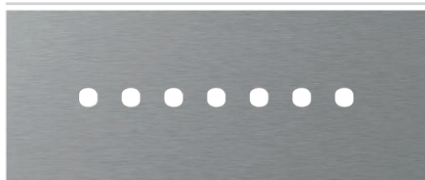

 OG70MAP	 OG70GDP
 OG70MTP	 OG70GLP
 OG70MZP	

RÁMIK EDGE 7M

- dekoratívny rámik EDGE 7M
- v súlade s normou EN 60669-1

COVER PLATE EDGE 7M

- decorative cover plate EDGE 7M
- in accordance with EN 60669-1

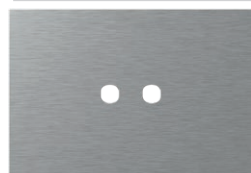

 OG23MAP	 OG23GDP
 OG23MTP	 OG23GLP
 OG23MZP	

RÁMIK EDGE 2/3M

- dekoratívny rámik EDGE 2/3M
- v súlade s normou EN 60669-1

OKVIR EDGE 2/3M

- dekoratívni okvir EDGE 2/3M
- uskladen s normom EN 60669-1

kov
metal

MA strieborná
silver

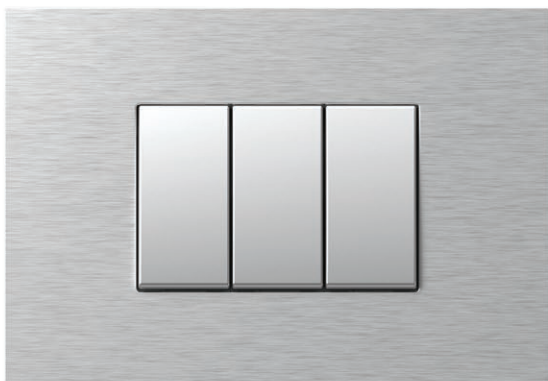

MT antracitová
anthracite



MZ zlatá
gold

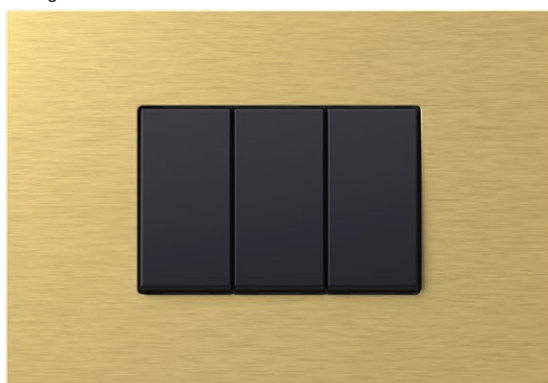

sklo
glass

GD čierna
glass dark

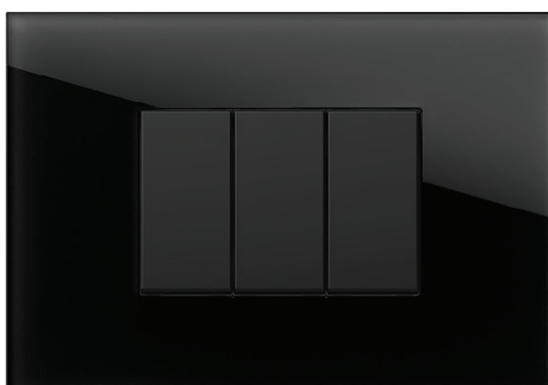

GL biela
glas light

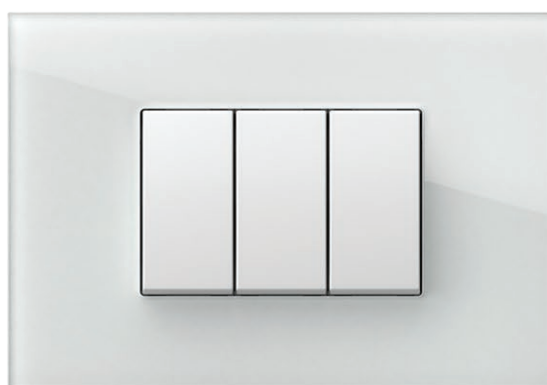

COVER PLATES EDGE OG



OG30

MA

M

typ type	názov description	veľkosť size	farba colour
OG10	RÁMIK EDGE COVER PLATE EDGE	1/2M	MA strieborná silver
OG13	RÁMIK EDGE COVER PLATE EDGE	1/3M	MT antracitová anthracite
OG20	RÁMIK EDGE COVER PLATE EDGE	2M	MZ zlatá gold
...

GD čierna
glass darkGL biela
glass light

M

P

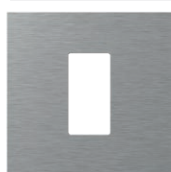
OG10MAM
OG10MTM
OG10MZMOG10GDM
OG10GLM

RÁMIK EDGE 1/2M

- dekoratívny rámik EDGE 1/2M
- v súlade s normou EN 60669-1

COVER PLATE EDGE 1/2M

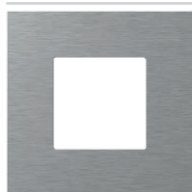
- decorative cover plate EDGE 1/2M
- in accordance with EN 60669-1OG20MAM
OG20MTM
OG20MZMOG20GDM
OG20GLM

RÁMIK EDGE 2M

- dekoratívny rámik EDGE 2M
- v súlade s normou EN 60669-1

COVER PLATE EDGE 2M

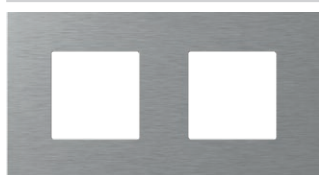
- decorative cover plate EDGE 2M
- in accordance with EN 60669-1OG24MAM
OG24MTM
OG24MZMOG24GDM
OG24GLM

RÁMIK EDGE 2x2M

- dekoratívny rámik EDGE 2x2M
- horizontálna alebo vertikálna inštalácia
- v súlade s normou EN 60669-1

COVER PLATE EDGE 2x2M

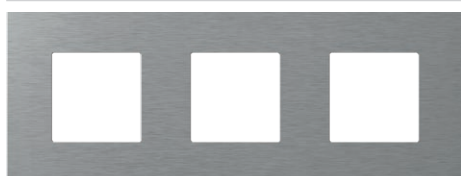
- decorative cover plate EDGE 2x2M
- horizontal or vertical mounting
- in accordance with EN 60669-1OG26MAM
OG26MTM
OG26MZMOG26GDM
OG26GLM

RÁMIK EDGE 3x2M

- dekoratívny rámik EDGE 3x2M
- horizontálna alebo vertikálna inštalácia
- v súlade s normou EN 60669-1

COVER PLATE EDGE 3x2M

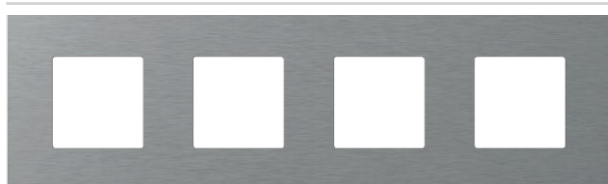
- decorative cover plate EDGE 3x2M
- horizontal or vertical mounting
- in accordance with EN 60669-1OG28MAM
OG28MTM
OG28MZMOG28GDM
OG28GLM

RÁMIK EDGE 4x2M

- dekoratívny rámik EDGE 4x2M
- horizontálna alebo vertikálna inštalácia
- v súlade s normou EN 60669-1

COVER PLATE EDGE 4x2M

- decorative cover plate EDGE 4x2M
- horizontal or vertical mounting
- in accordance with EN 60669-1



 OG13MAM	 OG13GDM
 OG13MTM	 OG13GLM
 OG13MZM	

RÁMIK EDGE 1/3M

- dekoratívny rámik EDGE 1/3M
- v súlade s normou EN 60669-1

COVER PLATE EDGE 1/3M

- decorative cover plate EDGE 1/3M
- in accordance with EN 60669-1



 OG30MAM	 OG30GDM
 OG30MTM	 OG30GLM
 OG30MZM	

RÁMIK EDGE 3M

- dekoratívny rámik EDGE 3M
- v súlade s normou EN 60669-1

COVER PLATE EDGE 3M

- decorative cover plate EDGE 3M
- in accordance with EN 60669-1



 OG40MAM	 OG40GDM
 OG40MTM	 OG40GLM
 OG40MZM	

RÁMIK EDGE 4M

- dekoratívny rámik EDGE 4M
- v súlade s normou EN 60669-1

COVER PLATE EDGE 4M

- decorative cover plate EDGE 4M
- in accordance with EN 60669-1

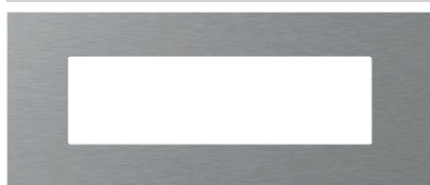

 OG70MAM	 OG70GDM
 OG70MTM	 OG70GLM
 OG70MZM	





RÁMIK EDGE 7M

- dekoratívny rámik EDGE 7M
- v súlade s normou EN 60669-1

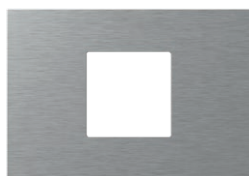
COVER PLATE EDGE 7M

- decorative cover plate EDGE 7M
- in accordance with EN 60669-1



 OG23MAM	 OG23GDM
 OG23MTM	 OG23GLM
 OG23MZM	

RÁMIK EDGE 2/3M

- dekoratívny rámik EDGE 2/3M
- v súlade s normou EN 60669-1

COVER PLATE EDGE 2/3M

- decorative cover plate EDGE 2/3M
- in accordance with EN 60669-1



MODUL
LINE

A x B



MODUL
SOFT

A x B



MODUL
PURE

A x B

1/2M

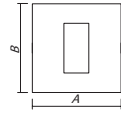

80 x 80 mm

84 x 84 mm

2M

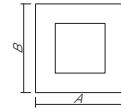

80 x 80 mm

84 x 84 mm

93 x 90 mm

2x2M

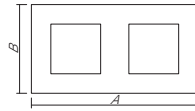

151 x 80 mm

155 x 84 mm

164 x 90 mm

3x2M

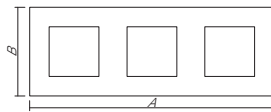

222 x 80 mm

226 x 84 mm

235 x 90 mm

4x2M

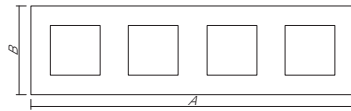

293 x 80 mm

297 x 84 mm

304 x 90 mm

5x2M

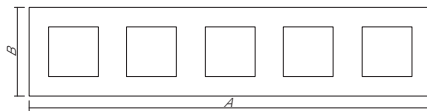

364,1 x 80 mm



1/3M

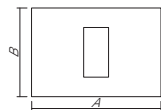

122 x 80 mm

122 x 84 mm

134 x 90 mm

3M

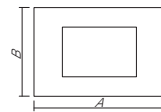

122 x 80 mm

122 x 84 mm

134 x 90 mm

4M

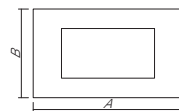

149 x 80 mm

144 x 84 mm

157 x 90 mm

7M

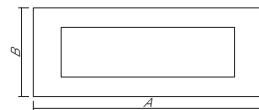

207 x 80 mm

212 x 84 mm

224 x 90 mm

2x7M

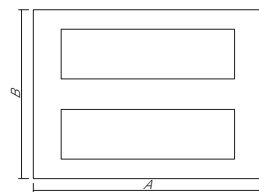

215 x 159 mm

212 x 158 mm



2/3M

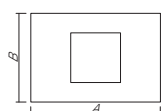

122 x 80 mm

122 x 84 mm

134 x 90 mm



MODUL
EDGE



1/2M

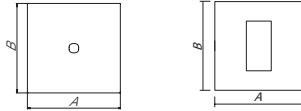

A x B

92 x 92
mm

2M

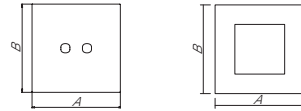

92 x 92
mm

2x2M

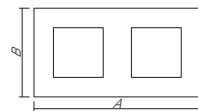

163 x 92
mm

3x2M

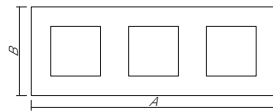

234 x 92
mm

4x2M

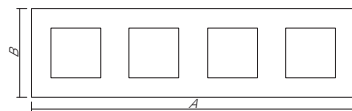

305 x 92
mm



1/3M

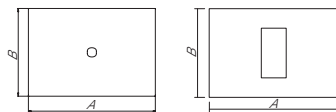

132 x 92
mm

3M

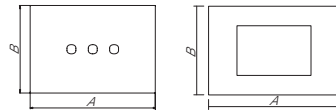

132 x 92
mm

4M

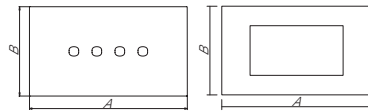

154 x 92
mm

7M

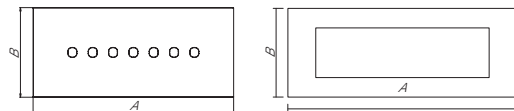

222 x 92
mm



2/3M

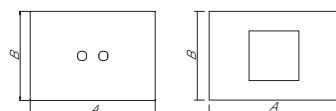

132 x 92
mm

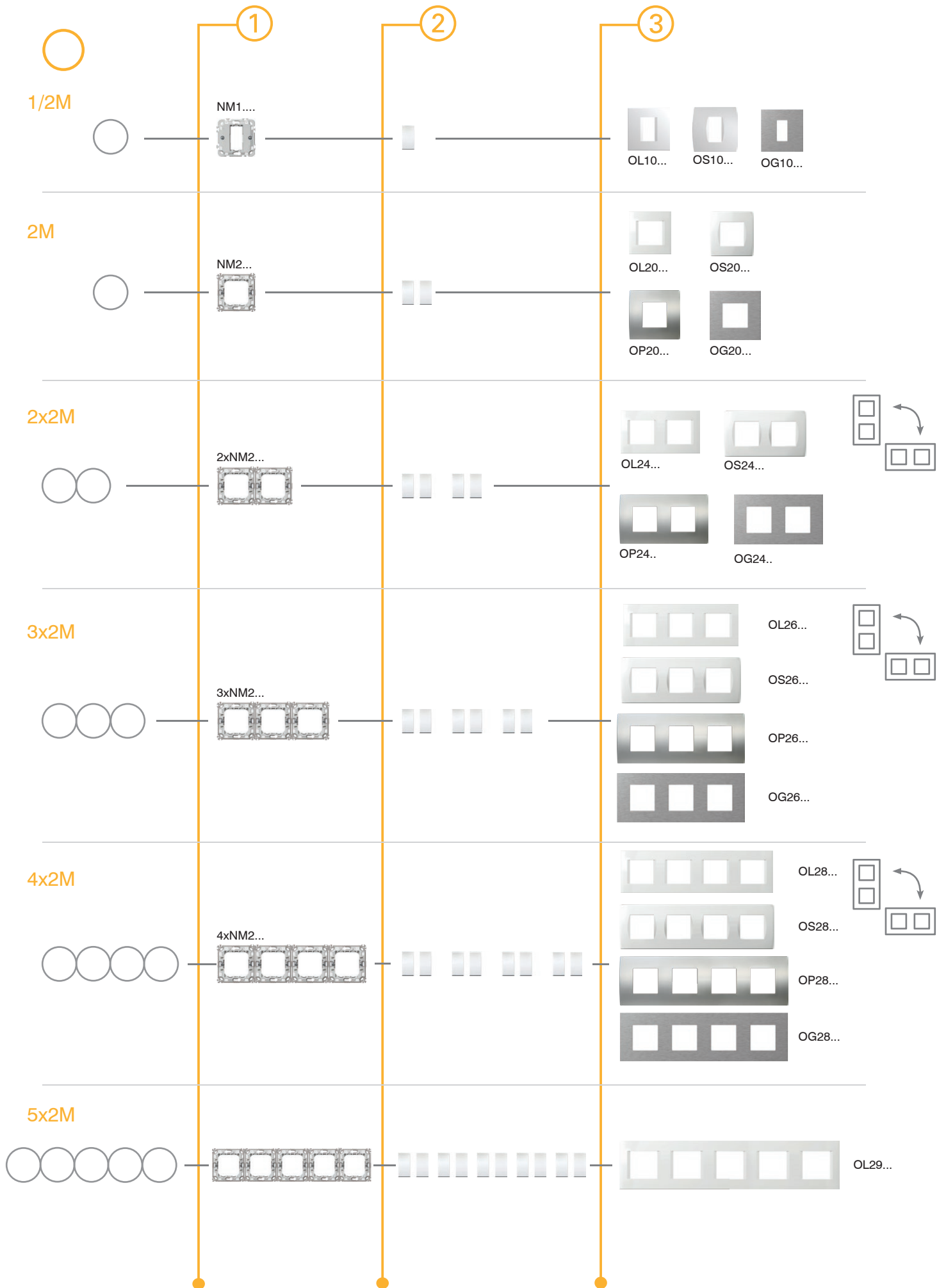

C O M B I N A T I O N S

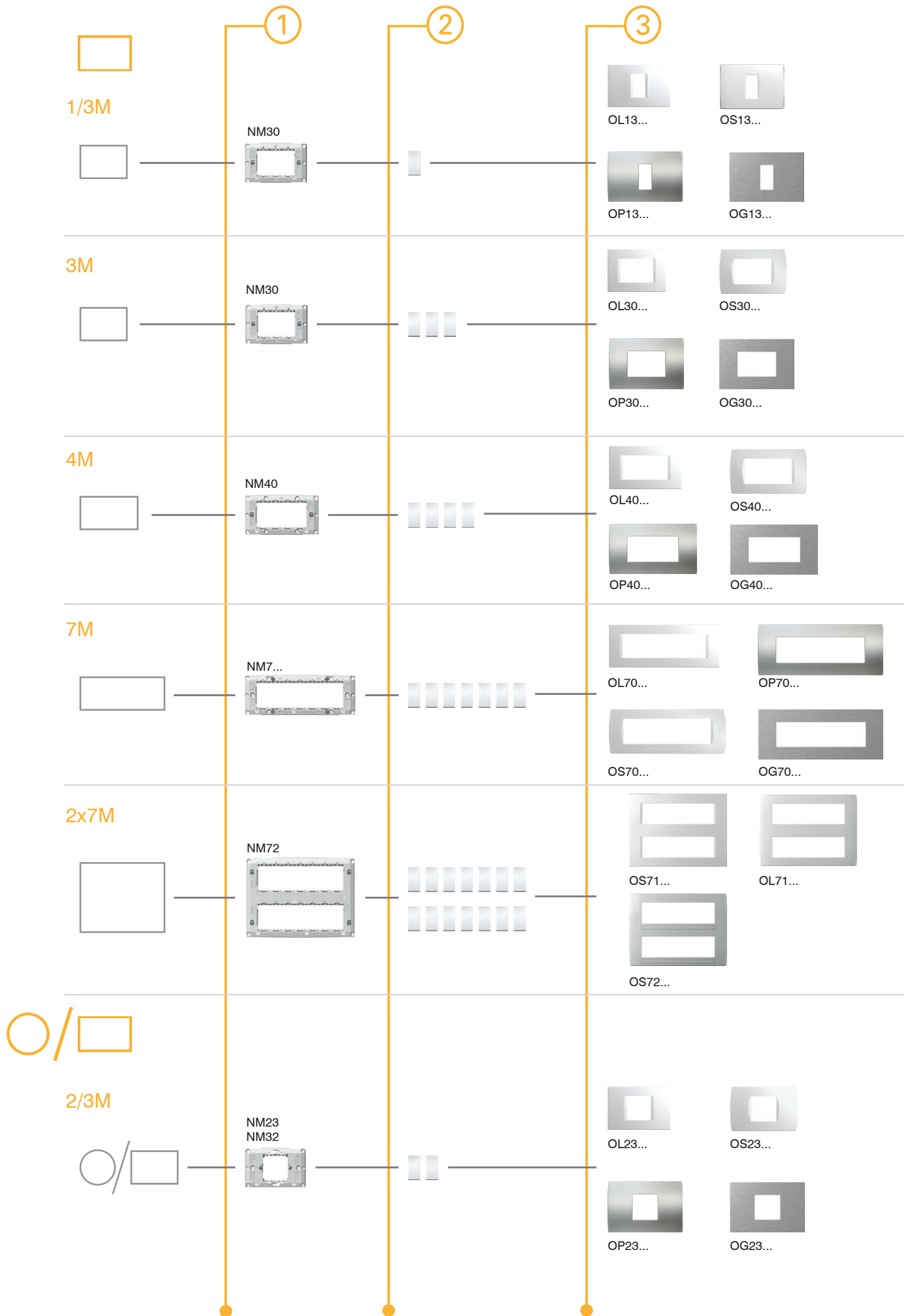

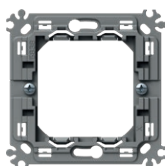

NM30

typ type	popis description	veľkosť size
NM10	MONTÁŽNY RÁM S ROZPERKAMI MOUNTING FRAME WITH CLAWS	1/2M
NM11	MONTÁŽNY RÁM BEZ SKRUTIEK MOUNTING FRAME WITHOUT SCREWS	1/2M
NM20	MONTÁŽNY RÁM S ROZPERKAMI MOUNTING FRAME WITH CLAWS	2M
...



MONTÁŽNY RÁM S ROZPERKAMI 1/2M

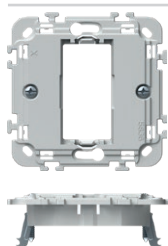

NM10

- montážny rám 1/2M s rozperkami
- montáž na škatule s priemerom Ø 60 mm (DE...) s rozperkami
- vhodné na montáž s krytmi rady LINE, SOFT a EDGE
- v súlade s normou EN 60669-1

MOUNTING FRAME WITH CLAWS 1/2M

- mounting frame 1/2M with claws
- for mounting on boxes Ø60 (DE...) with claws
- suitable for assembling with cover plates LINE, SOFT and EDGE
- in accordance with EN 60669-1

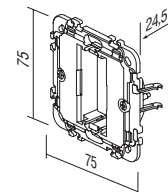

MONTÁŽNY RÁM BEZ SKRUTIEK 1/2M

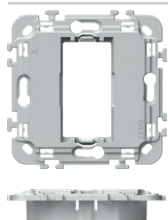

NM11

- montážny rám 1/2M bez skrutiek a rozperok
- montáž na škatule s priemerom Ø 60 mm (HE..., BE...) pomocou skrutiek
- vhodné na montáž s rámkami rady LINE, SOFT a EDGE
- v súlade s normou EN 60669-1

MOUNTING FRAME WITHOUT SCREWS 1/2M

- mounting frame 1/2M without screws and without claws
- for mounting on boxes Ø60 (HE..., BE...) with screws
- suitable for assembling with cover plates LINE, SOFT and EDGE
- in accordance with EN 60669-1

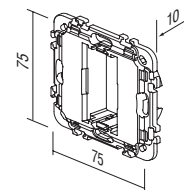

MONTÁŽNY RÁM S ROZPERKAMI 2M

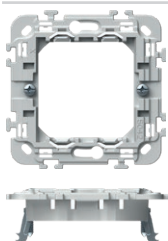

NM20

- montážny rám 2M s rozperkami
- montáž na škatule s priemerom Ø 60 mm (DE...) s rozperkami
- možná horizontálna alebo vertikálna kombinácia 2 x 2M, 3 x 2M a 4 x 2M
- vhodné na montáž s krytmi rady LINE, SOFT, PURE a EDGE
- v súlade s normou EN 60669-1

MOUNTING FRAME WITH CLAWS 2M

- mounting frame 2M with claws
- for mounting on boxes Ø60 (DE...) with claws
- possible horizontal or vertical combinations 2x2M, 3x2M and 4x2M
- suitable for assembling with cover plates LINE, SOFT, PURE and EDGE
- in accordance with EN 60669-1

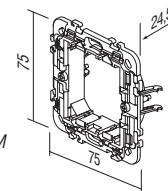

MONTÁŽNY RÁM BEZ SKRUTIEK 2M

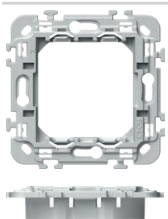

NM21

- montážny rám 2M bez skrutiek a rozperiek
- montáž na škatule s priemerom Ø 60 mm (HE..., BE...) pomocou skrutiek
- možná horizontálna alebo vertikálna kombinácia 2 x 2M, 3 x 2M a 4 x 2M
- vhodné na montáž s krytmi rady LINE, SOFT, PURE a EDGE
- v súlade s normou EN 60669-1

MOUNTING FRAME WITHOUT SCREWS 2M

- mounting frame 2M without screws and without claws
- for mounting on boxes Ø60 (HE..., BE...) with screws
- possible horizontal or vertical combinations 2x2M, 3x2M and 4x2M
- suitable for assembling with cover plates LINE, SOFT, PURE and EDGE
- in accordance with EN 60669-1

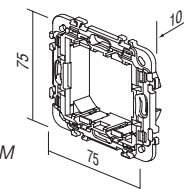

M O U N T I N G F R A M E S N M

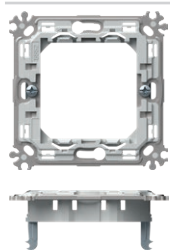

NM24

MONTÁŽNY KOVOVÝ RÁM S ROZPERKAMI 2M

- kovový montážny rám 2M s rozperkami – pevná verzia
- montáž na škatule s priemerom Ø 60 mm (DE...) s rozperkami
- možná horizontálna alebo vertikálna kombinácia 2 x 2M, 3 x 2M a 4 x 2M
- vhodné na montáž s rámkami rady LINE, SOFT, PURE a EDGE
- v súlade s normou EN 60669-1

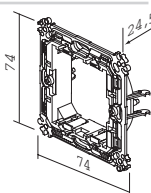

MOUNTING FRAME METAL WITH CLAWS 2M

- metal mounting frame 2M with claws - stiff version
- for mounting on boxes Ø60 (DE..) with claws
- possible horizontal or vertical combinations 2x2M, 3x2M and 4x2M
- suitable for assembling with cover plates LINE, SOFT, PURE and EDGE
- in accordance with EN 60669-1

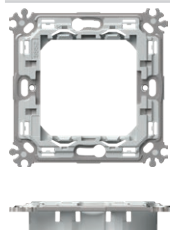

NM25

MONTÁŽNY KOVOVÝ RÁM BEZ SKRUTIEK 2M

- montážny kovový rám 2M bez skrutiek a rozperiek – pevná verzia
- montáž na škatule s priemerom Ø 60 mm (HE..., BE...) pomocou skrutiek
- možná horizontálna alebo vertikálna kombinácia 2 x 2M, 3 x 2M a 4 x 2M
- vhodné na montáž s rámkami rady LINE, SOFT, PURE a EDGE
- v súlade s normou EN 60669-1

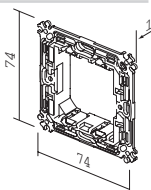

MOUNTING FRAME METAL WITHOUT SCREWS 2M

- metal mounting frame 2M without screws and without claws - stiff version
- for mounting in boxes Ø60 (HE..., BE...) with screws
- possible horizontal or vertical combinations 2x2M, 3x2M and 4x2M
- suitable for assembling with cover plates LINE, SOFT, PURE and EDGE
- in accordance with EN 60669-1

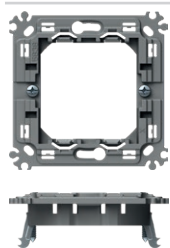

NM26

MONTÁŽNY RÁM VYSTUŽENÝ S ROZPERKAMI 2M

- montážny rám vystužený s rozperkami 2M – pevná verzia
- montáž na škatule s priemerom Ø 60 mm (DE...) s rozperkami
- možná horizontálna alebo vertikálna kombinácia 2 x 2M, 3 x 2M a 4 x 2M
- vhodné na montáž s rámkami rady LINE, SOFT, PURE a EDGE
- v súlade s normou EN 60669-1

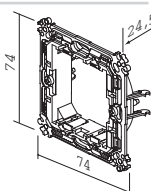

CLAW REINFORCED MOUNTING FRAME 2M

- 2M mounting frame reinforced with claws - stiff version
- for mounting on boxes Ø60 (DE..) with claws
- possible horizontal or vertical combinations 2x2M, 3x2M and 4x2M
- suitable for assembling with cover plates LINE, SOFT, PURE and EDGE
- in accordance with EN 60669-1

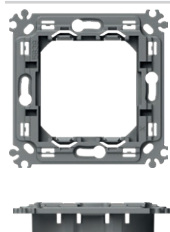

NM27

MONTÁŽNY RÁM VYSTUŽENÝ BEZ SKRUTIEK 2M

- montážny rám vystužený bez skrutiek a rozperiek – pevná verzia
- montáž na škatule s priemerom Ø 60 mm (HE..., BE...) pomocou skrutiek
- možná horizontálna alebo vertikálna kombinácia 2 x 2M, 3 x 2M a 4 x 2M
- vhodné na montáž s rámkami rady LINE, SOFT, PURE a EDGE
- v súlade s normou EN 60669-1

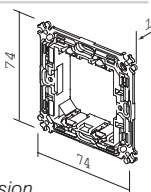

REINFORCED MOUNTING FRAME WITHOUT SCREWS 2M

- reinforced mounting frame without screws or claws - stiff version
- for mounting in boxes Ø60 (HE..., BE...) with screws
- possible horizontal or vertical combinations 2x2M, 3x2M and 4x2M
- suitable for assembling with cover plates LINE, SOFT, PURE and EDGE
- in accordance with EN 60669-1

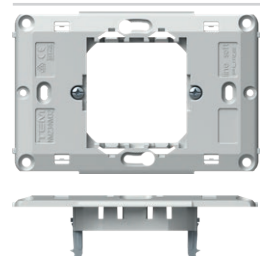

NM23

MONTÁŽNY RÁM S ROZPERKAMI 2/3M

- montážny rám 2/3M so svorkami
- montáž na škatule s priemerom Ø 60 mm (DE...) s rozperkami
- vhodné na montáž s rámkami rady LINE, SOFT, PURE a EDGE
- v súlade s normou EN 60669-1

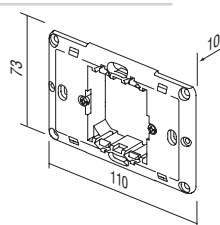

MOUNTING FRAME WITH CLAWS 2/3M

- mounting frame 2/3M with claws
- for mounting on boxes Ø60 (DE..) with claws
- suitable for assembling with cover plates LINE, SOFT, PURE and EDGE
- in accordance with EN 60669-1



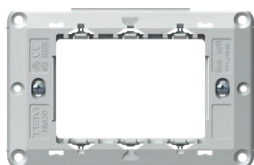

NM30

MONTÁŽNY RÁM SO SKRUTKAMI 3M

- montážny rám 3M so skrutkami
- pre montáž na obdĺžnikové krabice 3M
- vhodné na montáž s rámkami rady LINE, SOFT, PURE a EDGE
- v súlade s normou EN 60669-1

MOUNTING FRAME WITH SCREWS 3M

- mounting frame 3M with screws
- for mounting on rectangular boxes 3M
- suitable for assembling with cover plates LINE, SOFT, PURE and EDGE
- in accordance with EN 60669-1

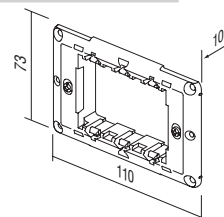

NM40

MONTÁŽNY RÁM SO SKRUTKAMI 4M

- montážny rám 4M so skrutkami
- pre montáž na obdĺžnikové krabice 4M
- vhodné na montáž s rámkami rady LINE, SOFT, PURE a EDGE
- v súlade s normou EN 60669-1

MOUNTING FRAME WITH SCREWS 4M

- mounting frame 4M with screws
- for mounting on rectangular boxes 4M
- suitable for assembling with cover plates LINE, SOFT, PURE and EDGE
- in accordance with EN 60669-1

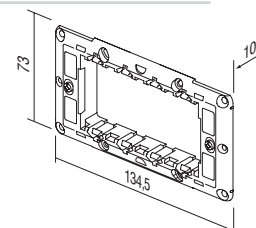

NM70

MONTÁŽNY RÁM SO SKRUTKAMI 7M

- montážny rám 7M so skrutkami
- pre montáž na obdĺžnikové krabice 7M
- vhodné na montáž s rámkami rady LINE, SOFT, PURE a EDGE
- v súlade s normou EN 60669-1

MOUNTING FRAME WITH SCREWS 7M

- mounting frame 7M with screws
- for mounting on rectangular boxes 7M
- suitable for assembling with cover plates 7M
- in accordance with EN 60669-1

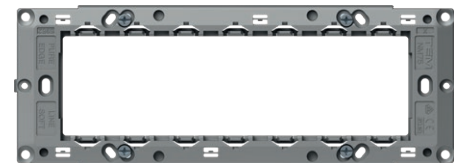
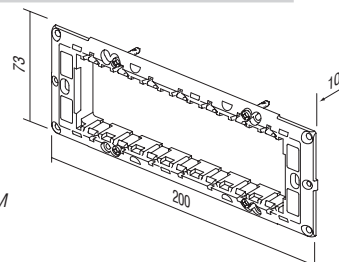

NM75

MONTÁŽNY RÁM VYSTUŽENÝ 7M ROZPERKAMI

- montážny rám vystužený 7M rozperkami – pevná verzia
- inštalácia do obdĺžnikových krabíc veľkosti 7M – vhodné na montáž s rámkami 7M
- v súlade s normou EN 60669-1

REINFORCED MOUNTING FRAME WITH SCREWS 7M

- reinforced mounting frame 7M with screws – stiff version
- for mounting on rectangular boxes 7M
- suitable for assembling with cover plates 7M
- in accordance with EN 60669-1

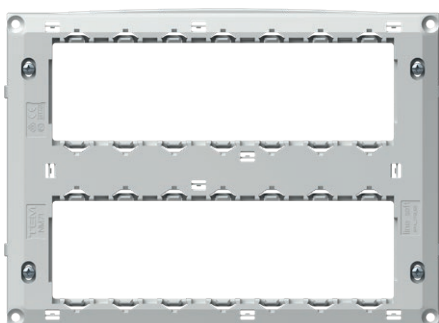
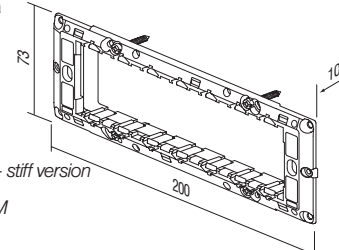

NM72

MONTÁŽNY RÁM SO SKRUTKAMI 2 x 7M

- montážny rám 2x7M so skrutkami
- pre montáž na obdĺžnikové krabice 2 x 7M
- vhodné pre montáž s rámkami rady 2x7M
- v súlade s normou EN 60669-1

MOUNTING FRAME WITH SCREWS 2x7M

- mounting frame 2x7M with screws
- for mounting on rectangular boxes 2x7M
- suitable for assembling with cover plates 2x7M
- in accordance with EN 60669-1

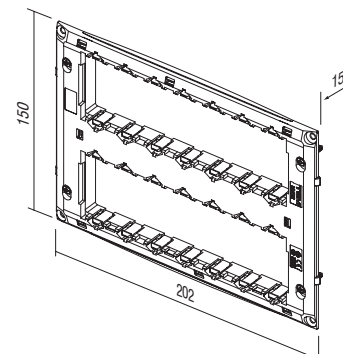

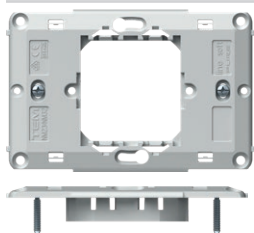

NM32

MONTÁŽNY RÁM SO SKRUTKAMI 2/3M

- montážny rám 2/3M so skrutkami
- pre montáž na obdĺžnikové krabice 3M
- vhodné na montáž s rámkami rady LINE, SOFT, PURE a EDGE
- v súlade s normou EN 60669-1

MOUNTING FRAME WITH SCREWS 2/3M

- mounting frame 2/3M with screws
- for mounting on rectangular boxes 3M
- suitable for assembling with cover plates LINE, SOFT, PURE and EDGE
- in accordance with EN 60669-1

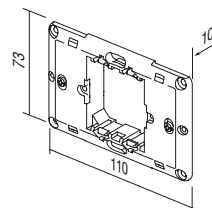



136



144



152



154

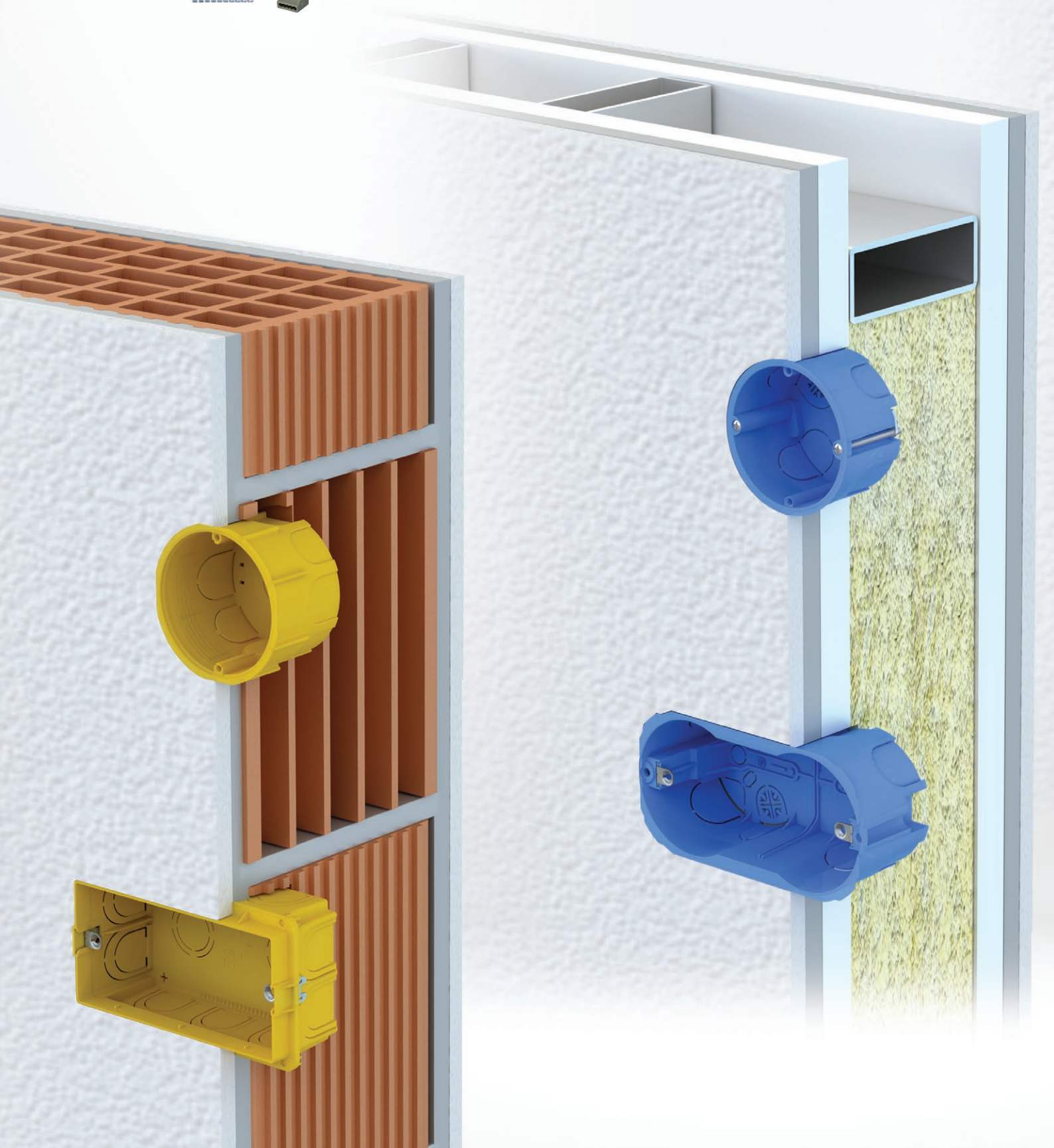



KRABICE

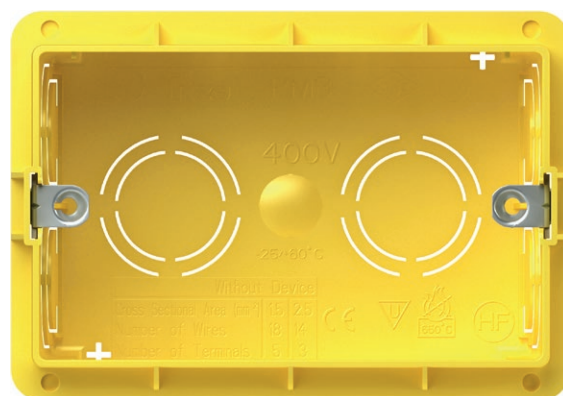

TEM



DE12



HE11



BE10

typ type	popis description	veľkosť size
DE10	OKRÚHLA KRABICA DO STENY ROUND BOX BRICK	SM60-01
HE10	OKRÚHLA KRABICA – DUTÁ PRIEČKA ROUND BOX HOLLOW WALL	SM68X40
BE10	OKRÚHLA KRABICA – BETÓN ROUND BOX CONCRETE	
·	·	·
·	·	·

OKRÚHLA KRABICA DO STENY SM60-01



DE10

- Ø 60, hĺbka 40 mm
- 650 °C, 500 V ~
- v súlade s normou IEC 60670-1
- bezhalogénová
- možnosť upevnenia konzoly pomocou skrutiek Ø 3 mm

ROUND BOX BRICK SM60-01

- Ø60, depth 40mm
- 650°C, 500V~
- in accordance with IEC 60670-1
- halogen free
- option of mounting the mounting frame with Ø 3 mm screws

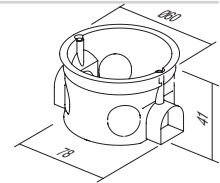

OKRÚHLA KRABICA DO STENY HLBOKÁ SM60-06



DE11

- Ø 60, hĺbka 60mm
- 650 °C, 500 V ~
- v súlade s normou IEC 60670-1
- bezhalogénová
- možnosť upevnenia konzoly pomocou skrutiek Ø 3 mm

ROUND BOX BRICK DEEP SM60-06

- Ø60, depth 60mm
- 650°C, 500V~
- in accordance with IEC 60670-1
- halogen free
- option of mounting the mounting frame with Ø 3 mm screws

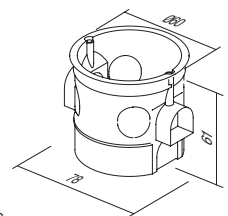

SPOJOVACÍ ČLÁNOK NA KRABICE DO STENY SM60-03



DE30

- na vertikálne spojenie krabic SM60-06 alebo SM60-01 vo vzdialenosti 91 mm
- v súlade s normou IEC 60670-1
- bezhalogénová

COMBI-CLIP SM60-03

- for vertical fitting of boxes SM60-06 or SM60-01 on distance 91 mm
- in accordance with IEC 60670-1
- halogen free

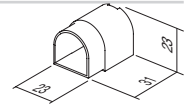

SPOJOVACÍ ČLÁNOK NA KRABICE DO STENY SM60-04

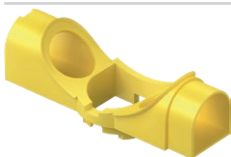

DE31







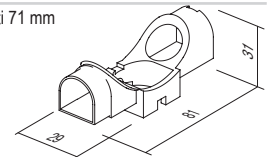



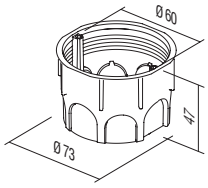

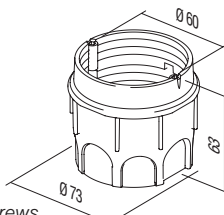

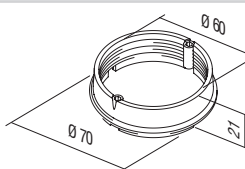
- na horizontálnu montáž krabic SM60-06 alebo SM60-01 vo vzdialenosti 71 mm
- v súlade s normou IEC 60670-1
- bezhalogénová

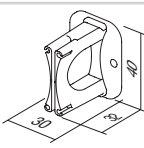
COMBI-CLIP SM60-04

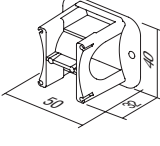
- for horizontal fitting of boxes SM60-06 or SM60-01 on distance 71mm
- in accordance with IEC 60670-1
- halogen free

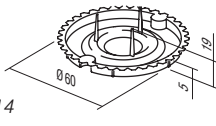

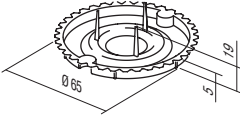
R O U N D B O X E S

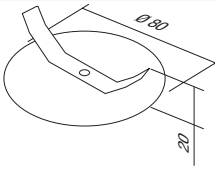
	DE12	OKRÚHLA KRABICA DO STENY MD65-46	<ul style="list-style-type: none"> - Ø 65, hĺbka 46 mm - 650 °C, 500 V ~ - v súlade s normou IEC 60670-1 - bezhalogénová - možnosť upevnenia konzoly pomocou skrutiek Ø 3 mm 	
			<p><i>ROUND BOX BRICK MD65-46</i></p> <ul style="list-style-type: none"> - Ø65, depth 46mm - 650°C, 500V~ - in accordance with IEC 60670-1 - halogen free - option of mounting the mounting frame with Ø 3 mm screws 	
	DE13	OKRÚHLA KRABICA DO STENY HLBOKÁ MD65-60	<ul style="list-style-type: none"> - Ø 65/60, hĺbka 62 mm - 650 °C, 500 V ~ - v súlade s normou IEC 60670-1 - bezhalogénová - možnosť upevnenia konzoly pomocou skrutiek Ø 3 mm 	
			<p><i>ROUND BOX BRICK DEEP MD65-60</i></p> <ul style="list-style-type: none"> - Ø65/60, depth 62mm - 650°C, 500V~ - in accordance with IEC 60670-1 - halogen free - option of mounting the mounting frame with Ø 3 mm screws 	
	DE14	PREHLBENIE PRE MD65-46	<ul style="list-style-type: none"> - Ø 65/60, hĺbka 17mm - 650 °C, 500 V ~ - v súlade s normou IEC 60670-1 - bezhalogénová 	
			<p><i>ADDITIONAL PIECE FOR MD65-46</i></p> <ul style="list-style-type: none"> - Ø65/60, depth 17mm - 650°C, 500V~ - in accordance with IEC 60670-1 - halogen free 	
	DE32	SPOJOVACÍ ČLÁNOK NA KRABICE DO STENY MD65-71	<ul style="list-style-type: none"> - na montáž krabic MD65 na vzdialenosť 71 mm - v súlade s normou IEC 60670-1 - bezhalogénová 	
			<p><i>COMBI-CLIP MD65-71</i></p> <ul style="list-style-type: none"> - for fitting of boxes MD65 on distance 71mm - in accordance with IEC 60670-1 - halogen free 	
	DE33	SPOJOVACÍ ČLÁNOK NA KRABICE DO STENY MD65-91	<ul style="list-style-type: none"> - na montáž krabic MD65 na vzdialenosť 91mm - v súlade s normou IEC 60670-1 - bezhalogénová 	
			<p><i>COMBI-CLIP MD65-91</i></p> <ul style="list-style-type: none"> - for fitting of boxes MD65 on distance 91mm - in accordance with IEC 60670-1 - halogen free 	
	DE20	OCHRANNÝ KRYT KRABICE 60	<ul style="list-style-type: none"> - ochranný kryt na krabice Ø 60 pre DE10, DE11, DE13, DE14 - v súlade s normou IEC 60670-1 - ochrana krabice počas omietania 	
			<p><i>BOX COVER PROTECTIVE 60</i></p> <ul style="list-style-type: none"> - protective cover for box Ø60 for DE10, DE11, DE13, DE14 - in accordance with IEC 60670-1 - box protection during plastering 	
	DE21	OCHRANNÝ KRYT KRABICE 65	<ul style="list-style-type: none"> - ochranný kryt na krabice Ø 65 pre DE12 - v súlade s normou IEC 60670-1 - ochrana krabice počas omietania 	
			<p><i>BOX COVER PROTECTIVE 65</i></p> <ul style="list-style-type: none"> - protective cover for box Ø65 for DE12 - in accordance with IEC 60670-1 - box protection during plastering 	
	DE22	KRYT KRABICE SM60	<ul style="list-style-type: none"> - kryt na krabice Ø 60 mm - v súlade s normou IEC 60670-1 - bezhalogénová 	
			<p><i>BOX COVER DECORATIVE SM60</i></p> <ul style="list-style-type: none"> - decorative cover for boxes Ø60 - in accordance with IEC 60670-1 - halogen free 	



pokyny na montáž /
assembly instructions

vzdialenosť medzi krabicami /
distance between boxes: 71 mm

vzdialenosť medzi krabicami /
distance between boxes: 91 mm

DE10,11

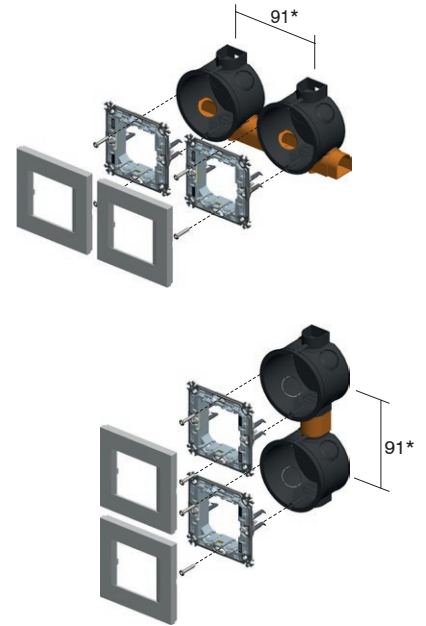
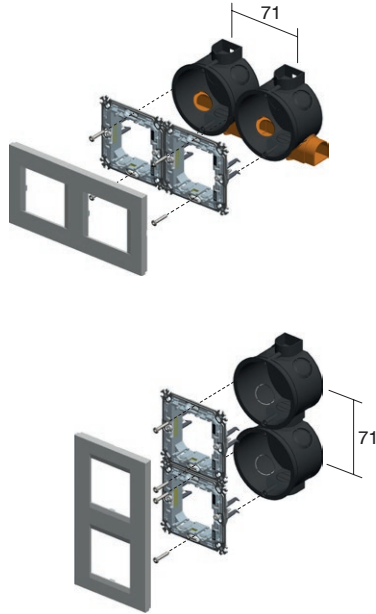
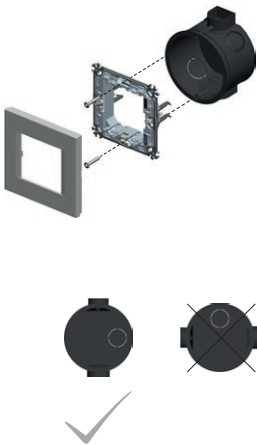

DE12,13

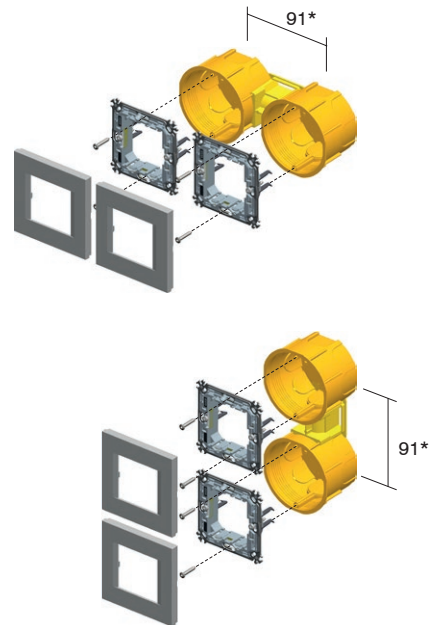
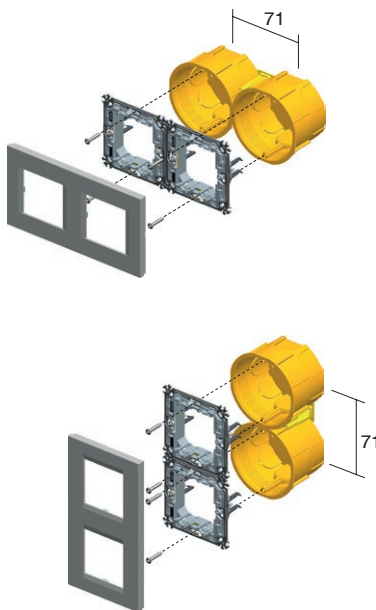
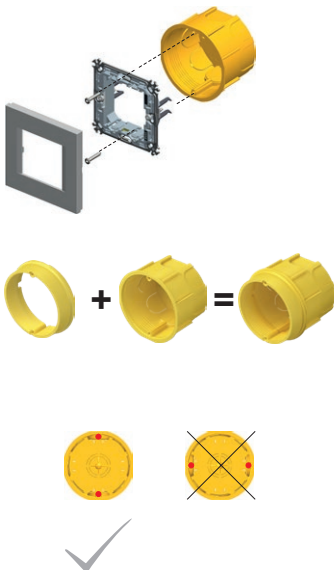

* Pri rámkoch rady PURE, EDGE je minimálna vzdialenosť medzi krabicami 100 mm
* for PURE, EDGE cover plates the minimum distance between boxes is 100mm

R O U N D B O X E S



DE10,11



DE12,13



NM20



NM24,26



DE10,11



DE12,13



NM10



DE10,11



DE12,13



NM23



71

2xDE10,11 + 2xDE31



2xDE12,13 + 1xDE32



2xNM20



2xNM24,26



2xDE10,11



2xDE12,13 + 1xDE32



2xNM20



2xNM24,26



3xDE10,11 + 3xDE31



3xDE12,13 + 2xDE32



3xNM20



3xNM24,26

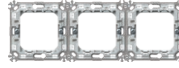

3xDE10,11



3xDE12,13 + 2xDE32



3xNM20



3xNM24,26



4xDE10,11 + 4xDE31



4xDE12,13 + 3xDE32



4xNM20



4xNM24,26



4xDE10,11



4xDE12,13 + 3xDE32



4xNM20



4xNM24,26



5xDE10,11



5xDE12,13 + 4xDE32



5xNM20



5xNM24,26



OKRŮHLA KRABICA – DUTÁ PRIEČKA SM68x40



HE10

- Ø 60 mm, hĺbka 40 mm
- montážny otvor Ø68 mm
- 850 °C, 400 V ~
- v súlade s normou IEC 60670-1
- montáž so svorkami
- bezhalogénová
- upevnenie konzoly skrutkami Ø 3 mm

ROUND BOX HOLLOW WALL SM68x40

- Ø60, depth 40mm
- cutting hole Ø68
- 850°C, 400V~
- in accordance with IEC 60670-1
- mounting with claws
- halogen free
- mounting the mounting frame with Ø 3 mm screws

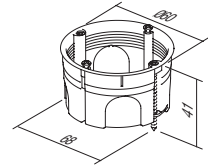

OKRŮHLA KRABICA – DUTÁ PRIEČKA SM68x55



HE11

- Ø 60 mm, hĺbka 55mm
- montážny otvor Ø68 mm
- 850 °C, 400 V ~
- v súlade s normou IEC 60670-1
- montáž so svorkami
- bezhalogénová
- upevnenie konzoly skrutkami Ø 3 mm

ROUND BOX HOLLOW WALL SM68x55

- Ø60, depth 55mm
- cutting hole Ø68
- 850°C, 400V~
- in accordance with IEC 60670-1
- mounting with claws
- halogen free
- mounting the mounting frame with Ø 3 mm screws

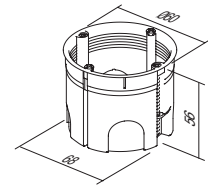

OKRŮHLA KRABICA – BETÓN



BE10

- Ø 60mm, hĺbka 49 mm
- 650 °C, 500 V ~
- v súlade s normou IEC 60670-1
- bezhalogénová
- upevnenie konzoly skrutkami Ø 3 mm

ROUND BOX CONCRETE

- Ø60mm, depth 49mm
- 650°C, 500V~
- in accordance with IEC 60670-1
- halogen free
- mounting the mounting frame with Ø 3 mm screws

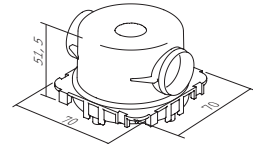

OKRŮHLA KRABICA – BETÓN HLBOKÁ



BE11

- Ø 60mm, hĺbka 58mm
- 650 °C, 500 V ~
- v súlade s normou IEC 60670-1
- bezhalogénová
- upevnenie konzoly skrutkami Ø 3 mm

ROUND BOX CONCRETE DEEP

- Ø60mm, depth 58mm
- 650°C, 500V~
- in accordance with IEC 60670-1
- halogen free
- mounting the mounting frame with Ø 3 mm screws

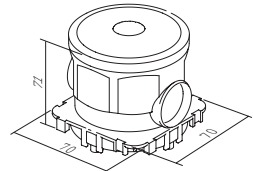

MONTÁŽNY RÁM KRABICE DO BETÓNU



BE20

- na upevnenie krabice s dištančným profilom BM82 pre extrémne zaťaženie
- v súlade s normou IEC 60670-1
- bezhalogénová

COUNTER BOX SUPPORT CONCRETE

- to support concrete boxes with discance profile BM82 for extreme loads
- in accordance with IEC 60670-1
- halogen free

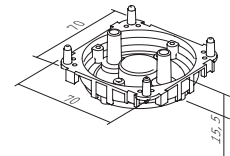

PRIECHODKA KRABICE DO BETÓNU 16



BE21

- na upevnenie inštalačnej rúry k krabici
- v súlade s normou IEC 60670-1
- bezhalogénová

PIPE STOPPER CONCRETE BOX 16

- for firming installation pipe to box
- in accordance with IEC 60670-1
- halogen free

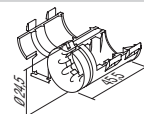

R O U N D B O X E S

duté priečky / hollow walls

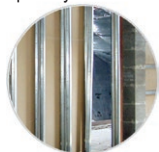

betón / concrete



pokyny na montáž /
assembly instructions

vzdialenosť medzi krabicami /
distance between boxes: 71 mm

vzdialenosť medzi krabicami /
distance between boxes: 91 mm

HE10,11

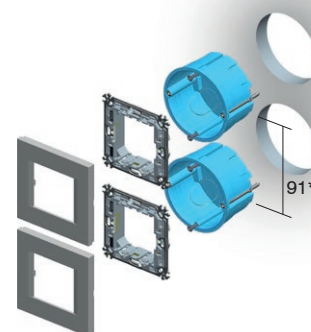
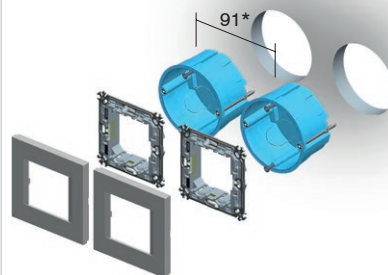
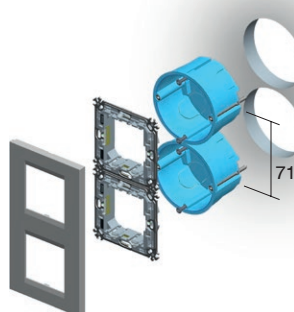
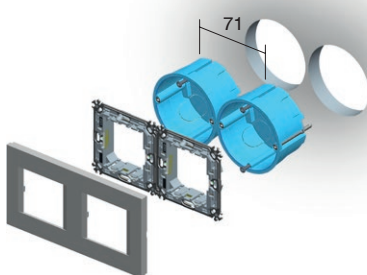
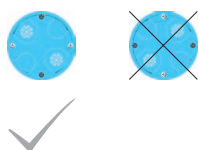
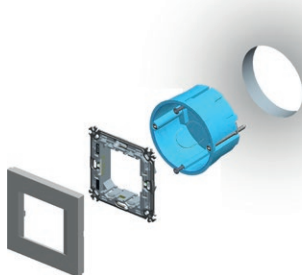

BE10

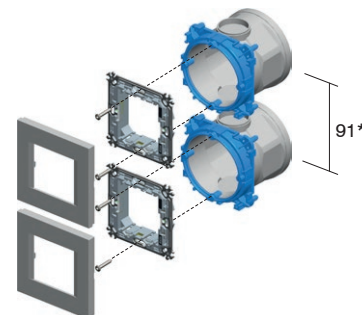
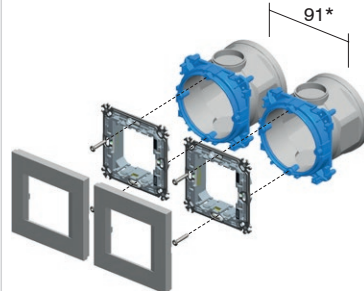
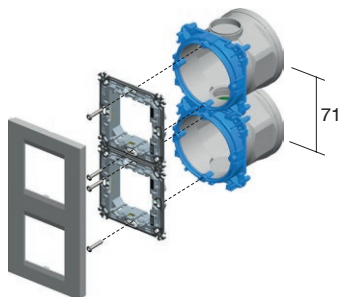
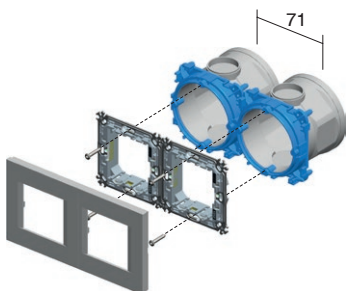
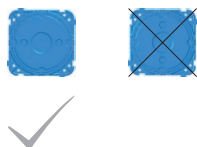
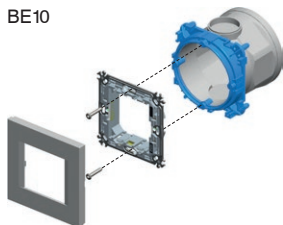

* Pri rámkoch rady PURE, EDGE je minimálna vzdialenosť medzi krabicami 100 mm

* for PURE, EDGE cover plates the minimum distance between boxes is 100mm

OKRÚHLE KRABICE

duté priečky / hollow walls



betón / concrete



HE10,11



BE10,11



NM21



NM25,27



2M

HE10,11



BE10,11



NM11



1/2M

2xHE10,11



2xBE10,11



2xNM21



2xNM25,27



2x2M

HE10,11



BE10,11



NM32

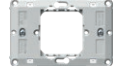

2/3M

2xHE10,11



2xBE10,11



2xNM21



2xNM25,27



5xHE10,11



5xNM21



5xBE10,11



5xNM25,27



5x2M

3xHE10,11



3xBE10,11



3xNM21



3xNM25,27



3x2M

3xHE10,11



3xBE10,11



3xNM21



3xNM25,27

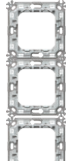

4xHE10,11



4xBE10,11



4xNM21



4xNM25,27



4x2M

4xHE10,11



4xBE10,11



4xNM21



4xNM25,27



R O U N D B O X E S

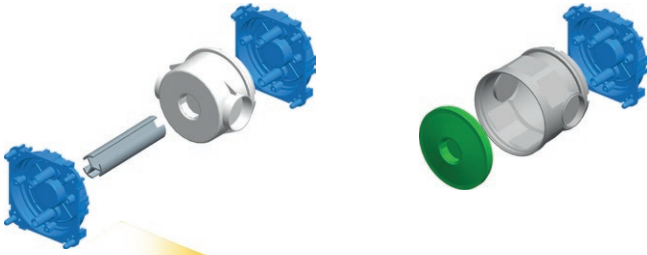

pokyny na montáž /
assembly instructions

1

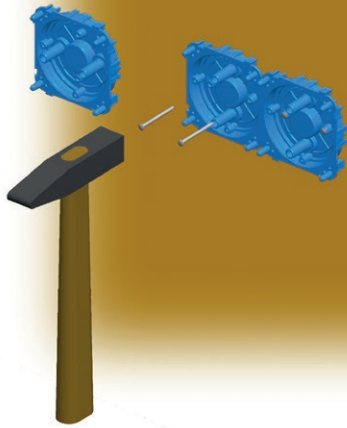

2

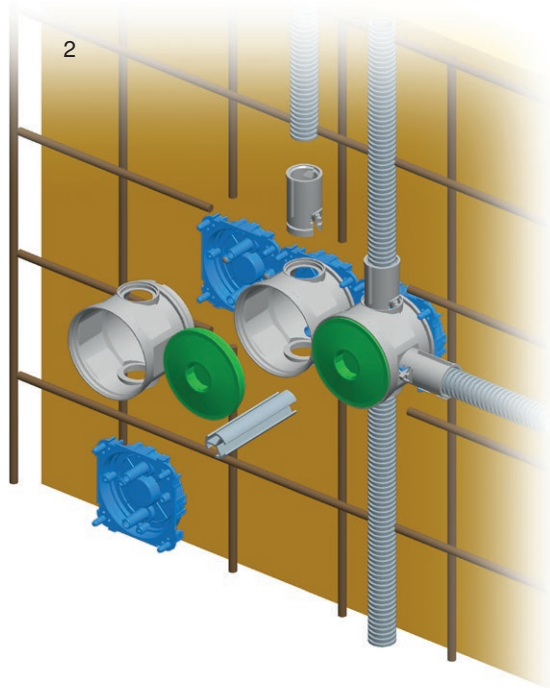

3

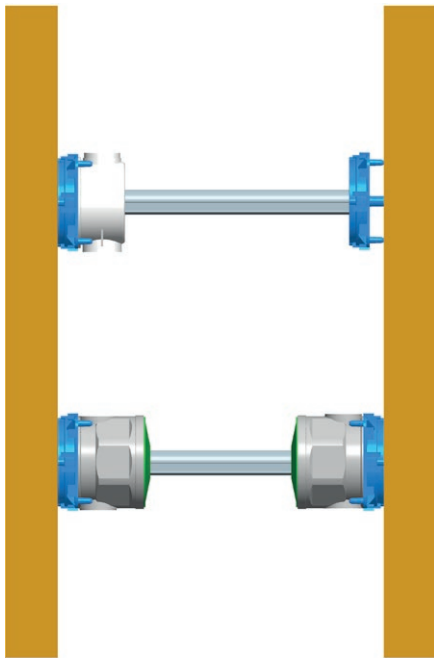

4

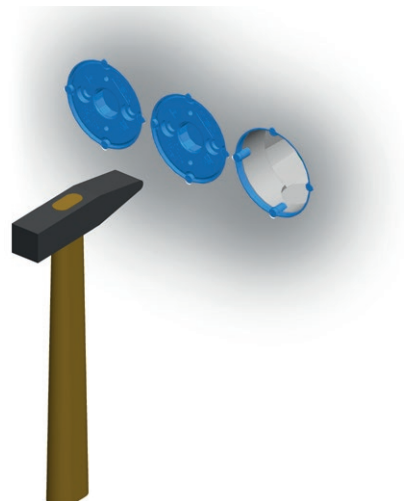



DM30



HM30



BM30

typ type	popis description	velkosť size
DM30	OBDĚŽNIKOVÁ KRABICA DO STĚNY RECTANGULAR BOX BRICK	PM3
HM30	OBDĚŽNIKOVÁ KRABICA – DUTÉ PRIEČKY RECTANGULAR BOX HOLLOW WALL	VM3
BM30	OBDĚŽNIKOVÁ KRABICA – BETÓN RECTANGULAR BOX CONCRETE	BM3
·	·	·
·	·	·

OBDĚŽNIKOVÁ KRABICA DO STĚNY PM3



DM30

- veľkosť 3M, hĺbka 49 mm
- 650 °C, 400 V ~
- v súlade s normou IEC 60670-1
- bezhalogénová

RECTANGULAR BOX BRICK PM3

- size 3M, depth 49mm
- 650 °C, 400V~
- in accordance with IEC 60670-1
- halogen free

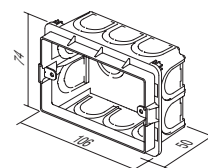

OBDĚŽNIKOVÁ KRABICA DO STĚNY PM3-65



DM31

- veľkosť 3M, hĺbka 65 mm
- 650 °C, 400 V ~
- v súlade s normou IEC 60670-1
- bezhalogénová

RECTANGULAR BOX BRICK PM3-65

- size 3M, depth 65mm
- 650 °C, 400V~
- in accordance with IEC 60670-1
- halogen free

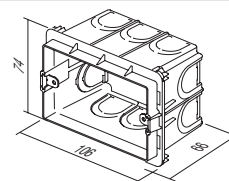

OBDĚŽNIKOVÁ KRABICA DO STĚNY PM4



DM40

- veľkosť 4M, hĺbka 49 mm
- 650 °C, 400 V ~
- v súlade s normou IEC 60670-1
- bezhalogénová

RECTANGULAR BOX BRICK PM4

- size 4M, depth 49mm
- 650 °C, 400V~
- in accordance with IEC 60670-1
- halogen free

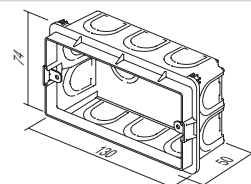

OBDĚŽNIKOVÁ KRABICA DO STĚNY PM4-65



DM41

- veľkosť 4M, hĺbka 65 mm
- 650 °C, 400 V ~
- v súlade s normou IEC 60670-1
- bezhalogénová

RECTANGULAR BOX BRICK PM4-65

- size 4M, depth 65mm
- 650 °C, 400V~
- in accordance with IEC 60670-1
- halogen free

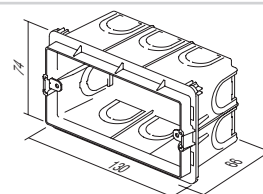

R E C T A N G U L A R B O X E S

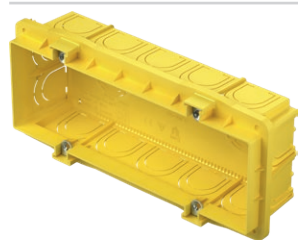

DM70

OBDĹŽNIKOVÁ KRABICA DO STENY PM7

- veľkosť 7M, hĺbka 49 mm
- 650 °C, 400 V ~
- v súlade s normou IEC 60670-1
- bezhalogénová

RECTANGULAR BOX BRICK PM7

- size 7M, depth 49mm
- 650 °C, 400V~
- in accordance with IEC 60670-1
- halogen free

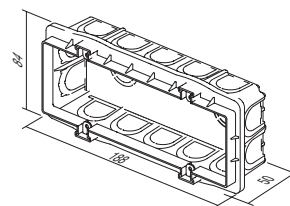

DM71

OBDĹŽNIKOVÁ KRABICA DO STENY PM7-65

- veľkosť 7M, hĺbka 65 mm
- 650 °C, 400 V ~
- v súlade s normou IEC 60670-1
- bezhalogénová

RECTANGULAR BOX BRICK PM7-65

- size 7M, depth 65mm
- 650 °C, 400V~
- in accordance with IEC 60670-1
- halogen free

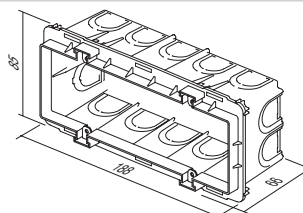

DM72

OBDĹŽNIKOVÁ KRABICA DO STENY PM72-65

- veľkosť 2 x 7M, hĺbka 64 mm
- 650 °C, 400 V ~
- v súlade s normou IEC 60670-1
- bezhalogénová

RECTANGULAR BOX BRICK PM72-65

- size 2x7M, depth 64mm
- 650 °C, 400V~
- in accordance with IEC 60670-1
- halogen free

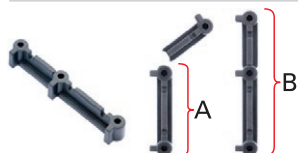
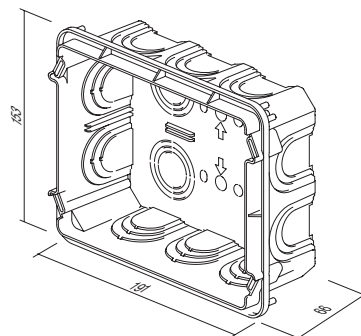

DM80

ROZPERA PRE KRABICU PM

- na vertikálnu (A) a horizontálnu (B) montáž krabic PM3, PM4 a PM7
- vhodné pre dekoratívne krycie lišty Line a Soft (nie pre PURE,EDGE)

DISTANCE PIECE FOR BOX PM

- for vertical (A) and horizontal (B) fitting of boxes PM3, PM4 and PM7
- suitable for Line and Soft decorative cover plates (not for PURE and EDGE)

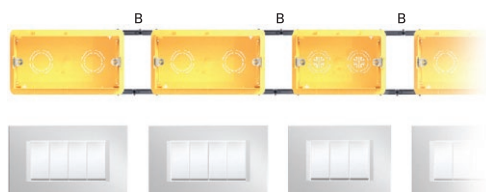
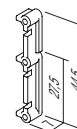

OCHRANNÝ KRYT PM3



DM33

- ochranný kryt pre krabicu PM3
- v súlade s normou IEC 60670-1
- bezhalogénová
- ochrana krabice počas omietania

BOX COVER PROTECTIVE PM3

- protective cover for box PM3
- in accordance with IEC 60670-1
- halogen free
- box protection during plastering

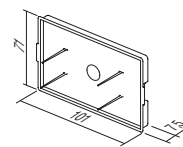

KRYT KRABICE DEKORATÍVNY PM3



DM34

- dekoratívny kryt pre krabicu 3M
- skrutky sú súčasťou dodávky
- v súlade s normou IEC 60670-1
- bezhalogénová

BOX COVER DECORATIVE PM3

- decorative cover for boxes 3M
- screws are included
- in accordance with IEC 60670-1
- halogen free

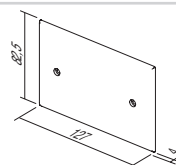

OCHRANNÝ KRYT PM4



DM43

- ochranný kryt pre krabicu PM4
- v súlade s normou IEC 60670-1
- bezhalogénová
- ochrana krabice počas omietania

BOX COVER PROTECTIVE PM4

- protective cover for box PM4
- in accordance with IEC 60670-1
- halogen free
- box protection during plastering

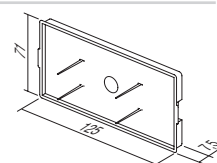

KRYT KRABICE DEKORATÍVNY PM4



DM44

- dekoratívny kryt pre krabicu 4M
- skrutky sú súčasťou dodávky
- v súlade s normou IEC 60670-1
- bezhalogénová

BOX COVER DECORATIVE PM4

- decorative cover for boxes 4M
- screws are included
- in accordance with IEC 60670-1
- halogen free

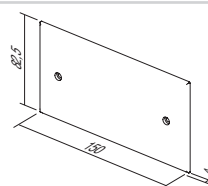

OCHRANNÝ KRYT PM7

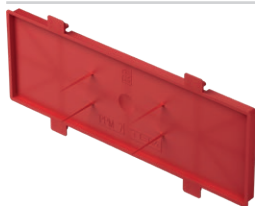

DM73

- ochranný kryt pre krabicu PM7
- v súlade s normou IEC 60670-1
- bezhalogénová
- ochrana krabice počas omietania

BOX COVER PROTECTIVE PM7

- protective cover for box PM7
- in accordance with IEC 60670-1
- halogen free
- box protection during plastering

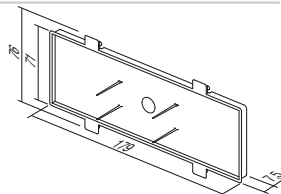

KRYT KRABICE DEKORATÍVNY PM7



DM74

- dekoratívny kryt pre krabicu 7M
- skrutky sú súčasťou dodávky
- v súlade s normou IEC 60670-1
- bezhalogénová

BOX COVER DECORATIVE PM7

- decorative cover for boxes 7M
- screws are included
- in accordance with IEC 60670-1
- halogen free

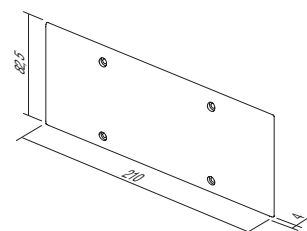

R E C T A N G U L A R B O X E S



DM75

KRYT KRABICE DEKORATIVNY PM72

- dekoratívny kryt pre krabice 2 x 7M
- skrutky sú súčasťou dodávky
- v súlade s normou IEC 60670-1

BOX COVER DECORATIVE PM72

- decorative cover for boxes 2x7M
- screws are included
- in accordance with IEC 60670-1

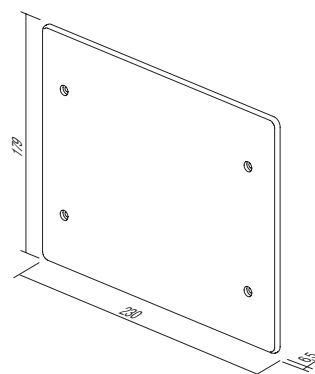

OVÁLNÁ KRABICA – DUTÁ PRIEČKA VM3



HM30

- veľkosť 3M, hĺbka 49 mm
- montážny otvor 2 x Ø 68/45 mm
- 850 °C, 400 V ~
- v súlade s normou IEC 60670-1
- bezhalogénová

RECTANGULAR BOX HOLLOW WALL VM3

- size 3M, depth 49mm
- cutting hole 2xØ68/45mm
- 850°C, 400V~
- in accordance with IEC 60670-1
- halogen free

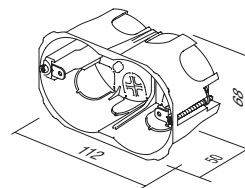

OVÁLNÁ KRABICA – DUTÁ PRIEČKA VM4



HM40

- veľkosť 4M, hĺbka 49 mm
- montážny otvor 2 x Ø 68/70 mm
- 850 °C, 400 V ~
- v súlade s normou IEC 60670-1
- bezhalogénová

RECTANGULAR BOX HOLLOW WALL VM4

- size 4M, depth 49mm
- cutting hole 2xØ68/70mm
- 850°C, 400V~
- in accordance with IEC 60670-1
- halogen free

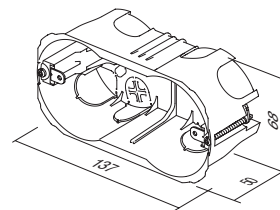

OVÁLNÁ KRABICA – DUTÁ PRIEČKA VM7



HM70

- veľkosť 7M, hĺbka 49 mm
- montážny otvor 2 x Ø 68/120 mm
- 850 °C, 400 V ~
- v súlade s normou IEC 60670-1
- bezhalogénová

RECTANGULAR BOX HOLLOW WALL VM7

- size 7M, depth 49mm
- cutting hole 2xØ68/120mm
- 850°C, 400V~
- in accordance with IEC 60670-1
- halogen free

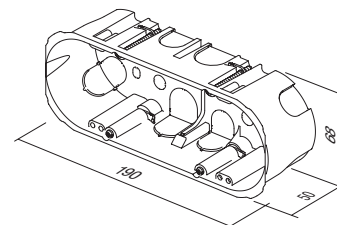

OBDĽŽNIKOVÁ KRABICA – DUTÁ PRIEČKA VM72



HM72







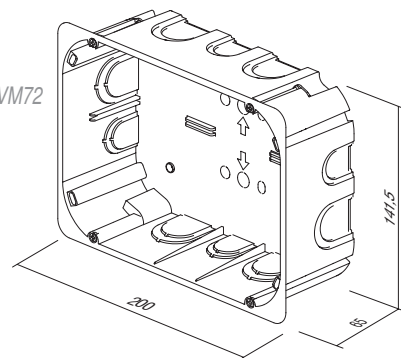

- veľkosť 2 x 7M, hĺbka 63 mm
- 850 °C, 400 V ~
- v súlade s normou IEC 60670-1
- bezhalogénová

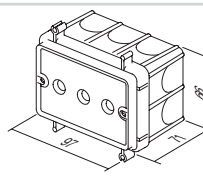
RECTANGULAR BOX HOLLOW WALL VM72

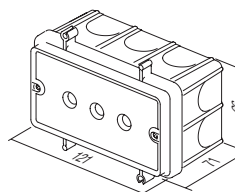
- size 2x7M, depth 63mm
- 850°C, 400V~
- in accordance with IEC 60670-1
- halogen free

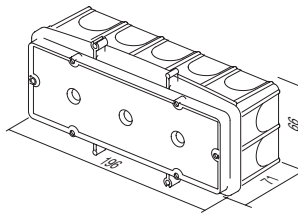

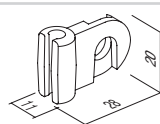
R E C T A N G U L A R B O X E S

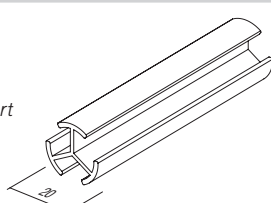
	BM30	OBDĹŽNIKOVÁ KRABICA – BETÓN BM3 - veľkosť 3M, hĺbka 60 mm - 650 °C, 400 V ~ - v súlade s normou IEC 60670-1 - bezhalogénová	
	BM40	OBDĹŽNIKOVÁ KRABICA – BETÓN BM4 - veľkosť 4M, hĺbka 60 mm - 650 °C, 400 V ~ - v súlade s normou IEC 60670-1 - bezhalogénová	
	BM70	OBDĹŽNIKOVÁ KRABICA – BETÓN BM7 - veľkosť 7M, hĺbka 60 mm - 650 °C, 400 V ~ - v súlade s normou IEC 60670-1 - bezhalogénová	
	BM80	UPEVNŔOVACÍ PRVOK NA KRABICU BM - pre rýchle upevnenie BM obdĺžnikových skriniek na výstužnú tyč - vhodné pre priemer tyče až Ø 8 mm FIXING COMBI-CLIP BM - for fast fixation of BM rectangular boxes on reinforcing bar - suitable for bar diameter up to Ø8mm	
	BM82	DIŠTANČNÝ PROFIL NA KRABICE BM - na upevnenie krabic BM spolu s montážnym rámkom pre betón do protifahlej steny - dĺžka l = 1 m, priemer Ø 20 mm DISTANCE PROFIL FOR BOXES BM - to support boxes BM with counter box support on opposite wall - length l=1m, diameter Ø20mm	

ROZVODNÉ KRABICE



tehla / brick

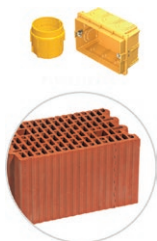

duté priečky / hollow walls

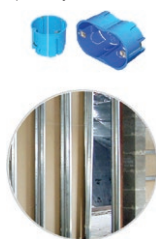

betón / concrete

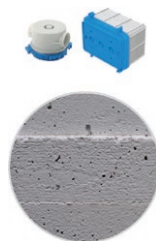

DM30		 NM30	3M
HM30			
BM30			
DM40		 NM40	4M
HM40			
BM40			
DM70		 NM70,75	7M
HM70			
BM70			
DM72		 NM72	2x7M
HM72			
DM30		 NM32	2/3M
HM30			
BM30			

R E C T A N G U L A R B O X E S

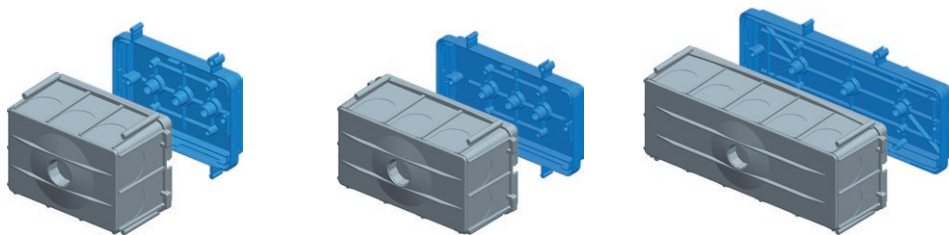

pokyny na montáž /
assembly instructions

1

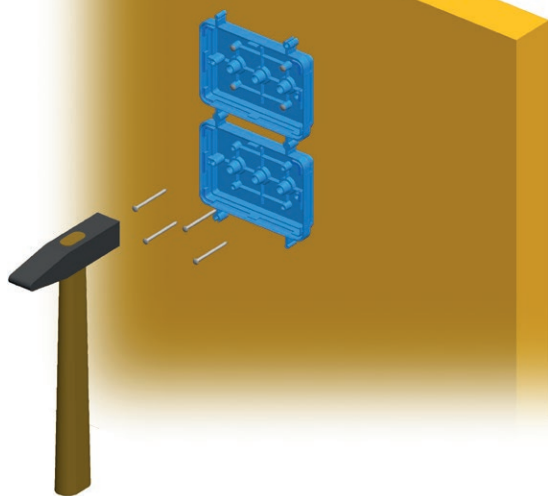

2

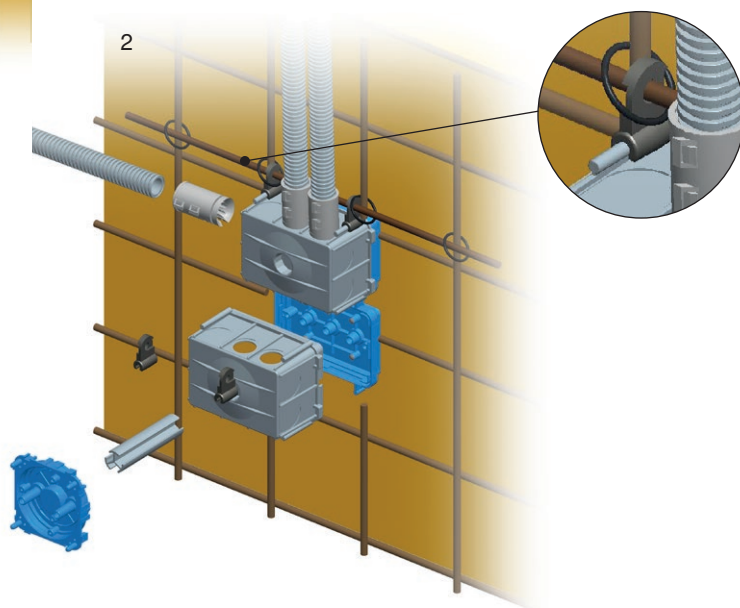

3

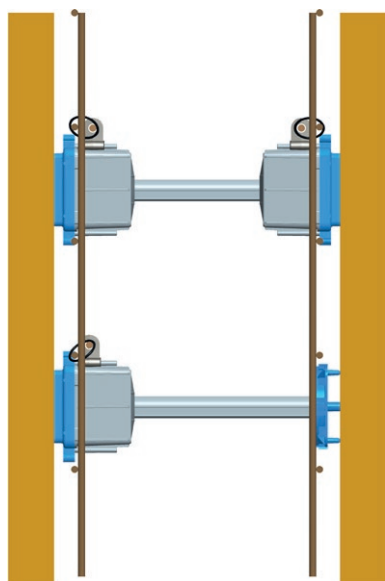

4

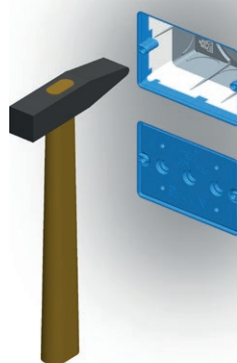

ROZVODNÁ KRABICA OKRÚHLA DO STENY DSM78



DW10

- Ø 78, hĺbka 40 mm
- 650 °C, 500 V ~
- v súlade s normou IEC 60670-1 a IEC 60670-22
- bezhalogénová

CONNECTION ROUND BOX BRICK DSM78

- Ø78, depth 40mm
- 650°C, 500V~
- in accordance with IEC 60670-1 and IEC 60670-22
- halogen free

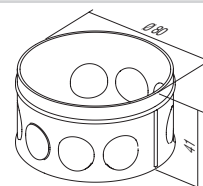

ROZVODNÁ KRABICA OKRÚHLA – DUTÁ PRIEČKA SM78x45



HW10

- Ø 78, hĺbka 45 mm
- vyrezaný otvor Ø80
- 850 °C, 400 V ~
- v súlade s normou IEC 60670-1 a IEC 60670-22
- montáž so svorkami
- bezhalogénová

CONNECTION ROUND BOX HOLLOW WALL SM78x45

- Ø78, depth 45mm
- cutting hole Ø80
- 850°C, 400V~
- in accordance with IEC 60670-1 and IEC 60670-22
- mounting with claws
- halogen free

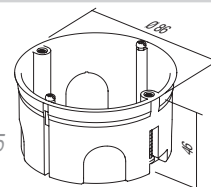

KRYT KRABICE DEKORATÍVNY SM78



DE23

- dekoratívny kryt pre krabice Ø78
- v súlade s normou IEC 60670-1 a IEC 60670-22
- bezhalogénová

BOX COVER DECORATIVE SM78

- decorative cover for boxes Ø78
- in accordance with IEC 60670-1 and IEC 60670-22
- halogen free

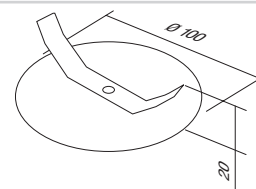

OCHRANNÝ KRYT KRABICE 78



DE24

- ochranný kryt pre krabicu Ø 78
- v súlade s normou IEC 60670-1 a IEC 60670-22
- bezhalogénová

BOX COVER PROTECTIVE 78

- protective cover for box Ø78
- in accordance with IEC 60670-1 and IEC 60670-22
- halogen free

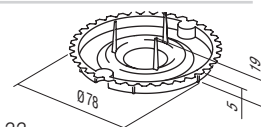

ROZVODNÁ KRABICA ŠTVORCOVÁ DUTÁ PRIEČKA SM105x105



HW20

- veľkosť 105 x 105mm, hĺbka 50 mm
- montážny otvor podľa priloženej šablóny
- 850 °C, 400 V ~
- v súlade s normou IEC 60670-1 a IEC 60670-22
- montáž so svorkami
- bezhalogénová

CONNECTION SQUARE BOX HOLLOW WALL SM105x105

- size 105x105mm, depth 50mm
- cutting hole according to attached template
- 850°C, 400V~
- in accordance with IEC 60670-1 and IEC 60670-22
- mounting with claws
- halogen free

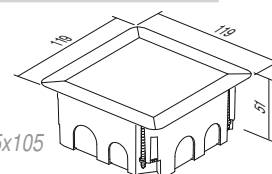

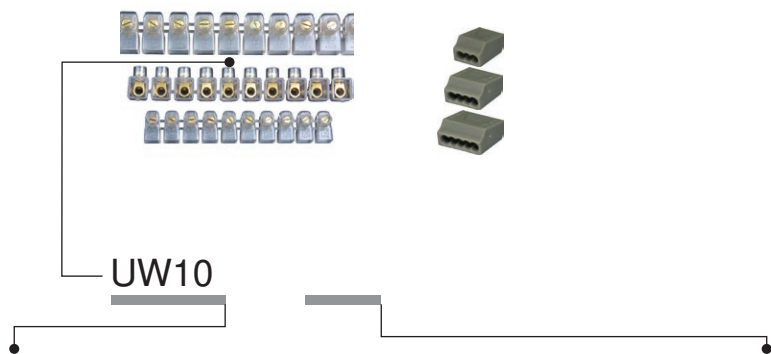

typ type	popis description	technické dáta technical data	veľkosť size	farba colour
UW10	JEDNORADOVÉ SVORKOVNICE 1 ROW TERMINAL BLOCKS	2x2.5mm ²	10P	<input checked="" type="checkbox"/> TS priehľadná transparent
UW11	JEDNORADOVÉ SVORKOVNICE 1 ROW TERMINAL BLOCKS	2x4mm ²	10P	<input type="checkbox"/> CO farba colour
UW12	JEDNORADOVÉ SVORKOVNICE 1 ROW TERMINAL BLOCKS	2x6mm ²	10P	<input type="checkbox"/> WH biela white
·	·	·	·	<input type="checkbox"/> GY sivá grey

JEDNORADOVÉ SVORKOVNICE ZATVORENÉ



- 450 V~; 2 x 2,5 mm² ÷ 2 x 6 mm²
- termoplast PC, priehľadný
- počet pólov: 10

1 ROW TERMINAL BLOCKS CLOSED

- 450V~; 2x2.5mm² ÷ 2x6mm²
- thermoplast PC, transparent
- number of poles: 10

UW10TS	(NS12)	2x2.5mm ²	10P
UW11TS	(NS12)	2x4mm ²	10P
UW12TS	(NS12)	2x6mm ²	10P

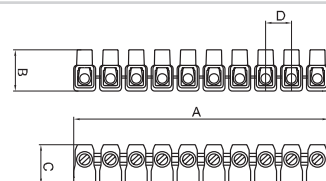

	A	B	C	D
2x2.5 □	110	17.5	17.5	11
2x4 □	128	21	19	12.5
2x6 □	146	21.5	22	15

JEDNORADOVÉ SVORKOVNICE

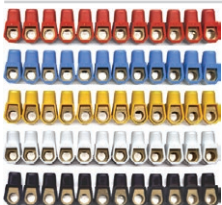

- 450 V~; 2 x 2,5 mm² ÷ 2 x 6 mm²
- termoplast PA
- k dispozícii v rôznych farbách
- počet pólov: 12

1 ROW TERMINAL BLOCKS

- 450V~; 2x2.5mm² ÷ 2x6mm²
- thermoplast PA
- available in different colours
- number of poles: 12

UW15CO	(NS12)	2x2.5mm ²	12P
UW16CO	(NS12)	2x4mm ²	12P
UW17CO	(NS12)	2x6mm ²	12P

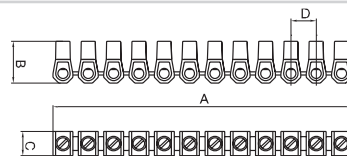

	A	B	C	D
2x2.5 □	110	16.4	9	10
2x4 □	118.8	19	10	10
2x6 □	129.8	21.3	11	11.8

DVOJRADOVÉ SVORKOVNICE PP

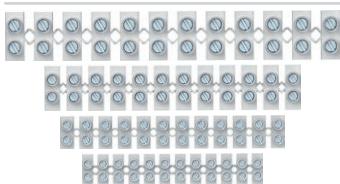

- 450 V~; 1 mm² ÷ 16 mm²
- termoplast polypropylén PP, biely
- pre teploty do 80°C
- počet pólov: 12

2 ROW TERMINAL BLOCKS PP

- 450V~; 1mm² ÷ 16mm²
- thermoplast polypropylene PP, white
- for temperatures up to 80°C
- number of poles: 12



					A	B	C	D	E
UW29WHPP	1.0-4.0mm ²	24 A	450 V		94,9	13	16,6	8,1	6,4
UW30WHPP	1.5-6.0mm ²	32 A	450 V		116,5	14,9	18,9	10	7,3
UW31WHPP	2.5-10mm ²	41 A	450 V		133,8	17,3	23,4	11,5	10
UW32WHPP	4-16mm ²	76 A	450 V		174,5	20,7	25	15	11

DVOJRADOVÉ SVORKOVNICE PA

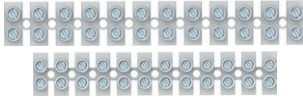

- 450 V~; 1 mm² ÷ 16 mm²
- termoplast polyamid PA, biely
- pre teploty do 110°C
- počet pólov: 12

2 ROW TERMINAL BLOCKS PA

- 450V~; 1mm² ÷ 16mm²
- thermoplast polyamide PA, white
- for temperatures up to 110°C
- number of poles: 12

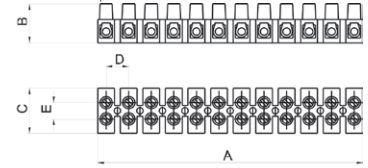

					A	B	C	D	E
UW27WHPA	2.5-10mm ²	41 A	450 V		132,8	17,3	22,2	11,5	10
UW28WHPA	4-16mm ²	76 A	450 V		173,9	20,8	25,2	15	11

BEZSKRUTKOVÉ SVORKY



- 24 A 450 V ~, termoplast PA, sivý
- počet pólov: 3 ÷ 8
- bezskrutkové upevnenie vodičov 0,5 ÷ 1,5 mm², pre tuhé drôty
- v súlade s normou EN 60998-1

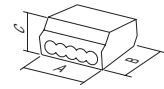

PLUG-IN WIRE CONNECTORS

- 24A 450V~, thermoplast PA, grey
- number of poles: 3÷8
- plug-in contacts 0.5÷1.5mm², for rigide wires
- in accordance with EN 60998-1

UW40GY	PC153	1.5mm ²	3P	3P	A 12	B 18	C 9
UW41GY	PC155	1.5mm ²	5P	5P	17	18	9
UW42GY	PC158	1.5mm ²	8P	8P	26	18	9

BEZSKRUTKOVÉ SVORKY



- 24 A 450 V ~, termoplast PA, sivý
- počet pólov: 3 ÷ 5
- bezskrutkové upevnenie vodičov 1,5 ÷ 2,5 mm², pre tuhé drôty
- v súlade s normou EN 60998-1

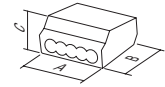

PLUG-IN WIRE CONNECTORS

- 24A 450V~, thermoplast PA, grey
- number of poles: 3÷5
- plug-in contacts 1.5÷2.5mm², for rigide wires
- in accordance with EN 60998-1

UW45GY	PC253	2.5mm ²	3P	3P	A 14	B 19	C 9
UW46GY	PC254	2.5mm ²	4P	4P	17	19	9
UW47GY	PC255	2.5mm ²	5P	5P	21	19	9

BEZSKRUTKOVÁ SVORKA



- 24 A 450 V ~, termoplast PA, sivý
- počet pólov: 2 (tuhy drôt) + 1 (mäkký drôt)
- bezskrutkové upevnenie vodičov 1,5 ÷ 2,5 mm²
- v súlade s normou EN 60998-1

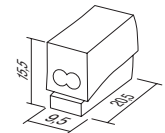

PLUG-IN WIRE CONNECTOR

- 24A 450V~, thermoplast PA, grey
- number of poles: 2 (rigide wire)+1 (soft wire)
- plug-in contacts 1.5÷2.5mm²
- in accordance with EN 60998-1

UW50WH	PC302	2.5mm ²	2/1P				
--------	-------	--------------------	------	--	--	--	--



158



159



161

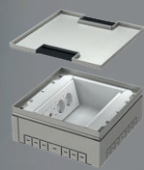

166

DISTRIBÚCIA

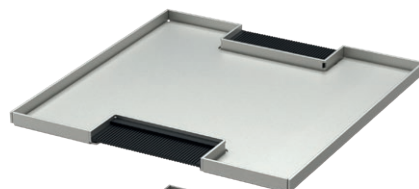

TEM



K R A B I C E C U B O I P 5 5 A Q

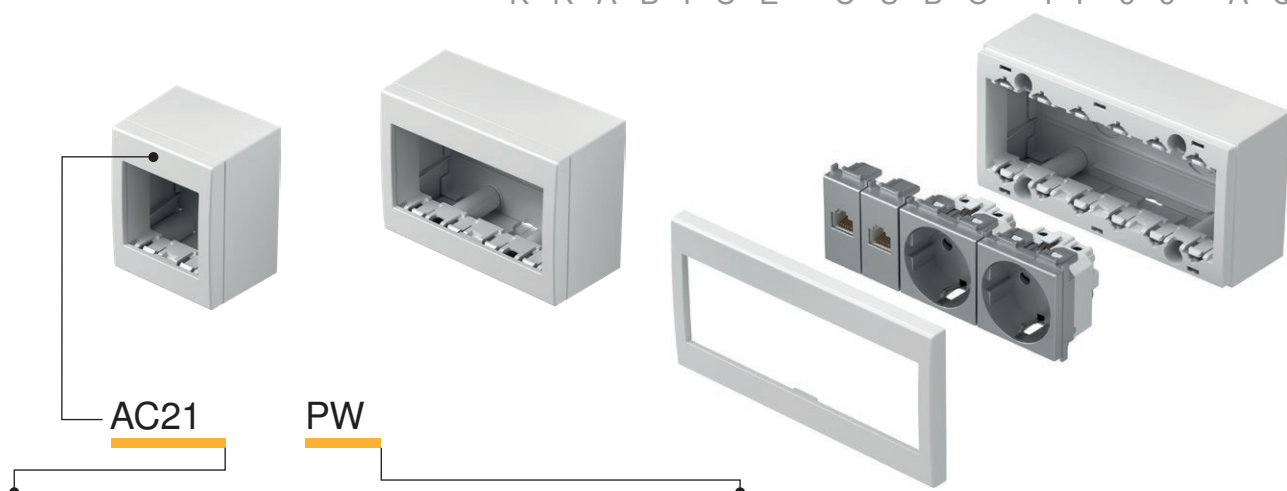

typ type	popis description	technické dáta technical data	veľkosť size	farba colour
AC11	KRABICE PRE POVRCHOVÚ MONTÁŽ S KRYTOM NA ZADNEJ STRANE SURFACE MOUNT BOX WITH BACK SIDE COVER	IP20	1M	<input type="checkbox"/> PW polárna biela polar white <input type="checkbox"/> ES strieborná matná elox silver <input type="checkbox"/> IW slonová kosť ivory white <input type="checkbox"/> AT antracitová anthracite
AC21	KRABICE PRE POVRCHOVÚ MONTÁŽ S KRYTOM NA ZADNEJ STRANE SURFACE MOUNT BOX WITH BACK SIDE COVER	IP20	2M	<input type="checkbox"/> PW polárna biela polar white <input type="checkbox"/> ES strieborná matná elox silver <input type="checkbox"/> IW slonová kosť ivory white <input type="checkbox"/> AT antracitová anthracite
AC41	KRABICE PRE POVRCHOVÚ MONTÁŽ S KRYTOM NA ZADNEJ STRANE SURFACE MOUNT BOX WITH BACK SIDE COVER	IP20	4M	<input type="checkbox"/> PW polárna biela polar white <input type="checkbox"/> ES strieborná matná elox silver <input type="checkbox"/> IW slonová kosť ivory white <input type="checkbox"/> AT antracitová anthracite

KRABICA NO CUBO S KRYTOM ZADNEJ STRANY IP20 1M



- AC11PW
- AC11ES
- AC11IW
- AC11AT

- krabica IP20 1M
- pre povrchovú montáž prvkov
- vhodné pre spínače SM
- v súlade s normou EN 60669-1

BOX NO CUBO WITH BACK SIDE COVER IP20 1M
- box IP20 1M
- for surface mounting of elements
- suitable to SM switches
- in accordance with EN 60669-1



KRABICA NO CUBO S KRYTOM ZADNEJ STRANY IP20 2M



- AC21PW
- AC21ES
- AC21IW
- AC21AT

- krabica IP20 2M
- pre povrchovú montáž prvkov
- v súlade s normami EN 60669-1, EN60884-1

BOX NO CUBO WITH BACK SIDE COVER IP20 2M
- box IP20 2M
- for surface mounting of elements
- in accordance with EN 60669-1, EN60884-1



KRABICA NO CUBO S KRYTOM ZADNEJ STRANY IP20 4M



- AC41PW
- AC41ES
- AC41IW
- AC41AT

- krabica IP20 4M
- pre povrchovú montáž prvkov
- v súlade s normami EN 60669-1, EN60884-1

BOX NO CUBO WITH BACK SIDE COVER IP20 4M
- box IP20 4M
- for surface mounting of elements
- in accordance with EN 60669-1, EN60884-1



KRABICA NO CUBO S KRYTOM ZADNEJ STRANY IP20 6M



- AC61PW
- AC61ES
- AC61IW
- AC61AT

- krabica IP20 6M
- pre povrchovú montáž prvkov
- v súlade s normami EN 60669-1, EN60884-1

BOX NO CUBO WITH BACK SIDE COVER IP20 6M
- box IP20 6M
- for surface mounting of elements
- in accordance with EN 60669-1, EN60884-1

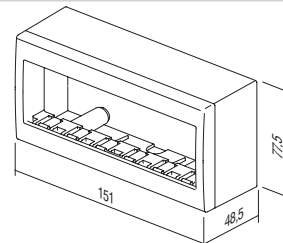
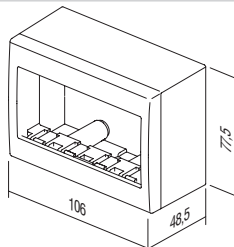
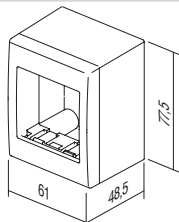
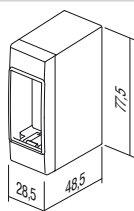

B O X E S C U B O I P 5 5 A Q



typ type	popis description	technické dáta technical data	veľkosť size	farba colour
AQ20	KRABICA URČENÁ PRE POVRCHOVÚ MONTÁŽ DO EXTERIÉRU IP55 <i>OUTDOOR SURFACE MOUNT BOX</i>		2M	<input type="checkbox"/> PW polárna biela <i>polar white</i>
AQ22	KRABICA URČENÁ PRE POVRCHOVÚ MONTÁŽ DO EXTERIÉRU IP55 <i>OUTDOOR SURFACE MOUNT BOX</i>		2x2M	<input checked="" type="checkbox"/> GY sivá <i>grey</i>
AQ30	KRABICA URČENÁ PRE POVRCHOVÚ MONTÁŽ DO EXTERIÉRU IP55 <i>OUTDOOR SURFACE MOUNT BOX</i>		3M	
AQ31	KRABICA URČENÁ PRE POVRCHOVÚ MONTÁŽ DO EXTERIÉRU IP55 <i>OUTDOOR SURFACE MOUNT BOX</i>		3M	

KRABICA NO CUBO IP55 2M



- AQ20PW
 AQ20GY

- krabica IP55 2M
- pre povrchovú montáž
- IP55 pre použitie vo vlhkých oblastiach
- v súlade s normami CEI 23-48, EN 60670

BOX NO CUBO IP55 2M

- box IP55 2M
- for surface mounting
- IP55 for usage in humid areas
- in accordance with CEI 23-48, EN 60670



KRABICA NO CUBO IP55 2x2M



- AQ22PW
 AQ22GY

- krabica IP55 2 x 2M
- pre povrchovú montáž
- IP55 pre použitie vo vlhkých oblastiach
- v súlade s normami CEI 23-48, EN 60670

BOX NO CUBO IP55 2x2M

- box IP55 2x2M
- for surface mounting
- IP55 for usage in humid areas
- in accordance with CEI 23-48, EN 60670



KRABICA NO CUBO IP55 3M



- AQ30PW
 AQ30GY

- krabica IP55 3M
- pre povrchovú montáž
- IP55 pre použitie vo vlhkých oblastiach
- v súlade s normami CEI 23-48, EN 60670

BOX NO CUBO IP55 3M

- box IP55 3M
- for surface mounting
- IP55 for usage in humid areas
- in accordance with CEI 23-48, EN 60670





- AQ21PW
- AQ21AT

KRABICA PO CUBO IP55 2M

- krabica IP55 2M
- môžete ju kombinovať so všetkými funkčnými elementami Modul
- na zapustenú montáž
- IP55 pre montáž do vlhkých priestorov
- v súlade s normami CEI 23-48, EN 60670

BOX PO CUBO IP55 2M

- box IP55 2M
- can be combined with all Modul functional elements
- for flush mounting
- IP55 for usage in humid areas
- in accordance with CEI 23-48, EN 60670



- AQ31PW
- AQ31GY

KRABICA PO CUBO IP55 3M

- krabica IP55 3M
- na zapustenú montáž
- IP55 pre použitie vo vlhkých oblastiach
- v súlade s normami CEI 23-48, EN 60670

BOX PO CUBO IP55 3M

- box IP55 3M
- for flush mounting
- IP55 for usage in humid areas
- in accordance with CEI 23-48, EN 60670

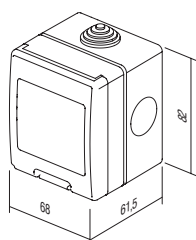

AQ20

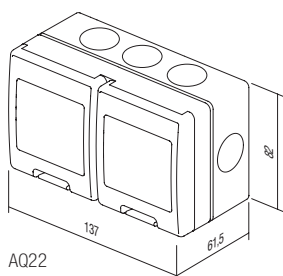

AQ22

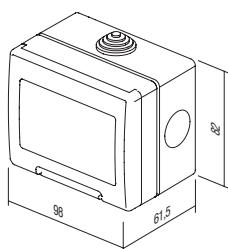

AQ30

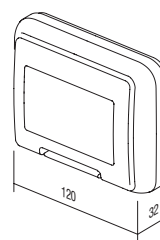

AQ31

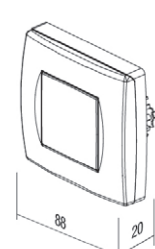

AQ21

TRUNKING SYSTEM ALUMINIUM

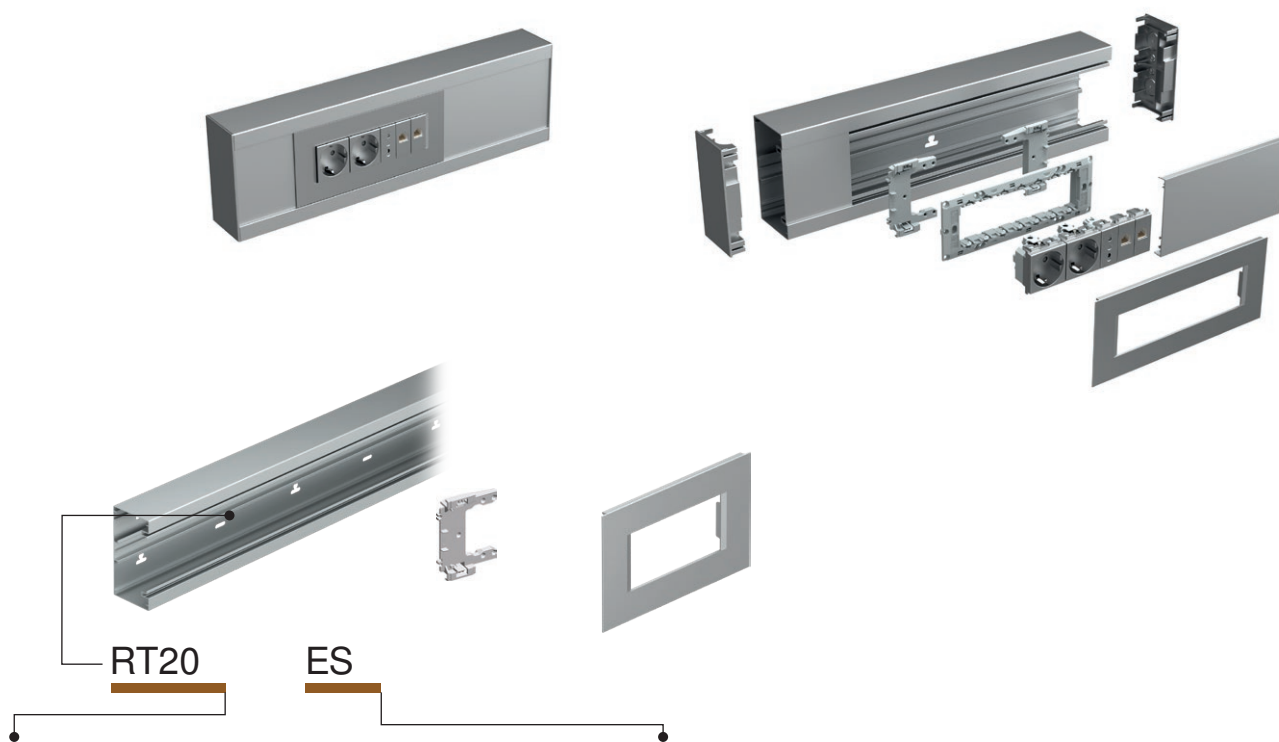

typ type	popis description	veľkosť size	farba colour
RT10	ADAPTÉR MA 92 ADAPTER MA 92	/	■ ES eloxová strieborná – matná elox silver-mat
RT12	RÁMIK MA 92 COVER PLATE MA 92	2/3M	□ PW biela - matná (RAL 9016) white-mat
RT14	RÁMIK MA 92 COVER PLATE MA 92	4M	
⋮	⋮	⋮	

ADAPTÉR MA 92



RT10

- adaptér pre upevnenie montážnych rámov 2/3M, 4M alebo 7M na kanál MA bez krabice
- každý montážny rám vyžaduje dva adaptéry
- v súlade s normou EN 50085-1

ADAPTER MA 92

- adapter for fixing mounting frames 2/3M, 4M or 7M on MA trunking without box
- each mounting frame needs two adapters
- in accordance with EN 50085-1

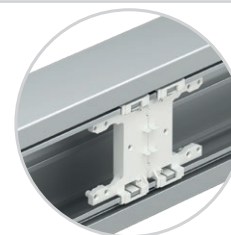

RÁMIK MA 92 2/3M



■ RT12ES
□ RT12PW

- dekoratívny rámik MA 2/3M
- v súlade s normou EN 50085-1

COVER PLATE MA 92 2/3M

- decorative cover plate MA 2/3M
- in accordance with EN 50085-1

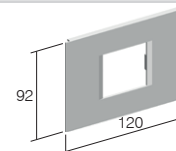

RÁMIK MA 92 4M



■ RT14ES
□ RT14PW

- dekoratívny rámik MA 4M
- v súlade s normou EN 50085-1

COVER PLATE MA 92 4M

- decorative cover plate MA 4M
- in accordance with EN 50085-1

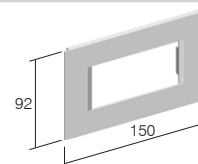

RÁMIK MA 92 7M



■ RT17ES
□ RT17PW

- dekoratívny rámik MA 7M
- v súlade s normou EN 50085-1

COVER PLATE MA 92 7M

- decorative cover plate MA 7M
- in accordance with EN 50085-1

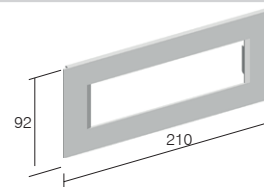

SYSTÉM HLINÍKOVÝCH INŠTALAČNÝCH KANÁLOV

ZÁKLADNÝ PROFIL MA 130x65



- základ kanála z extrudovaného hliníka
- výška 130 mm, dĺžka 2 m
- tvar lišty 35 mm na dne – DIN
- v súlade s normou EN 50085-1

TRUNKING BASE MA 130x65

- trunking base from extruded aluminium
- height 130mm, length 2m
- DIN - rail 35mm shape on bottom
- in accordance with EN 50085-1

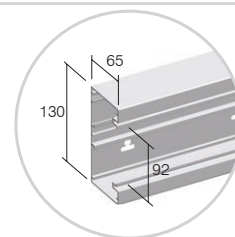

ZÁKLADNÝ PROFIL MA 165x65

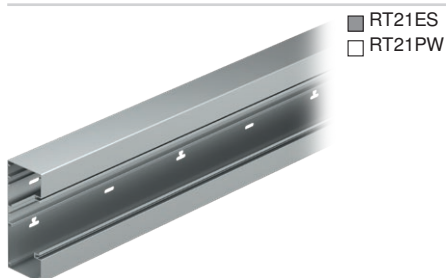

- základ kanála z extrudovaného hliníka
- výška 165 mm, dĺžka 2 m
- tvar lišty 35 mm na dne – DIN
- v súlade s normou EN 50085-1

TRUNKING BASE MA 165x65

- trunking base from extruded aluminium
- height 165mm, length 2m
- DIN - rail 35mm shape on bottom
- in accordance with EN 50085-1

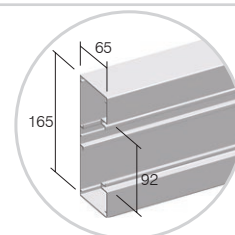

PREDNÝ KRYT MA 92

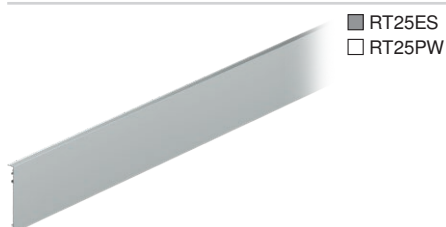

- predný kryt z extrudovaného hliníka
- výška 92 mm, dĺžka 2 m
- v súlade s normou EN 50085-1

FRONT COVER MA 92

- front cover from extruded aluminium
- height 92mm, length 2m
- in accordance with EN 50085-1

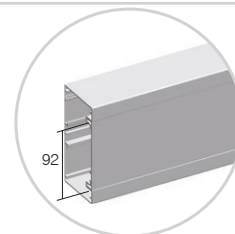

PRIEHRADKA MA 43



- priehradka kanála z extrudovaného polyméru
- hĺbka 43 mm, dĺžka 2 m
- v súlade s normou EN 50085-1

CABLE SHELF MA 43

- cable shelf from extruded polymer
- depth 43mm, length 2m
- in accordance with EN 50085-1

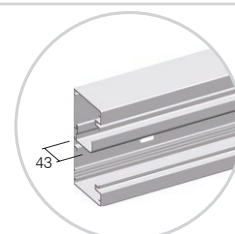

PRIEHRADKA MA 43 AL



- priehradka kanála z extrudovaného hliníka
- hĺbka 43 mm, dĺžka 2 m
- v súlade s normou EN 50085-1

CABLE SHELF MA 43 AL

- cable shelf from extruded aluminium
- depth 43mm, length 2m
- in accordance with EN 50085-1

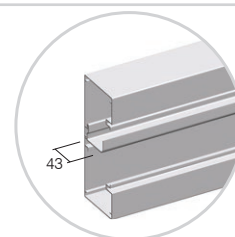

PRIEHRADKA MA 43 AL DVOJITÁ



- dvojité priehradka kanála z extrudovaného hliníka
- hĺbka 43 mm, dĺžka 2 m
- v súlade s normou EN 50085-1

CABLE SHELF MA 43 AL DOUBLE

- double cable shelf from extruded aluminium
- depth 43mm, length 2m
- in accordance with EN 50085-1

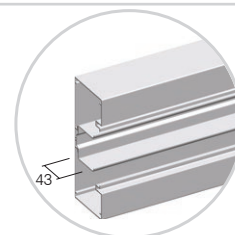

T R U N K I N G S Y S T E M A L U M I N I U M

KONCOVÝ PRVOK MA 130x65



- RT35ES
- RT35PW

- koncový prvok z polyméru
- výška 130 mm
- v súlade s normou EN 50085-1

STOP END MA 130x65

- stop end element from polymer
- height 130mm
- in accordance with EN 50085-1

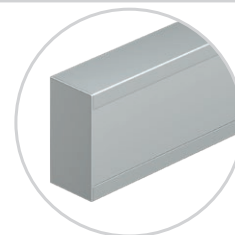

KONCOVÝ PRVOK MA 165x65



- RT36ES
- RT36PW

- koncový prvok z kovu
- výška 165 mm
- v súlade s normou EN 50085-1

STOP END MA 165x65

- stop end element from metal
- height 165mm
- in accordance with EN 50085-1

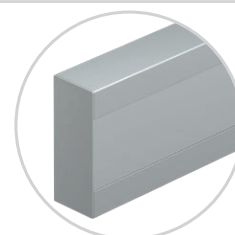

SÚPRAVA SPOJOVACÍCH PRVKOV MA 65



RT38

- spojovací prvok z polyméru
- súprava obsahuje dva kusy a skrutky
- v súlade s normou EN 50085-1

SET JOINING PIECE MA 65

- joining piece from polymer
- set contains two pieces and screws
- in accordance with EN 50085-1

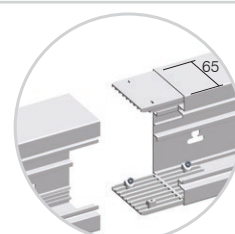

UNIVERZÁLNY ROH MA 130x65



- RT40ES
- RT40PW

- univerzálny rohový prvok
- výška 130 mm
- v súlade s normou EN 50085-1

UNIVERSAL CORNER MA 130x65

- universal corner element
- height 130mm
- in accordance with EN 50085-1

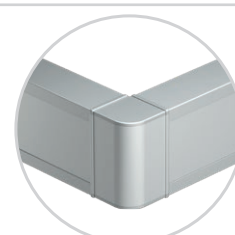

UNIVERZÁLNY ROH MA 165x65



- RT41ES
- RT41PW

- univerzálny rohový prvok
- výška 165 mm
- v súlade s normou EN 50085-1

UNIVERSAL CORNER MA 165x65

- universal corner element
- height 165mm
- in accordance with EN 50085-1

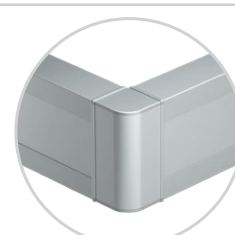

UZEMŇOVACIA SVORKA MA 2x A6.3



RT42

- uzemňovací prvok pre uzemnenie spodného diela kanála a predného krytu
- v súlade s normou EN 50085-1

EARTHING PIECE MA 2x A6.3

- earthing piece for earthing of trunking base and front cover
- in accordance with EN 50085-1

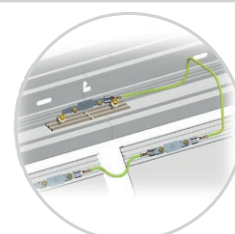

PRVOK V TVARE "L" MA 130x65 / 130



- RT43ES
- RT43PW

- univerzálny ohnutý prvok do tvaru L z hliníka
- výška 130 mm, dĺžka 400 mm
- pripojenie na MA 130 x 65
- v súlade s normou EN 50085-1

L-BEND MA 130x65 / 130

- universal L bend element from aluminium
- height 130mm, length 400mm
- connection on MA 130x65
- in accordance with EN 50085-1

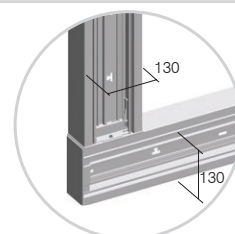

SYSTÉM HLINÍKOVÝCH INŠTALAČNÝCH KANÁLOV

PRVOK V TVARE "L" MA 165x65 / 130



- RT44ES
- RT44PW

- univerzálny ohnutý prvok do tvaru L z hliníka
- výška 165 mm, dĺžka 400 mm
- pripojenie na MA 130 x 65
- v súlade s normou EN 50085-1

L-BEND MA 165x65 / 130

- universal L bend element from aluminium
- height 165mm, length 400mm
- connection on MA 130x65
- in accordance with EN 50085-1

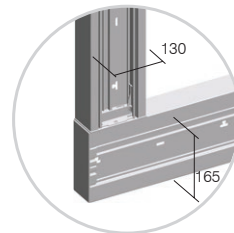

PRVOK V TVARE "L" MA 165x65 / 165



- RT47ES
- RT47PW

- univerzálny ohnutý prvok do tvaru L z hliníka
- výška 165 mm, dĺžka 400 mm
- pripojenie na MA 165 x 65
- v súlade s normou EN 50085-1

L-BEND MA 165x65 / 165

- universal L bend element from aluminium
- height 165mm, length 400mm
- connection on MA 165x65
- in accordance with EN 50085-1

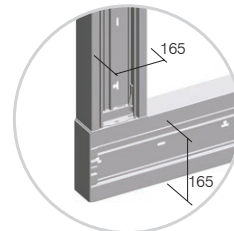

ROZDEĽOVACÍ PRVOK V TVARE "T" MA 130x65 / 130



- RT45ES
- RT45PW

- univerzálny ohnutý prvok do tvaru T z hliníka
- výška 130 mm, dĺžka 400 mm
- pripojenie na MA 130 x 65
- v súlade s normou EN 50085-1

T-BEND MA 130x65 / 130

- universal T bend element from aluminium
- height 130mm, length 400mm
- connection on MA 130x65
- in accordance with EN 50085-1

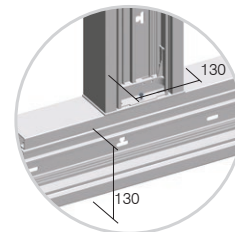

ROZDEĽOVACÍ PRVOK V TVARE "T" MA 165x65 / 130

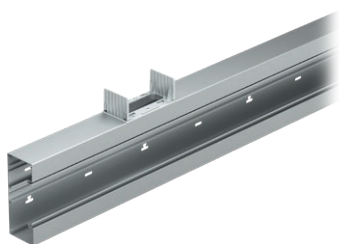

- RT46ES
- RT46PW

- univerzálny ohnutý prvok do tvaru T z hliníka
- výška 165 mm, dĺžka 400 mm
- pripojenie na MA 130 x 65
- v súlade s normou EN 50085-1

T-BEND MA 165x65 / 130

- universal T bend element from aluminium
- height 165mm, length 400mm
- connection on MA 130x65
- in accordance with EN 50085-1

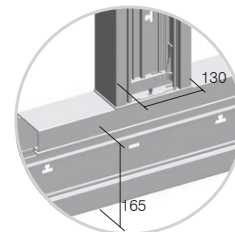

ROZDEĽOVACÍ PRVOK V TVARE "T" MA 165x65 / 165

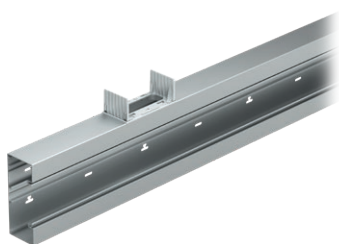

- RT48ES
- RT48PW

- univerzálny ohnutý prvok do tvaru T z hliníka
- výška 165 mm, dĺžka 400 mm
- pripojenie na MA 165 x 65
- v súlade s normou EN 50085-1

T-BEND MA 165x65 / 165

- universal T bend element from aluminium
- height 165mm, length 400mm
- connection on MA 165x65
- in accordance with EN 50085-1

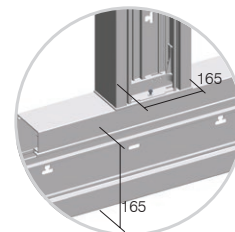

Inštalácia MA je založená na modulárnom systéme, ktorý zabezpečuje kombinácie 2M, 4M alebo 7M prvkov

MA trunking is based on modular system making 2M, 4M or 7M combinations of elements



V Module poskytujeme špeciálne prvky pre rýchlu inštaláciu

In Modul we provide special elements for quick installation

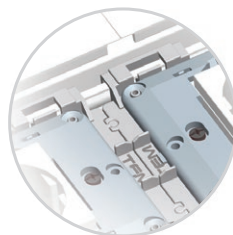

Pomocou adaptéra MA je zabezpečené presné umiestnenie bez ďalšieho úsilia.

With Adapter MA exact positioning without extra effort is provided

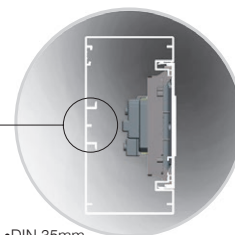

Montáž bez krabice znamená väčší priestor pre káble na DIN lište tvaru EN-60715

Mounted without box means more space for cables, DIN-rail base shape EN-60715

T R U N K I N G S Y S T E M A L U M I N I U M



UPEVNĚVACIA ZÁKLADŇA MA JEDNODUCHÁ 130x65



- RT50ES
- RT50PW

- upevňovacia podstava pre upevnenie spodného diela kanála MA130 do podlahy alebo stropu miestnosti
- v súlade s normou EN 50085-1

FIXING PLATE MA SINGLE 130x65

- fixing plate for fixing trunking base MA130 on the floor and/or on the ceiling
- in accordance with EN 50085-1



- RT51ES
- RT51PW

UPEVNĚVACIA ZÁKLADŇA MA DVOJITÁ 130x65

- upevňovacia podstava pre upevnenie dvoch kanálov MA130 do podlahy alebo stropu miestnosti
- v súlade s normou EN 50085-1

FIXING PLATE MA DOUBLE 130x65

- fixing plate for fixing two trunking bases MA130 on the floor and/or on the ceiling
- in accordance with EN 50085-1



STĽPIK MA 130x65x500

- RT52ES
- RT52PW

- servisný stĺpik MA
- výška 500 mm
- montážny rám 7M je súčasťou dodávky
- v súlade s normou EN 50085-1

SERVICE POST MA 130x65x500

- service post MA
- height 500mm
- mounting frame 7M included
- in accordance with EN 50085-1

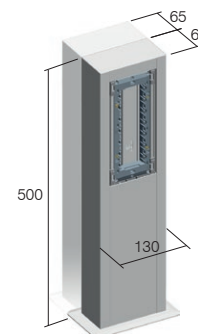

STĽPIK MA DVOJITÝ 130x130x500

- RT53ES
- RT53PW

- servisný stĺpik MA dvojité
- výška 500 mm
- montážne rámy 7M sú súčasťou dodávky
- v súlade s normou EN 50085-1

SERVICE POST MA DOUBLE 130x130x500

- service post MA double
- height 500mm
- mounting frames 7M included
- in accordance with EN 50085-1

Cable intersection mm ²	Použitelný prierez káblov Cable cross-section (mm ²)				
	1 vodič/ 1 wire	2 vodiče/ 2 wires	3 vodiče/ 3 wires	4 vodiče/ 4 wires	5 vodičov/ 5 wires
1,5	44	111	121	144	169
2,5	49	133	157	169	211
4	58	169	183	211	256
6	68	196	225	256	307

Kanál / Trunk	Kapacita kanála / Trunk capacity			
	MA 130x65 prázdny / empty	MA 130x65 so spínačmi a zásuvkami rady Modul / with Modul switches and sockets	MA 165x65 prázdny / empty	MA 130x65 so spínačmi a zásuvkami rady Modul / with Modul switches and sockets
kapacita capacity	7600 mm ²	5500 mm ²	9900 mm ²	7800 mm ²
max ø	54 mm	2x42 mm	54 mm	2x42 mm

PODLAHOVÉ KRABICE MT

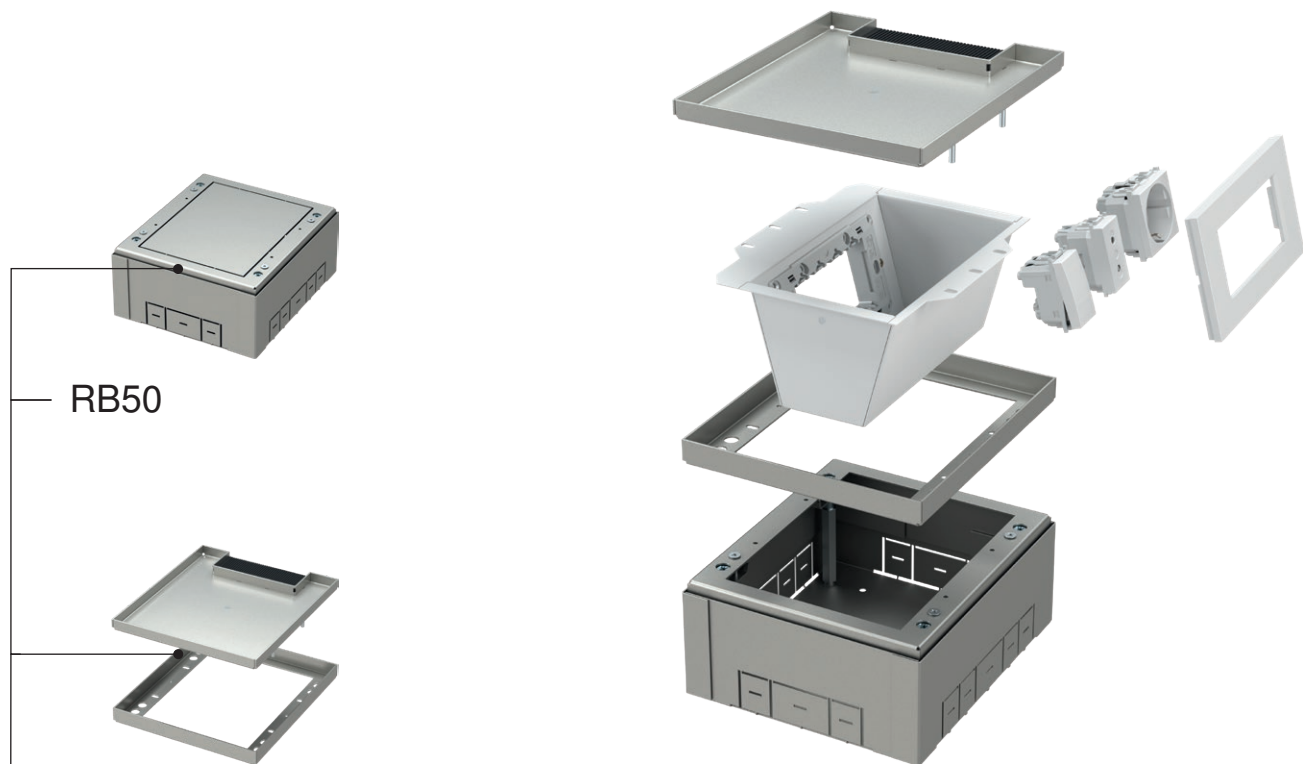

RB50

RB65S1

typ type	popis description	technické dáta technical data
RB50	ZABUDOVATELNÁ PODLAHOVÁ KRABICA FLOOR BOX BASE	4M
RB65S1	KRYT NA PODLAHOVÚ KRABICU FLOOR DISTRIBUTION BOX COVER	4M
RB60	VLOŽKA PRE PODLAHOVÚ KRABICU INSERT FOR FLOOR DISTRIBUTION BOX	4M
·	·	·
·	·	·

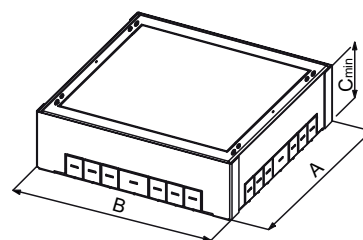
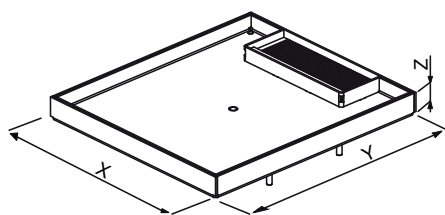

	RB65S1	RB66S1	RB67S2	RB68S2
X	177	178	265	516,5
Y	200,5	265	265	265
Z	17,5	17,5	17,5	17,5

	RB50	RB51	RB52	RB53
A	208,5	273	273	273
B	182	182,5	269,5	521
C min	83	83	83	83

VÝŠKA ZLOŽENIE MIN / MAX
ASSEMBLY HEIGHT MIN / MAX

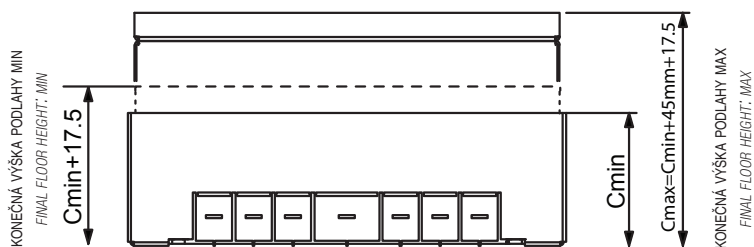

ZABUDOVATEĽNÁ PODLAHOVÁ KRABICA 4M

RB50

- zabudovateľná podlahová krabica 4M
- kovová, pozinkovaná
- pre inštaláciu do podlahy alebo dvojitej podlahy
- montážne rozmery 208,5x182mm, hĺbka min 83mm
- nastaviteľná výška 83-128mm
- v súlade s normami EN 5005-1 a EN 50085-2-2

FLOOR BOX BASE 4M

- floor box base 4M
- metal, galvanized
- for installation in a floor or double floor
- mounting dimensions 208.5x182mm, min. depth 83mm
- adjustable height 83-128mm
- in accordance with EN 5005-1 and EN 50085-2-2

VLOŽKA PRE PODLAHOVÚ KRABICU 4M

RB60

- vložka pre podlahovú krabicu 4M
- kovová, biela farba RAL 9006
- montážny rám MODUL 4M zabudovaný
- v súlade s normami EN 5005-1 a EN 50085-2-2

INSERT FOR FLOOR DISTRIBUTION BOX 4M

- insert for floor box 4M
- metal, colour white RAL 9006
- mounting frame MODUL 4M included
- in accordance with EN 5005-1 and EN 50085-2-2

KRYT NA PODLAHOVÚ KRABICU 4M

RB65S1

- kryt na podlahovú krabicu 4M
- kovový, pozinkovaný
- montážne rozmery 200,5x177mm, hĺbka 17,5mm
- hrúbka podlahovej krytiny do 11,5mm
- v súlade s EN 5005-1 in EN 50085-2-2

FLOOR DISTRIBUTION BOX COVER 4M

- floor box cover 4M
- metal, galvanized
- mounting dimensions 200.5x177mm, depth 17.5mm
- floor thickness up to 11.5mm
- in accordance with EN 5005-1 and EN 50085-2-2

ZABUDOVATEĽNÁ PODLAHOVÁ KRABICA 7M

RB51

- zabudovateľná podlahová krabica 7M
- kovová, pozinkovaná
- pre inštaláciu do podlahy alebo dvojitej podlahy
- montážne rozmery 273x182,5mm, hĺbka min 83mm
- nastaviteľná výška 83-128mm
- v súlade s normami EN 5005-1 a EN 50085-2-2

FLOOR BOX BASE 7M

- floor box base 7M
- metal, galvanized
- for installation in a floor or double floor
- mounting dimensions 273x182.5mm, min. depth 83mm
- adjustable height 83-128mm
- in accordance with EN 5005-1 and EN 50085-2-2

VLOŽKA PRE PODLAHOVÚ KRABICU 7M

RB61

- vložka pre podlahovú krabicu 7M
- kovová, biela farba RAL 9006
- montážny rám MODUL 7M zabudovaný
- v súlade s normami EN 5005-1 a EN 50085-2-2

INSERT FOR FLOOR DISTRIBUTION BOX 7M

- insert for floor box 7M
- metal, colour white RAL 9006
- mounting frame MODUL 7M included
- in accordance with EN 5005-1 and EN 50085-2-2

KRYT NA PODLAHOVÚ KRABICU 7M

RB66S1

- kryt na podlahovú krabicu 7M
- kovový, pozinkovaný
- montážne rozmery 265x178mm, hĺbka 17,5mm
- hrúbka podlahovej krytiny do 11,5mm
- v súlade s EN 5005-1 in EN 50085-2-2

FLOOR DISTRIBUTION BOX COVER 7M

- floor box cover 7M
- metal, galvanized
- mounting dimensions 265x178mm, depth 17.5mm
- floor thickness up to 11.5mm
- in accordance with EN 5005-1 and EN 50085-2-2



RB52

ZABUDOATEĽNÁ PODLAHOVÁ KRABICA 2x7M

- zabudovateľná podlahová krabica 2x7M
 - kovová, pozinkovaná
 - pre inštaláciu do podlahy alebo dvojitej podlahy
 - montážne rozmery 273x269,5mm, hĺbka min 83mm
 - nastaviteľná výška 83-128mm
 - v súlade s normami EN 5005-1 a EN 50085-2-2
- FLOOR BOX BASE 2X7M**
- floor box base 2X7M
 - metal, galvanized
 - for installation in a floor or double floor
 - mounting dimensions 273x269.5mm, min. depth 83mm
 - adjustable height 83-128mm
 - in accordance with EN 5005-1 and EN 50085-2-2



RB62

VLOŽKA PRE PODLAHOVÚ KRABICU 2x7M

- vložka pre podlahovú krabicu 2x7M
 - kovová, biela farba RAL 9006
 - montážny rám MODUL 2x7M zabudovaný
 - V súlade s normami EN 5005-1 a EN 50085-2-2
- INSERT FOR FLOOR DISTRIBUTION BOX 2X7M**
- insert for floor box 2x7M
 - metal, colour white RAL 9006
 - mounting frames MODUL 2x7M included
 - in accordance with EN 5005-1 and EN 50085-2-2

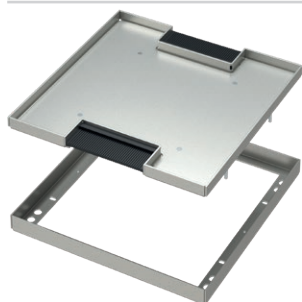

RB67S2

KRYT NA PODLAHOVÚ KRABICU 2X7M

- kryt na podlahovú krabicu 2x7M
 - kovový, pozinkovaný
 - montážne rozmery 265x265mm, hĺbka 17,5mm
 - hrúbka podlahovej krytiny do 11,5mm
 - v súlade s EN 5005-1 in EN 50085-2-2
- FLOOR DISTRIBUTION BOX COVER 2X7M**
- floor box cover 2x7M
 - metal, galvanized
 - mounting dimensions 265x265mm, depth 17.5mm
 - floor thickness up to 11.5mm
 - in accordance with EN 5005-1 and EN 50085-2-2

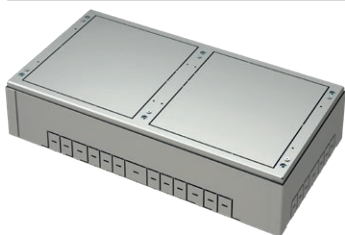

RB53

ZABUDOATEĽNÁ PODLAHOVÁ KRABICA 4x7M

- zabudovateľná podlahová krabica 4x7M
 - kovová, pozinkovaná
 - pre inštaláciu do podlahy alebo dvojitej podlahy
 - montážne rozmery 273x521mm, hĺbka min 83mm
 - nastaviteľná výška 83-128mm
 - v súlade s normami EN 5005-1 a EN 50085-2-2
- FLOOR BOX BASE 4X7M**
- floor box base 4X7M
 - metal, galvanized
 - for installation in a floor or double floor
 - mounting dimensions 273x521mm, min. depth 83mm
 - adjustable height 83-128mm
 - in accordance with EN 5005-1 and EN 50085-2-2



RB62

VLOŽKA PRE PODLAHOVÚ KRABICU 2x7M

- vložka pre podlahovú krabicu 2x7M
 - kovová, biela farba RAL 9006
 - montážny rám MODUL 2x7M zabudovaný
 - V súlade s normami EN 5005-1 a EN 50085-2-2
- INSERT FOR FLOOR DISTRIBUTION BOX 2X7M**
- insert for floor box 2x7M
 - metal, colour white RAL 9006
 - mounting frames MODUL 2x7M included
 - in accordance with EN 5005-1 and EN 50085-2-2



RB68S2

KRYT NA PODLAHOVÚ KRABICU 4x7M

- kryt na podlahovú krabicu 4x7M
 - kovový, pozinkovaný
 - montážne rozmery 265x516,5mm, hĺbka 17,5mm
 - hrúbka podlahovej krytiny do 11,5mm
 - v súlade s EN 5005-1 in EN 50085-2-2
- FLOOR DISTRIBUTION BOX COVER 4X7M**
- floor box cover 4x7M
 - metal, galvanized
 - mounting dimensions 265x516.5mm, depth 17.5mm
 - floor thickness up to 11.5mm
 - in accordance with EN 5005-1 and EN 50085-2-2



RB55S1

typ type	popis description	technické dáta technical data
RB55S1	PODLAHOVÁ KRABICA PRE DVOJITÚ PODLAHU S KRYTOM FLOOR BOX WITH COVER FOR DOUBLE FLOORS	4M
RB60	VLOŽKA PRE PODLAHOVÚ KRABICU INSERT FOR FLOOR DISTRIBUTION BOX	4M
⋮	⋮	⋮
⋮	⋮	⋮

	RB55S1	RB56S1	RB57S2	RB58S2
A	200,5	265	265	265
B	177	178	265	516,5
C min	100	100	100	100

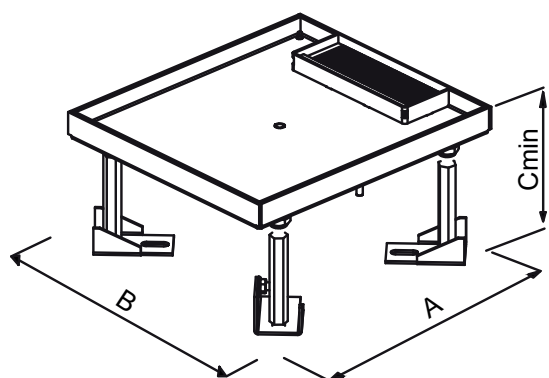
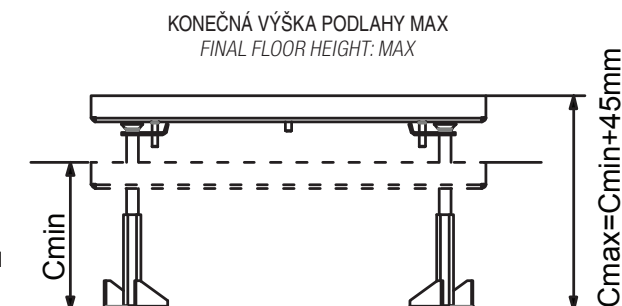
KONEČNÁ VÝŠKA PODLAHY MIN
FINAL FLOOR HEIGHT: MINKONEČNÁ VÝŠKA PODLAHY MAX
FINAL FLOOR HEIGHT: MAX

PODLAHOVÁ KRABICA PRE DVOJITÚ PODLAHU S KRYTOM 4M



RB55S1

- podlahová krabica pre dvojité podlahu 4M
- kovová, pozinkovaná
- montážne rozmery 200,5x177mm, hĺbka min 100mm
- nastaviteľná výška 100-145mm
- hrúbka podlahovej krytiny do 11,5mm
- v súlade s normami EN 5005-1 a EN 50085-2-2

FLOOR BOX WITH COVER FOR DOUBLE FLOORS 4M

- floor box base 4M
- metal, galvanized
- mounting dimensions 200.5x177mm, min. depth 100mm
- adjustable height 100-145mm
- floor thickness up to 11.5mm
- in accordance with EN 5005-1 and EN 50085-2-2

VLOŽKA PRE PODLAHOVÚ KRABICU 4M



RB60

- vložka pre podlahovú krabicu 4M
- kovová, biela farba RAL 9006
- montážny rám MODUL 4M zabudovaný
- v súlade s normami EN 5005-1 a EN 50085-2-2

INSERT FOR FLOOR DISTRIBUTION BOX 4M

- insert for floor box 4M
- metal, colour white RAL 9006
- mounting frame MODUL 4M included
- in accordance with EN 5005-1 and EN 50085-2-2

PODLAHOVÁ KRABICA PRE DVOJITÚ PODLAHU S KRYTOM 7M



RB56S1

- podlahová krabica pre dvojité podlahu 7M
- kovová, pozinkovaná
- montážne rozmery 265x178mm, hĺbka min 100mm
- nastaviteľná výška 100-145mm
- hrúbka podlahovej krytiny do 11,5mm
- v súlade s normami EN 5005-1 a EN 50085-2-2

FLOOR BOX WITH COVER FOR DOUBLE FLOORS 7M

- floor box base 7M
- metal, galvanized
- mounting dimensions 265x178mm, min. depth 100mm
- adjustable height 100-145mm
- floor thickness up to 11.5mm
- in accordance with EN 5005-1 and EN 50085-2-2

VLOŽKA PRE PODLAHOVÚ KRABICU 7M



RB61

- vložka pre podlahovú krabicu 7M
- kovová, biela farba RAL 9006
- montážny rám MODUL 7M zabudovaný
- v súlade s normami EN 5005-1 a EN 50085-2-2

INSERT FOR FLOOR DISTRIBUTION BOX 7M

- insert for floor box 7M
- metal, colour white RAL 9006
- mounting frame MODUL 7M included
- in accordance with EN 5005-1 and EN 50085-2-2

PODLAHOVÁ KRABICA PRE DVOJITÚ PODLAHU S KRYTOM 2x7M



RB57S2

- podlahová krabica pre dvojité podlahu 2x7M
- kovová, pozinkovaná
- montážne rozmery 265x265mm, hĺbka min 100mm
- nastaviteľná výška 100-145mm
- hrúbka podlahovej krytiny do 11,5mm
- v súlade s normami EN 5005-1 a EN 50085-2-2

FLOOR BOX WITH COVER FOR DOUBLE FLOORS 2x7M

- floor box base 2x7M
- metal, galvanized
- mounting dimensions 265x265mm, min. depth 100mm
- adjustable height 100-145mm
- floor thickness up to 11.5mm
- in accordance with EN 5005-1 and EN 50085-2-2

VLOŽKA PRE PODLAHOVÚ KRABICU 2x7M



RB62

- vložka pre podlahovú krabicu 2x7M
- kovová, biela farba RAL 9006
- montážny rám MODUL 2x7M zabudovaný
- v súlade s normami EN 5005-1 a EN 50085-2-2

INSERT FOR FLOOR DISTRIBUTION BOX 2x7M

- insert for floor box 2x7M
- metal, colour white RAL 9006
- mounting frames MODUL 2x7M included
- in accordance with EN 5005-1 and EN 50085-2-2

PODLAHOVÁ KRABICA PRE DVOJITÚ PODLAHU S KRYTOM 4x7M



RB58S2

- podlahová krabica pre dvojité podlahu 4x7M
- kovová, pozinkovaná
- montážne rozmery 265x516,5mm, hĺbka min 100mm
- nastaviteľná výška 100-145mm
- hrúbka podlahovej krytiny do 11,5mm
- v súlade s normami EN 5005-1 a EN 50085-2-2

FLOOR BOX WITH COVER FOR DOUBLE FLOORS 4x7M

- floor box base 4x7M
- metal, galvanized
- mounting dimensions 265x516.5mm, min. depth 100mm
- adjustable height 100-145mm
- floor thickness up to 11.5mm
- in accordance with EN 5005-1 and EN 50085-2-2

VLOŽKA PRE PODLAHOVÚ KRABICU 2x7M

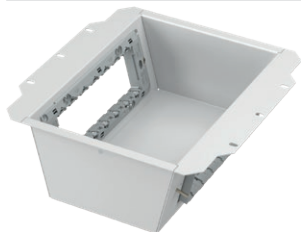

RB62

- vložka pre podlahovú krabicu 2x7M
- kovová, biela farba RAL 9006
- montážny rám MODUL 2x7M zabudovaný
- v súlade s normami EN 5005-1 a EN 50085-2-2

INSERT FOR FLOOR DISTRIBUTION BOX 2x7M

- insert for floor box 2x7M
- metal, colour white RAL 9006
- mounting frames MODUL 2x7M included
- in accordance with EN 5005-1 and EN 50085-2-2

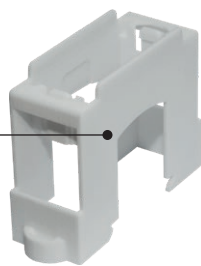
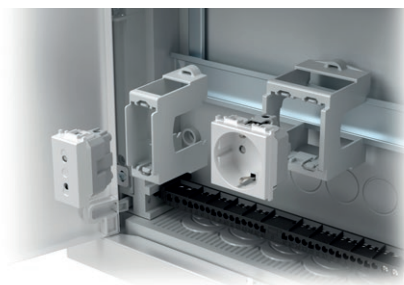
RB10

typ type	popis description	technické dáta technical data
RB10	ADAPTÉR NA DIN LIŠTU ADAPTER FOR DIN RAIL	35mm 1M
RB11	ADAPTÉR NA DIN LIŠTU ADAPTER FOR DIN RAIL	35mm 2M
·	ROZVODNÁ SKRINKA	·
·	·	·
·	·	·

ADAPTÉR NA DIN LIŠTU 35 mm 1M

RB10

- adaptér MODUL 1M
- montáž na DIN lištu 35mm
- v súlade s normou EN 50022

ADAPTER FOR DIN RAIL 35mm 1M

- adapter MODUL 1M
- for DIN rail 35mm
- in accordance with EN 50022

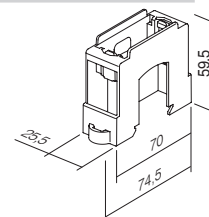

ADAPTÉR NA DIN LIŠTU 35 mm 2M

RB11

- adaptér MODUL 2M
- montáž na DIN lištu 35mm
- v súlade s normou EN 50022

ADAPTER FOR DIN RAIL 35mm 2M

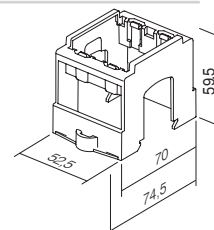
- adapter MODUL 2M
- for DIN rail 35mm
- in accordance with EN 50022



TEM

SWITCH
LOGIQ



LOGIQ

LOGIQ
FLAT



LOGIQ
BOLD



LOGIQ
PRIME



LOGIQ

FLAT



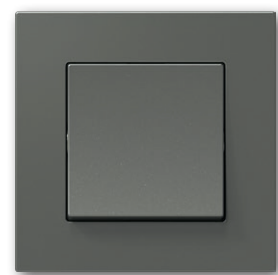

LOGIQ

B O L D





LOGIQ

PRIME



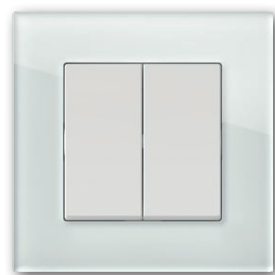

Vyrobené pre akýkoľvek priestor

Univerzálne línie spínačov zanechajú svoju pečať v modernom pracovnom prostredí alebo v útulnejších teplých obytných priestoroch. Rodina spínačov LOGIQ vám ponúka jednoduché a logické riešenie pre každé vaše želanie.

Made for every room

The switches have universal lines that make a mark in both modern work environments and cosy, comfortable living spaces. The LOGIQ family of switches offers a simple and logical solution for your every wish.

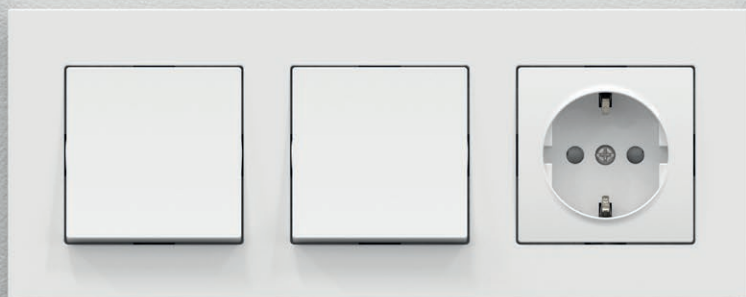

LOGIQ
FLAT



LOGIQ
PRIME

Harmónia farieb pre akýkoľvek priestor

Rodina LOGIQ sa vyznačuje logickým výberom osvedčených a elegantných farebných odtieňov, ktoré používatelia uprednostňujú. Neprispôbujte sa, línia LOGIQ sa prispôbuje vám.

Harmony of colours for every room

The LOGIQ family prides itself on its logical range of verified and elegant hues known and loved by our users. Do not compromise, LOGIQ has you covered.

■ čierna	<i>black</i>
■ antracitová	<i>anthracite</i>
■ titánová	<i>titanium</i>
□ biela lesklá	<i>polar white</i>



LOGIQ
FLAT



LOGIQ
BOLD



LOGIQ
PRIME

Neobmedzená fantázia

Rodina LOGIQ vám umožňuje vytvoriť akúkoľvek kombináciu. Pre jednoduché kombinovanie sme pre vás vytvorili užitočný doplnok, ktorý vám uľahčí zarovnávanie vodorovných a zvislých čiar. Takzvaný systém 55/55 umožňuje použitie rovnakých univerzálnych prvkov.

LIMITLESS IMAGINATION

The LOGIQ family allows you to create your own combinations. To make combining simple, we have created a useful system that supports the sequencing of horizontal and vertical lines. The so-called 55/55 system allows you to use the same universal elements every time.



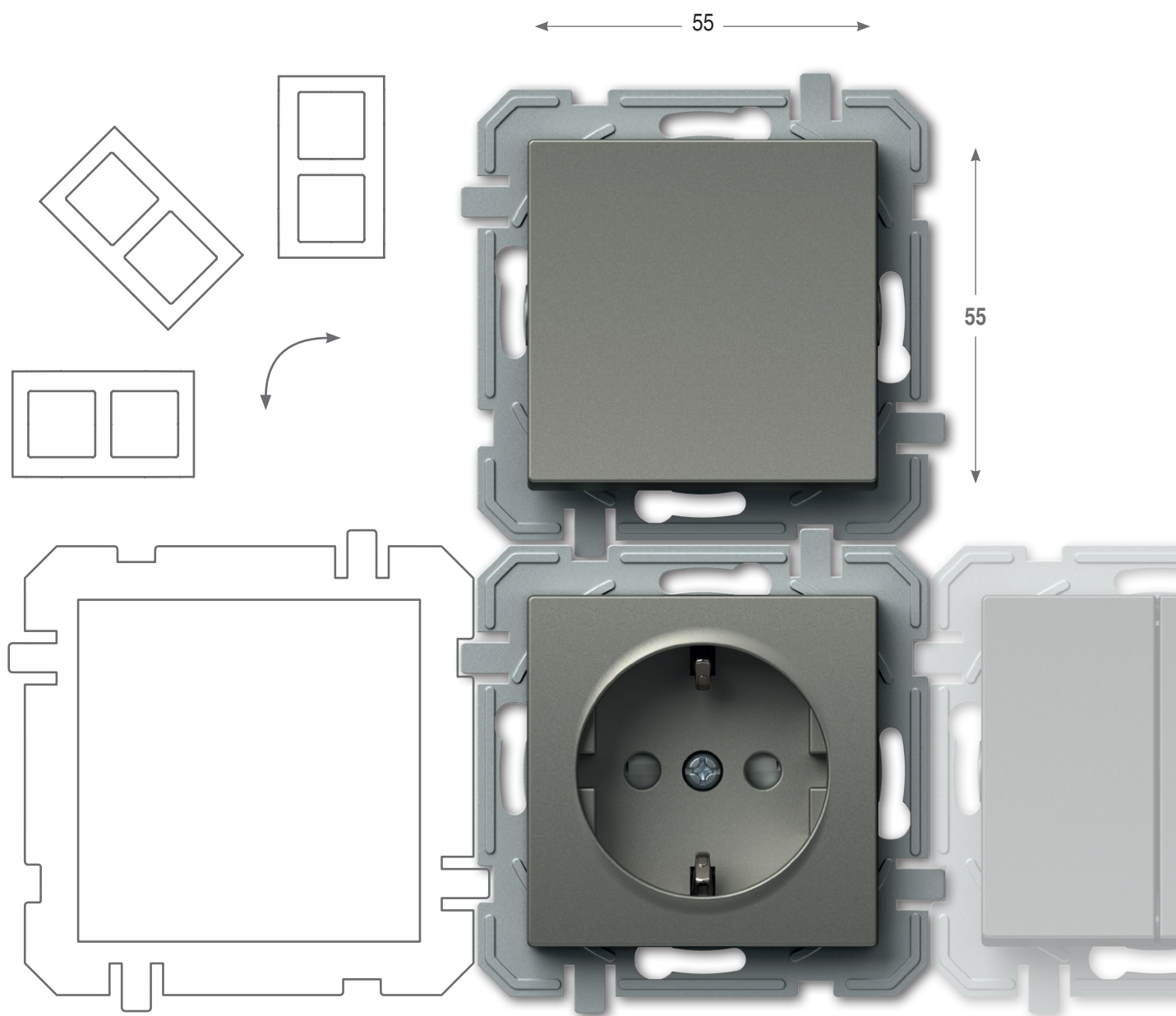

Jednoducho pre najnáročnejších

Rodina LOGIQ ponúka funkčné prvky do každého priestoru a na každý účel. Môžete ich použiť jednotlivo alebo v sérii. Vodorovne alebo zvislo. Logické.

Simple for the most demanding

The LOGIQ family offers functional elements for every space and purpose. You can use these products individually or in a sequence, horizontally or vertically. Logically.

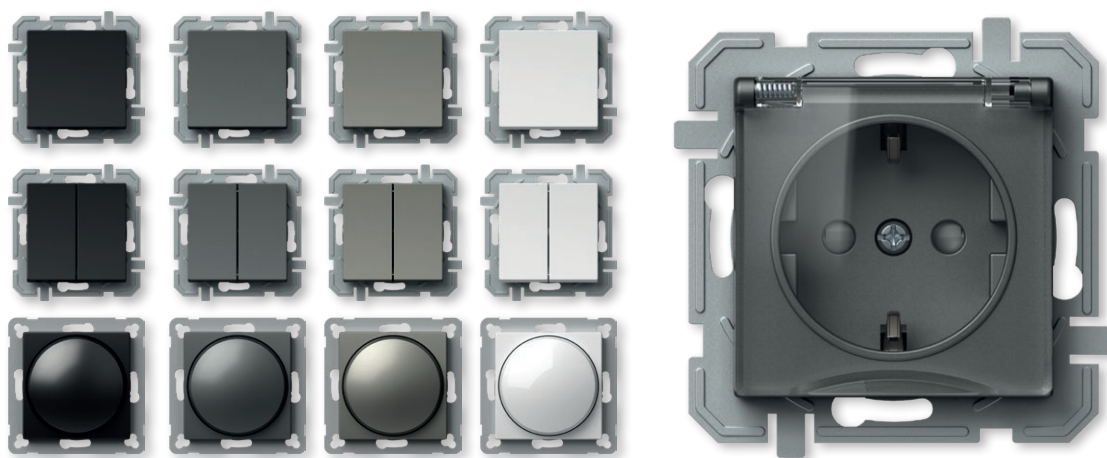

Univerzálne umiestnenie dekoračných rámkov všetkých troch dizajnových radov FLAT, BOLD a PRIME.

A universal layout of decorative cover plates in all three design lines – FLAT, BOLD and PRIME.



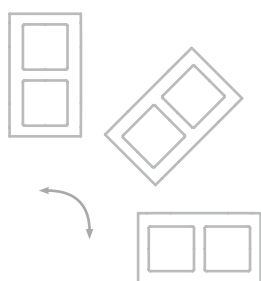

Logická montáž

LOGIQ je riešením pre systém štandardných okrúhlych krabíc. S ním môžete plánovať jednoduché aj zložitejšie inštalácie, novostavby a úpravy. Systém obsahuje bezskrútkové kontakty, ktoré vám šetria čas pri inštalácii prvkov.

Logical installation

LOGIQ is a solution for the system of standardized round installations boxes. It can be used for simple as well as more demanding installations, new buildings and adaptations. The system is characterised by plug-in contacts which save time during installation of elements.

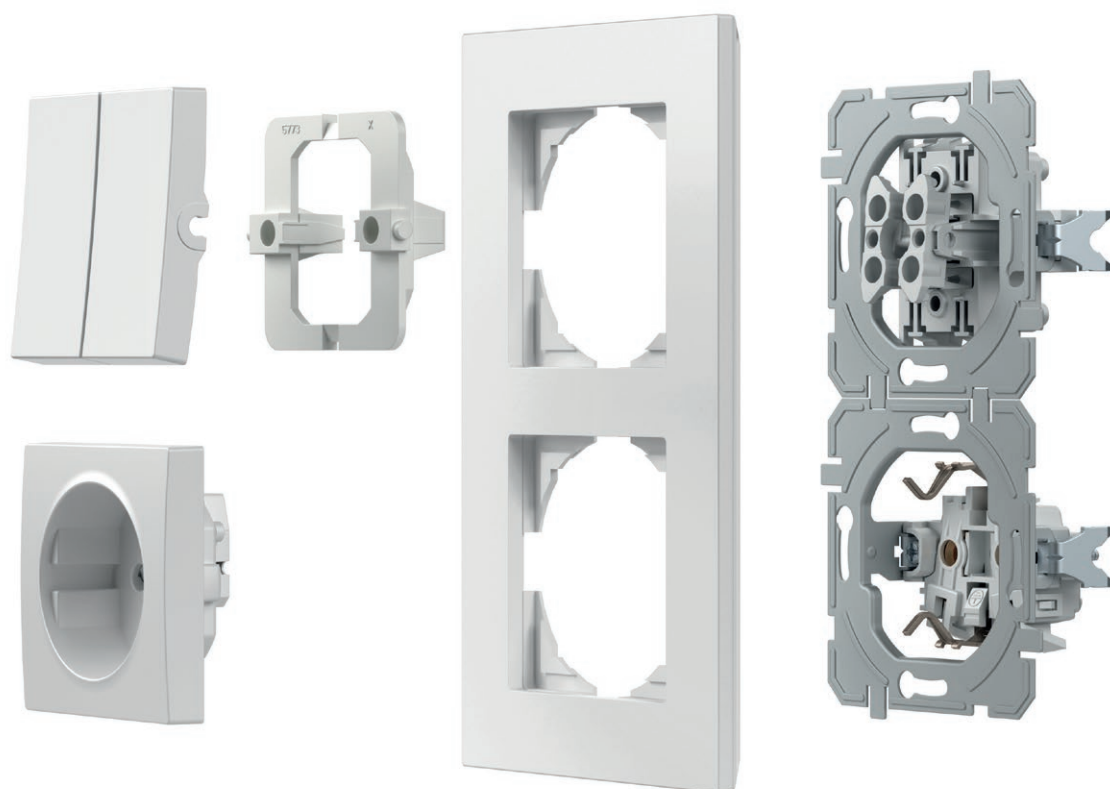

Dobré vedieť

Good to know



Všetky zásuvky sú vybavené bezpečnostnou poistkou zabezpečujúcou ochranu pred dotykcom kontaktov pod napätím.

All the sockets are equipped with a safety shutters assuring the protection to live contacts.



Premyslená konštrukcia spínača umožňuje ľahkú indikáciu aj dodatočne.

The well-thought-out design of the switch enables the easy integration of the indication, including at a later time.



Kontakty zo striebornej zliatiny zaisťujú spoľahlivosť spínania.

Contacts made of silver alloy guarantee safe switching.



Bezskrutkové kontakty umožňujú rýchle a spoľahlivé pripojenie vodičov. Na ten istý kontakt môžete upevniť dva vodiče rôznych priemerov.

Plug-in contacts enable quick and reliable attachment of wires. Two wires of different diameters can be attached to the same contact.



Rozperky umožňujú hlbšie upevnenie (aj cez keramické obkladačky a pod.).

Fixing claws enable deeper fixing (also through ceramic tiles, etc.)







Inštalčné krabice s jednoduchou inštaláciou vám uľahčia prácu. Správne vzdialenosti sú zaručené.

Easy-fitting installation boxes will make your work easier. Proper lengths are guaranteed.



SQ11
PW
IN
01
XO

typ type	názov description	technický popis technical data	farba colour	voliteľný popis 1 optional data 1	voliteľný popis 2 optional data 2	voliteľný popis 3 optional data 3
SQ10	SPÍNAČ JEDNOPÓLOVÝ SWITCH 1WAY	10AX 250V~	<input type="checkbox"/> PW biela lesklá polar white	 NT neutrál neutral	 01	XO bez rámu without cover plate
SQ11	TLAČIDLO JEDNOPÓLOVÉ PUSH BUTTON 1WAY	10A 250V~	<input type="checkbox"/> TI titánová titanium	 IN indikátor indicator	 02	
SQ22	SPÍNAČ DVOJPÓLOVÝ SWITCH 2POLE	16AX 250V~	<input type="checkbox"/> AT antracitová anthracite <input type="checkbox"/> BK čierna black		 03	
...

SPÍNAČ JEDNOPÓLOVÝ 10 AX 250 V~



- SQ10PWXO
- SQ10TIXO
- SQ10ATXO
- SQ10BKXO



- 10 AX 250 V~, typ SQ10
- v súlade s normou EN 60669-1
- bezskrútkové upevnenie vodičov 1,5 – 2,5 mm²
SWITCH 1WAY 10AX 250V~
- 10AX 250V~, type SQ10
- in accordance with EN 60669-1
- plug-in contacts 1.5-2.5mm²



SPÍNAČ JEDNOPÓLOVÝ 10 AX 250 V~



- SQ10PWINXO
- SQ10TIINXO
- SQ10ATINXO
- SQ10BKINXO



- indikátor IN, bez tlejivky
- 10 AX 250 V~, typ SQ10
- v súlade s normou EN 60669-1
- bezskrútkové upevnenie vodičov 1,5 – 2,5 mm²
SWITCH 1WAY 10AX 250V~ __ IN
- IN indicator, without neon lamp
- 10AX 250V~, type SQ10
- in accordance with EN 60669-1
- plug-in contacts 1.5-2.5mm²



TLAČIDLO JEDNOPÓLOVÉ 10 A 250 V~



- SQ11PWXO
- SQ11TIXO
- SQ11ATXO
- SQ11BKXO



- 10 A 250 V~, typ SQ11
- v súlade s normou EN 60669-1
- bezskrútkové upevnenie vodičov 1,5 – 2,5 mm²
PUSH BUTTON 1WAY 10A 250V~
- 10A 250V~, type SQ11
- in accordance with EN 60669-1
- plug-in contacts 1.5-2.5mm²



TLAČIDLO JEDNOPÓLOVÉ 10 A 250 V~ __ IN 01



- SQ11PWIN01XO
- SQ11TIIN01XO
- SQ11ATIN01XO
- SQ11BKIN01XO



- indikátor IN 01 zvonček, bez tlejivky
- 10 A 250 V~, typ SQ11
- v súlade s normou EN 60669-1
- bezskrútkové upevnenie vodičov 1,5 – 2,5 mm²
PUSH BUTTON 1WAY 10A 250V~ __ IN 01
- IN 01 indicator bell, without neon lamp
- 10A 250V~, type SQ11
- in accordance with EN 60669-1
- plug-in contacts 1.5-2.5mm²



TLAČIDLO JEDNOPÓLOVÉ 10 A 250 V~ __ IN 02



- SQ11PWIN02XO
- SQ11TIIN02XO
- SQ11ATIN02XO
- SQ11BKIN02XO

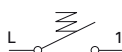

- indikátor IN 02 svetlo, bez tlejivky
- 10 A 250 V~, typ SQ11
- v súlade s normou EN 60669-1
- bezskrútkové upevnenie vodičov 1,5 – 2,5 mm²

PUSH BUTTON 1WAY 10A 250V~ __ IN 02

- IN 02 indicator light, without neon lamp
- 10A 250V~, type SQ11
- in accordance with EN 60669-1
- plug-in contacts 1.5-2.5mm²



TLAČIDLO JEDNOPÓLOVÉ 10 A 250 V~ __ IL



- SQ11PWILXO
- SQ11TIILXO
- SQ11ATILXO
- SQ11BKILXO

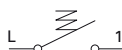

- IL popisný štítok
- 10 A 250 V~, typ SQ11
- v súlade s normou EN 60669-1
- bezskrútkové upevnenie vodičov 1,5 – 2,5 mm²

PUSH BUTTON 1WAY 10A 250V~ __ IL

- IL inscription plate
- 10A 250V~, type SQ11
- in accordance with EN 60669-1
- plug-in contacts 1.5-2.5mm²



TLAČIDLO JEDNOPÓLOVÉ 16 AX 250 V~ __ IN 03



- SQ22PWIN03XO
- SQ22TIIN03XO
- SQ22ATIN03XO
- SQ22BKIN03XO

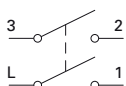

- neutrál IN 03 0-1, bez tlejivky
- 16 AX 250 V~, typ SQ22
- v súlade s normou EN 60669-1
- bezskrútkové upevnenie vodičov 1,5 – 2,5 mm²

SWITCH 2POLE 16AX 250V~ __ IN 03

- IN 03 neutral 0-1, without neon lamp
- 16AX 250V~, type SQ22
- in accordance with EN 60669-1
- screw contacts 1.5-2.5mm²



SPÍNAČ SÉRIOVÝ 10 AX 250 V~



- SQ50PWXO
- SQ50TIXO
- SQ50ATXO
- SQ50BKXO

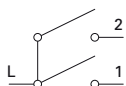

- 10 AX 250 V~, typ SQ50
- v súlade s normou EN 60669-1
- bezskrútkové upevnenie vodičov 1,5 – 2,5 mm²

SWITCH 2GANG-1WAY 10AX 250V~

- 10AX 250V~, type SQ50
- in accordance with EN 60669-1
- plug-in contacts 1.5-2.5mm²



TLAČIDLO SÉRIOVÉ 10 A 250 V~



- SQ51PWXO
- SQ51TIXO
- SQ51ATXO
- SQ51BKXO

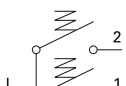

- 10 A 250 V~, typ SQ51
- v súlade s normou EN 60669-1
- bezskrútkové upevnenie vodičov 1,5 – 2,5 mm²

PUSH BUTTON 2GANG-1WAY 10A 250V~

- 10A 250V~, type SQ51
- in accordance with EN 60669-1
- plug-in contacts 1.5-2.5mm²



SPÍNAČ ŽALÚZIOVÝ 10 AX 250 V~ __ NT 09



- SQ52PWNT09XO
- SQ52TINT09XO
- SQ52ATNT09XO
- SQ52BKNT09XO



- NT 09 neutrál hore – dole
- 10 AX 250 V~, typ SQ52
- v súlade s normou EN 60669-1
- bezskrútkové upevnenie vodičov 1,5 – 2,5 mm²
- s mechanickou blokadou súčasného zapnutia

SWITCH SHUTTERS 10AX 250V~ __ NT 09

- NT 09 neutral up-down
- 10AX 250V~, type SQ52
- in accordance with EN 60669-1
- plug-in contacts 1.5-2.5mm²
- with mechanical interblock



TLAČIDLO ŽALÚZIOVÉ 10 A 250 V~ __NT 09



- SQ53PWNT09XO
- SQ53TINT09XO
- SQ53ATNT09XO
- SQ53BKNT09XO

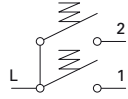

- NT 09 neutrál hore – dole
- 10 A 250 V~, typ SQ53
- v súlade s normou EN 60669-1
- bezskrútkové upevnenie vodičov 1,5 – 2,5 mm²
- s mechanickou blokádou súčasného zapnutia



PUSH BUTTON SHUTTERS 10A 250V~ __ NT 09

- NT 09 neutral up-down
- 10A 250V~, type SQ53
- in accordance with EN 60669-1
- plug-in contacts 1.5-2.5mm²
- with mechanical interlock

SPÍNAČ STRIEDAVÝ 10AX 250V~



- SQ60PWXO
- SQ60TIXO
- SQ60ATXO
- SQ60BKXO

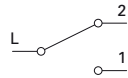

- 10 AX 250 V~, typ SQ60
- v súlade s normou EN 60669-1
- bezskrútkové upevnenie vodičov 1,5 – 2,5 mm²

SWITCH 2WAY 10AX 250V~

- 10AX 250V~, type SQ60
- in accordance with EN 60669-1
- plug-in contacts 1.5-2.5mm²



SPÍNAČ STRIEDAVÝ 10AX 250V~ _IN



- SQ60PWINXO
- SQ60TIINXO
- SQ60ATINXO
- SQ60BKINXO

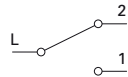

- indikátor IN, bez tlejivky
- 10 AX 250 V~, typ SQ60
- v súlade s normou EN 60669-1
- bezskrútkové upevnenie vodičov 1,5 – 2,5 mm²

SWITCH 2WAY 10AX 250V~ _IN

- IN indicator, without neon lamp
- 10AX 250V~, type SQ60
- in accordance with EN 60669-1
- plug-in contacts 1.5-2.5mm²



SPÍNAČ STRIEDAVÝ 10AX 250V~ _IN 02



- SQ60PWIN02XO
- SQ60TIIN02XO
- SQ60ATIN02XO
- SQ60BKIN02XO

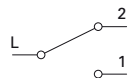

- indikátor IN 02 svetlo, bez tlejivky
- 10 AX 250 V~, typ SQ60
- v súlade s normou EN 60669-1
- bezskrútkové upevnenie vodičov 1,5 – 2,5 mm²

SWITCH 2WAY 10AX 250V~ _IN 02

- IN 02 indicator light, without neon lamp
- 10AX 250V~, type SQ60
- in accordance with EN 60669-1
- plug-in contacts 1.5-2.5mm²



NEW

NEW

SPÍNAČ DVOJITÝ STRIEDAVÝ 10 AX 250 V~



- SQ63PWXO
- SQ63TIXO
- SQ63ATXO
- SQ63BKXO

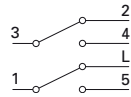

- 10 AX 250 V~, typ SQ63
- v súlade s normou EN 60669-1
- bezskrútkové upevnenie vodičov 1,5 – 2,5 mm²

SWITCH DOUBLE 2WAY 10AX 250V~
 - 10AX 250V~, type SQ63
 - in accordance with EN 60669-1
 - plug-in contacts 1.5-2.5mm²



SPÍNAČ KRÍŽOVÝ 10 AX 250 V~



- SQ70PWXO
- SQ70TIXO
- SQ70ATXO
- SQ70BKXO



- 10 AX 250 V~, typ SQ70
- v súlade s normou EN 60669-1
- bezskrútkové upevnenie vodičov 1,5 – 2,5 mm²

SWITCH INTERMEDIATE 10AX 250V~
 - 10AX 250V~, type SQ70
 - in accordance with EN 60669-1
 - plug-in contacts 1.5-2.5mm²



SQ10
SQ11

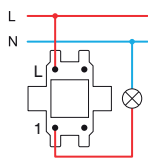

SQ22

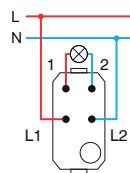

SQ50
SQ51

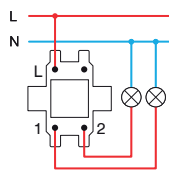

SQ52
SQ53

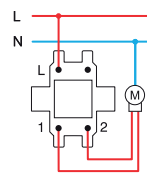

SQ60+SQ60

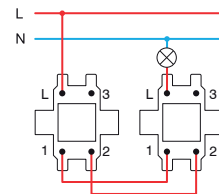

SQ63+SQ63

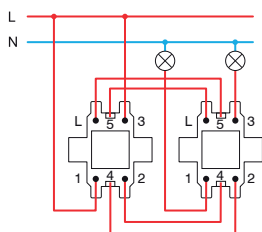

SQ60+SQ70+SQ60

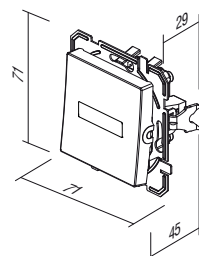
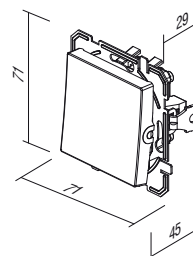
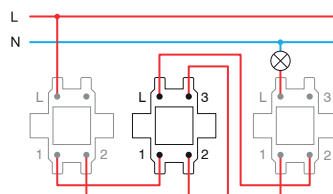

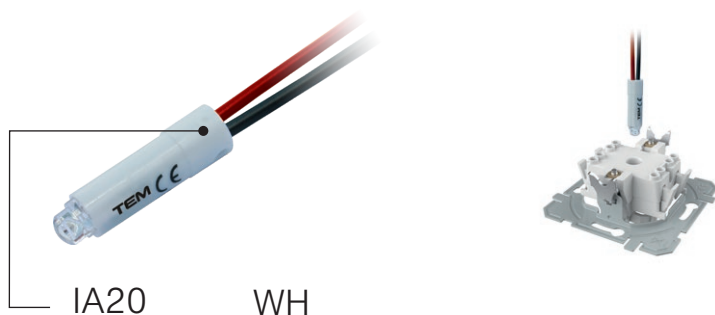

typ type	názov description	technický popis technical data	farba colour
IA10	TLEJIVKA NEON LAMP	230V~ 0,34W	<input type="checkbox"/> WH biela white
IA20	LED SIGNALIZÁCIA LED SIGNALLING UNIT	230V~ 0,40W	<input checked="" type="checkbox"/> BL modrá blue
IA21	LED SIGNALIZÁCIA LED SIGNALLING UNIT	24V AC/DC 0,20W	<input checked="" type="checkbox"/> RD červená red
·	·	·	<input checked="" type="checkbox"/> GR zelená green
·	·	·	<input checked="" type="checkbox"/> OR oranžová orange

TLEJIVKA 230 V~ 0,34 W

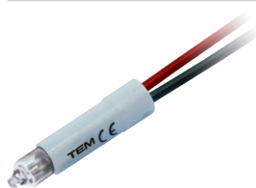

IA10OR

- na indikáciu, signalizáciu alebo trvalú signalizáciu
- v kombinácii s tlačidlom s indikátorom

NEON LAMP 230V~ 0,34W

- for indication, signalling or permanent signalling
- in combination with a button featuring an indicator

LED SIGNALIZÁCIA 230 V AC/DC 0,40 W

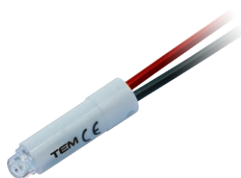

IA20WH
 IA20GR
 IA20RD
 IA20BL

- na indikáciu, signalizáciu alebo trvalú signalizáciu
- v kombinácii s tlačidlom s indikátorom

LED SIGNALLING UNIT 230V AC/DC 0,40W

- for indication, signalling or permanent signalling
- in combination with a button featuring an indicator

LED SIGNALIZÁCIA 24 V AC/DC 0,20 W



IA21WH
 IA21RD

- na indikáciu, signalizáciu alebo trvalú signalizáciu
- v kombinácii s tlačidlom s indikátorom

LED SIGNALLING UNIT 24V AC/DC 0,20W

- for indication, signalling or permanent signalling
- in combination with a button featuring an indicator

LED SIGNALIZÁCIA 12 V AC/DC 0,10 W

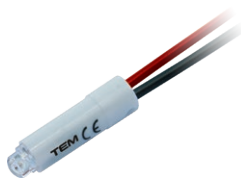

IA22WH
 IA22RD

- na indikáciu, signalizáciu alebo trvalú signalizáciu
- v kombinácii s tlačidlom s indikátorom

LED SIGNALLING UNIT 12V AC/DC 0,10W

- for indication, signalling or permanent signalling
- in combination with a button featuring an indicator

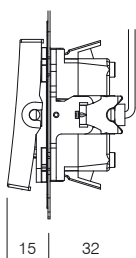

S I G N A L I Z A T I O N I A

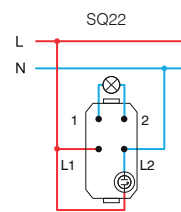
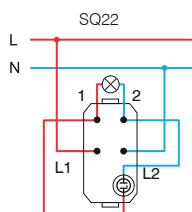
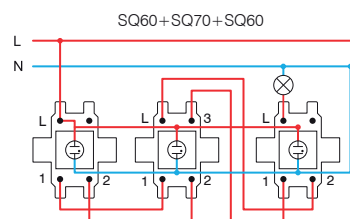
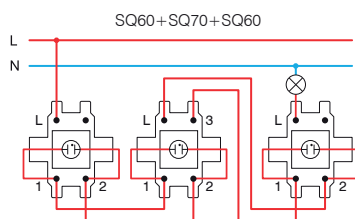
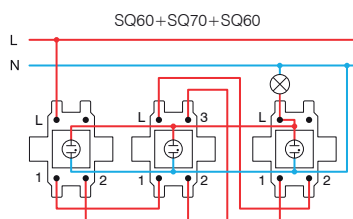
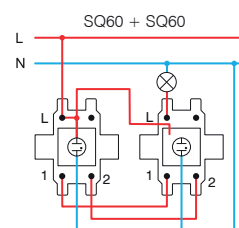
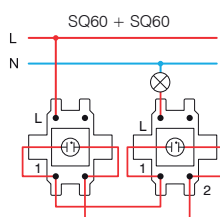
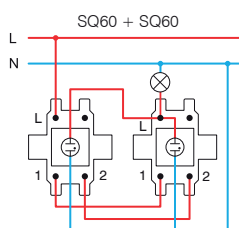
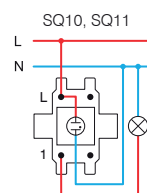
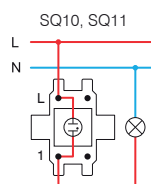
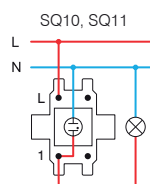
Indikácia/
Indication*Signalizácia/
SignalizationTrvalá signalizácia/
Permanent signalling

* pripojenia nie sú vhodné pre úsporné žiarivky (CFL, LED)
the connections are not suitable for energy-saving bulbs (CFL, LED)

VQ10

PW

XO

typ type	názov description	technický popis technical data	voľiteľný popis 1 optional data 1
VQ10	ZÁSUVKA SCHUKO SOCKET SCHUKO	2P+E 16A 250V~	XO bez rámu without cover plate
VQ11	ZÁSUVKA SCHUKO + KRYT SOCKET SCHUKO+COVER	2P+E 16A 250V~	
VQ12	ZÁSUVKA SCHUKO SOCKET SCHUKO	2P+E 16A 250V~ BV	
⋮	⋮	⋮	
⋮	⋮	⋮	

farba
colour

<input type="checkbox"/> PW	biela lesklá polar white	<input checked="" type="checkbox"/> PT	biela + transparentná white+transparent	<input type="checkbox"/> PP	biela + biela white+white
<input type="checkbox"/> TI	titánová titanium	<input checked="" type="checkbox"/> TT	titán + transparentná titanium+transparent	<input type="checkbox"/> TI	titánová + titánová titanium+titanium
<input type="checkbox"/> AT	antracitová anthracite	<input checked="" type="checkbox"/> AT	antracitová + transparentná anthracite+transparent	<input type="checkbox"/> AA	antracitová + antracitová anthracite+anthracite
<input type="checkbox"/> BK	čierna black	<input checked="" type="checkbox"/> BT	čierna + transparentná black+transparent	<input type="checkbox"/> BB	čierna + čierna black+black
<input type="checkbox"/> RD	červená red	<input checked="" type="checkbox"/> RT	červená + transparentná red+transparent	<input type="checkbox"/> RR	červená + červená red+red
<input type="checkbox"/> GR	zelená green	<input checked="" type="checkbox"/> GT	zelená + transparentná green+transparent	<input type="checkbox"/> GG	zelená + zelená green+green
<input type="checkbox"/> OR	oranžová orange	<input checked="" type="checkbox"/> OT	oranžová + transparentná orange+transparent	<input type="checkbox"/> OO	oranžová + oranžová orange+orange



schuko – v súlade s normou EN 60884-1, CEE7 (list III)

schuko - in accordance with EN 60884-1, CEE7 (standard sheet III)

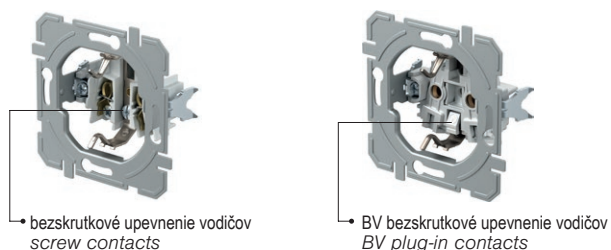

S O C K E T S V Q

ZÁSUVKA SCHUKO 2P + E 16A 250 V~ __ XO

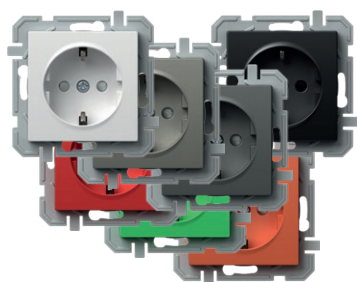

- VQ10PWXO
- VQ10TIXO
- VQ10ATXO
- VQ10BKXO
- VQ10RDXO
- VQ10GRXO
- VQ10ORXO

- skrutkové upevnenie vodičov 1,5 – 2,5 mm²
- XO bez rámu
- 2P + E schuko
- 16 A 250 V~, typ VQ10
- zabudovaná ochrana pred dotykom s kontaktmi



SOCKET SCHUKO 2P+E 16A 250V~ __ XO

- screw contacts 1.5-2.5mm²
- XO without surround
- 2P+E schuko
- 16A 250V~, type VQ10
- shuttered live contacts

ZÁSUVKA SCHUKO + KRYT 2P + E 16 A 250 V~ __ XO

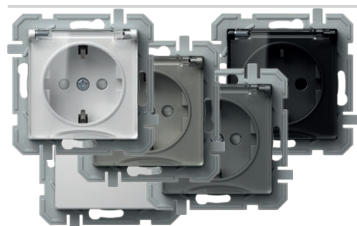

- VQ11PTXO
- VQ11TTXO
- VQ11ATXO
- VQ11BTXO
- VQ11PPXO

- skrutkové upevnenie vodičov 1,5 – 2,5 mm²
- XO bez rámu
- 2P + E schuko + kryt
- 16 A 250 V~, typ VQ11
- zabudovaná ochrana pred dotykom s kontaktmi



SOCKET SCHUKO+COVER 2P+E 16A 250V~ __ XO

- screw contacts 1.5-2.5mm²
- XO without surround
- 2P+E schuko+cover
- 16A 250V~, type VQ11
- shuttered live contacts

ZÁSUVKA SCHUKO 2P + E 16 A 250 V~ __ XO

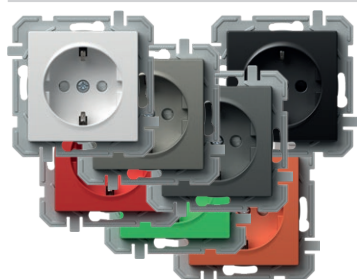

- VQ12PWXO
- VQ12TIXO
- VQ12ATXO
- VQ12BKXO
- VQ12RDXO
- VQ12GRXO
- VQ12ORXO

- bezskrutkové upevnenie vodičov 1,5 – 2,5 mm²
- XO bez rámu
- 2P + E schuko
- 16 A 250 V~, typ VQ12
- zabudovaná ochrana pred dotykom s kontaktmi



SOCKET SCHUKO 2P+E 16A 250V~ BV __ XO

- BV plug-in contacts 1.5-2.5mm²
- XO without surround
- 2P+E schuko
- 16A 250V~, type VQ12
- shuttered live contacts

ZÁSUVKA SCHUKO + KRYT 2P + E 16 A 250 V~ BV __ XO



- VQ13PTXO
- VQ13TTXO
- VQ13ATXO
- VQ13BTXO
- VQ13PPXO

- bezskrutkové upevnenie vodičov 1,5 – 2,5 mm²
- XO bez rámu
- 2P + E schuko + kryt
- 16 A 250 V~, typ VQ13
- zabudovaná ochrana pred dotykom s kontaktmi



SOCKET SCHUKO+COVER 2P+E 16A 250V~ BV __ XO

- BV plug-in contacts 1.5-2.5mm²
- XO without surround
- 2P+E schuko+cover
- 16A 250V~, type VQ13
- shuttered live contacts

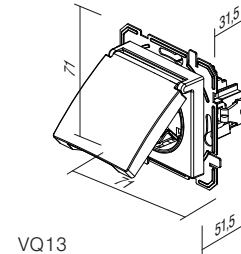
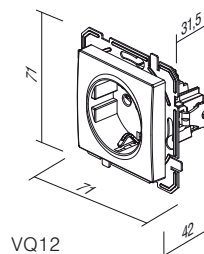
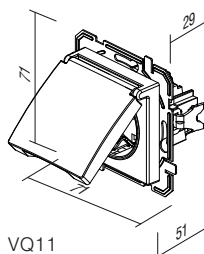
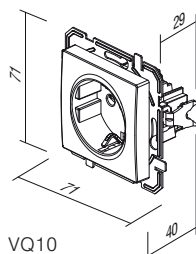

FRANCÚZSKA ZÁSUVKA 2P+E 16 A 250 V ~ __ XO

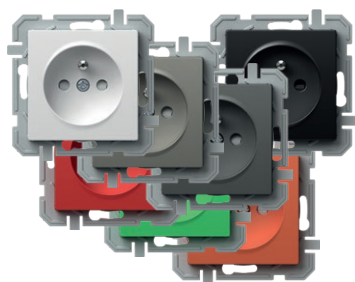

- VQ40PWXO
- VQ40TIXO
- VQ40ATXO
- VQ40BKXO
- VQ40RDXO
- VQ40GRXO
- VQ40ORXO

- skrutkové upevnenie vodičov 1,5 – 2,5 mm²
- XO bez rámečka
- 2P+E francúzska
- 16A 250 V ~, typ VQ40
- zabudovaná ochrana pred dotykcom s kontaktmi pod napätím



SOCKET FRENCH 2P+E 16A 250V~ __ XO

- screw contacts 1.5-2.5mm²
- XO without surround
- 2P+E French
- 16A 250V~, type VQ40
- shuttered live contacts

FRANCÚZSKA ZÁSUVKA + KRYT 2P+E 16 A 250 V ~ __ XO



- ▣ VQ41PTXO
- ▣ VQ41TTXO
- ▣ VQ41ATXO
- ▣ VQ41BTXO
- VQ41PPXO

- skrutkové upevnenie vodičov 1,5 – 2,5 mm²
- XO bez rámečka
- 2P+E francúzska + kryt
- 16A 250 V ~, typ VQ41
- zabudovaná ochrana pred dotykcom s kontaktmi pod napätím



SOCKET FRENCH+COVER 2P+E 16A 250V~ __ XO

- screw contacts 1.5-2.5mm²
- XO without surround
- 2P+E French+cover
- 16A 250V~, type VQ41
- shuttered live contacts

ZÁSUVKA SCHUKO DVOJITÁ 2P + E 16 A 250 V~



- VQ16PWF
- VQ16TIF
- VQ16ATF
- VQ16BKF

- 2P + E schuko dvojité
- 16 A 250 V~, typ VQ16
- v súlade s normou 60884-1, CEE7
- bezskrutkové upevnenie vodičov 1,5 – 2,5 mm²
- zabudovaná ochrana pred dotykcom s kontaktmi



SOCKET SCHUKO DOUBLE 2P+E 16A 250V~

- 2P+E schuko double
- 16A 250V~, type VQ16
- in accordance with IEC 60884-1, CEE7
- screw contacts 1.5-2.5 mm²
- shuttered live contacts

ZÁSUVKA SCHUKO DVOJITÁ 2P + E 16 A 250 V~



- VQ16PW
- VQ16TI
- VQ16AT
- VQ16BK

- 2P + E schuko dvojité
- 16 A 250 V~, typ VQ16
- v súlade s normou 60884-1, CEE7
- bezskrutkové upevnenie vodičov 1,5 – 2,5 mm²
- zabudovaná ochrana pred dotykcom s kontaktmi



SOCKET SCHUKO DOUBLE 2P+E 16A 250V~

- 2P+E schuko double
- 16A 250V~, type VQ16
- in accordance with IEC 60884-1, CEE7
- screw contacts 1.5-2.5 mm²
- shuttered live contacts

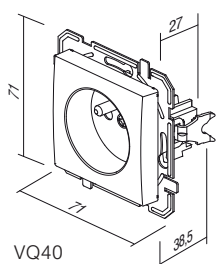

VQ40

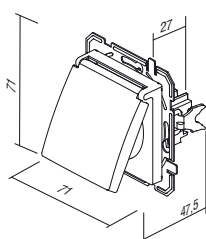

VQ41

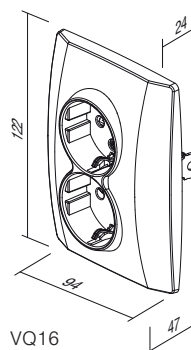

VQ16

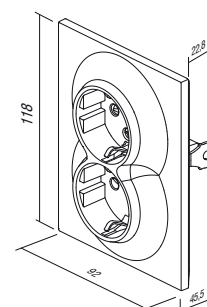

VQ16F

S O C K E T S V Q

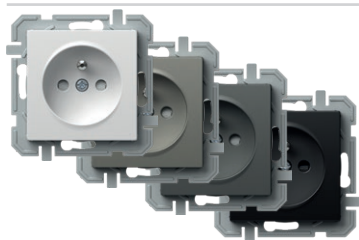

- VQ42PWXO
- VQ42TIXO
- VQ42ATXO
- VQ42BKXO

FRANCÚZSKA ZÁSUVKA 2P+E 16 A 250 V ~ BV __ XO

- BV bezskrutkové upevnenie vodičov 1,5 – 2,5 mm²
- XO bez rámečka
- 2P+E francúzska
- 16A 250 V ~, typ VQ42
- zabudovaná ochrana pred dotykom s kontaktmi pod napätím



SOCKET FRENCH 2P+E 16A 250V~ BV __ XO

- BV plug-in contacts 1.5-2.5mm²
- XO without surround
- 2P+E French
- 16A 250V~, type VQ42
- shuttered live contacts



- VQ43PTXO
- VQ43TTXO
- VQ43ATXO
- VQ43BTXO

- VQ43PPXO

FRANCÚZSKA ZÁSUVKA + KRYT 2P+E 16 A 250 V ~ BV __ XO

- BV bezskrutkové upevnenie vodičov 1,5 – 2,5 mm²
- XO bez rámečka
- 2P+E francúzska + kryt
- 16A 250 V ~, typ VQ43
- zabudovaná ochrana pred dotykom s kontaktmi pod napätím



SOCKET FRENCH+COVER 2P+E 16A 250V~ BV __ XO

- BV plug-in contacts 1.5-2.5mm²
- XO without surround
- 2P+E French+cover
- 16A 250V~, type VQ43
- shuttered live contacts



- VQ46PWF
- VQ46TIF
- VQ46ATF
- VQ46BKF

FRANCÚZSKA ZÁSUVKA DVOJITÁ 2P+E 16 A 250 V ~

- 2P+E francúzska dvojité
- 16A 250 V ~, typ VQ46
- v súlade s normami IEC 60884-1, CEE7, NF C 61-314, ČSN 33 2318 a PN-E 93201
- skrutkové upevnenie vodičov 1,5 – 2,5 mm²
- zabudovaná ochrana pred dotykom s kontaktmi pod napätím



SOCKET FRENCH DOUBLE 2P+E 16A 250V~

- 2P+E French double
- 16A 250V~, type VQ46
- in accordance with IEC 60884-1, CEE7; NF C 61-314, ČSN 33 2318; PN-E 93201
- screw contacts 1.5-2.5 mm²
- shuttered live contacts



- VQ46PW
- VQ46TI
- VQ46AT
- VQ46BK

FRANCÚZSKA ZÁSUVKA DVOJITÁ 2P+E 16 A 250 V ~

- 2P+E francúzska dvojité
- 16A 250 V ~, typ VQ46
- v súlade s normami IEC 60884-1, CEE7, NF C 61-314, ČSN 33 2318 a PN-E 93201
- skrutkové upevnenie vodičov 1,5 – 2,5 mm²
- zabudovaná ochrana pred dotykom s kontaktmi pod napätím



SOCKET FRENCH DOUBLE 2P+E 16A 250V~

- 2P+E French double
- 16A 250V~, type VQ46
- in accordance with IEC 60884-1, CEE7; NF C 61-314, ČSN 33 2318; PN-E 93201
- screw contacts 1.5-2.5 mm²
- shuttered live contacts

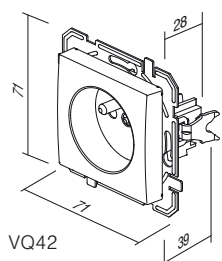

VQ42

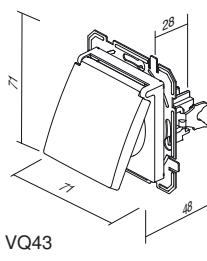

VQ43

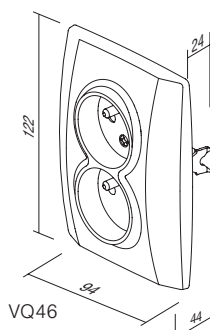

VQ46

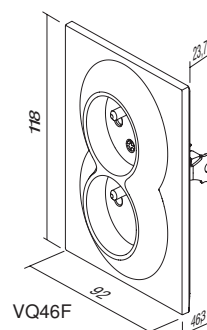

VQ46F

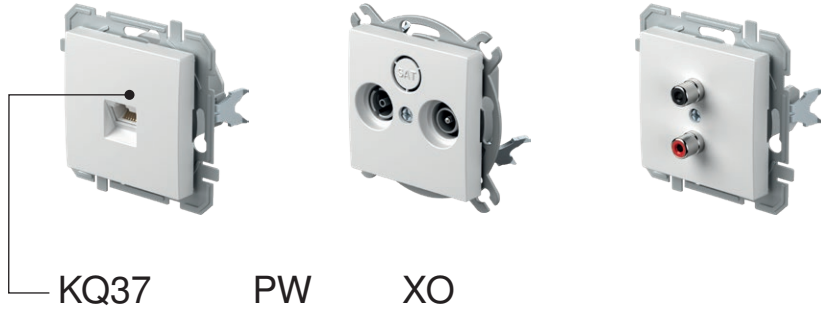

typ type	názov description	technický popis technical data	farba colour	voliteľný popis 1 optional data 1
KQ11	ZÁSUVKA TV-R KONCOVÁ SOCKET TV-R END-LINE	1dB	<input type="checkbox"/> PW biela lesklá polar white	XO bez rámu without cover plate
KQ12	ZÁSUVKA TV-R PRIEBEŽNÁ SOCKET TV-R THROUGHPASS	10dB	<input type="checkbox"/> TI titánová titanium	
KQ16	ZÁSUVKA SAT-TV-R KONCOVÁ SOCKET SAT-TV-R END-LINE	3dB	<input type="checkbox"/> AT antracitová anthracite	
⋮	⋮	⋮	<input type="checkbox"/> BK čierna black	

ZÁSUVKA TV ZÁKLADNÁ 0 dB



- KQ10PWXO
- KQ10TIXO
- KQ10ATXO
- KQ10BKXO

- TV základná
- útlm 0 dB
- zadný konektor – F štandard
SOCKET TV BASIC 0dB
- TV basic
- reduction 0dB
- back connector – F standard



ZÁSUVKA TV-R KONCOVÁ 1 dB

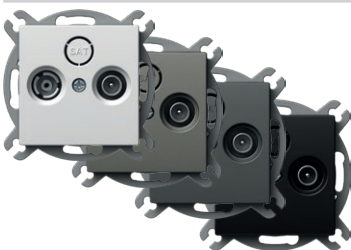

- KQ11PWXO
- KQ11TIXO
- KQ11ATXO
- KQ11BKXO

- TV-R koncová
- frekvenčné pásmo 5÷862 MHz
- útlm: R-1,5dB, TV-1 dB
- v súlade s normou EN 50083-1
- skrutkové upevnenie
SOCKET TV-R END-LINE 1dB
- TV-R end-line
- frequency range 5÷862 MHz
- reduction: R-1.5dB, TV-1dB
- in accordance with EN 50083-1
- screw contact

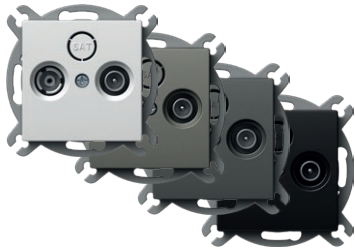

ZÁSUVKA TV-R PRIEBEŽNÁ 10 dB

- KQ12PWXO
- KQ12TIXO
- KQ12ATXO
- KQ12BKXO

- TV-R priebežná
- frekvenčné pásmo 5÷862 MHz
- útlm: R-10dB, TV-10dB, prechod - 2 dB
- v súlade s normou EN 50083-1
- skrutkové upevnenie

SOCKET TV-R TROUGH-PASS 10dB

- TV-R troughpass
- frequency range 5÷862 MHz
- reduction: R-10dB, TV-10dB, trough-2dB
- in accordance with EN 50083-1
- screw contacts

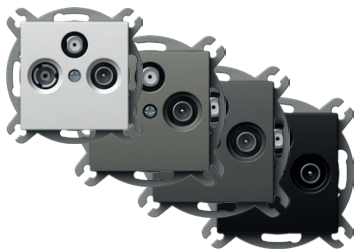
**ZÁSUVKA SAT-TV-R KONCOVÁ 3 dB**

- KQ16PWXO
- KQ16TIXO
- KQ16ATXO
- KQ16BKXO

- SAT-TV-R koncová
- frekvenčné pásmo 5÷2400 MHz
- útlm: R-1dB, TV-1,5dB, SAT - 3 dB
- v súlade s normou EN 50083-1
- skrutkové upevnenie

SOCKET SAT-TV-R END-LINE 3dB

- SAT-TV-R end-line
- frequency range 5÷2400 MHz
- reduction: R-1dB, TV-1.5dB, SAT-3dB
- in accordance with EN 50083-1
- screw contacts

**ZÁSUVKA AUDIO 2 x RCA**

- KQ22PWXO
- KQ22TIXO
- KQ22ATXO
- KQ22BKXO

- audio 2 x RCA
- upevnenie vodičov spájkovaním

SOCKET AUDIO 2xRCA

- audio 2xRCA
- soldering connection of cable



ZÁSUVKA AUDIO REPRODUKTOROVÁ



- KQ23PWXO
- KQ23TIXO
- KQ23ATXO
- KQ23BKXO

- audio 2 x Ø 4 mm
- na pripojenie reproduktorového vodiča, banánovej zástrčky Ø 4 mm alebo vidlicovej káblovej pátky
- upevnenie vodičov vzadu spájkovaním

SOCKET AUDIO LOUDSPEAKERS

- audio 2x Ø4mm
- to accommodate speaker wire, banana plug Ø4mm or spades
- soldering connection of cable at the back side



ZÁSUVKA TEL KS RJ11 6/4



- KQ36PWXO
- KQ36TIXO
- KQ36ATXO
- KQ36BKXO

- KS keystone štandard upevnenia
- RJ11 6/4
- v súlade s normou 60603-7

SOCKET TEL KS RJ11 6/4

- KS keystone fixing standard
- RJ11 6/4
- in accordance with IEC 60603-7



ZÁSUVKA CAT5e KS RJ45 8/8

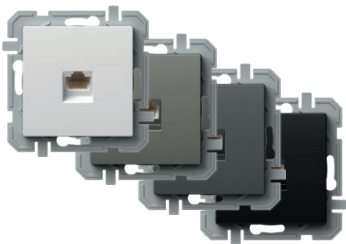

- KQ37PWXO
- KQ37TIXO
- KQ37ATXO
- KQ37BKXO

- KS keystone štandard upevnenia
- CAT5e, RJ45 8/8
- v súlade s normou 60603-7

SOCKET CAT5e KS RJ45 8/8

- KS keystone fixing standard
- CAT5e, RJ45 8/8
- in accordance with IEC 60603-7



ZÁSUVKA TEL KS DVOJITÁ 2 x RJ11 6/4



- KQ38PWXO
- KQ38TIXO
- KQ38ATXO
- KQ38BKXO

- KS keystone štandard upevnenia
- 2 x RJ11, 6/4
- v súlade s normou 60603-7

SOCKET TEL KS DOUBLE 2x RJ11 6/4

- KS keystone fixing standard
- 2x RJ11, 6/4
- in accordance with IEC 60603-7



ZÁSUVKA CAT5e KS DVOJITÁ 2 x RJ45 8/8



- KQ39PWXO
- KQ39TIXO
- KQ39ATXO
- KQ39BKXO

- KS keystone štandard upevnenia
- 2 x CAT5e, RJ45 8/8
- v súlade s normou 60603-7

SOCKET CAT5e KS DOUBLE 2x RJ45 8/8

- KS keystone fixing standard
- 2x CAT5e, RJ45 8/8
- in accordance with IEC 60603-7



ZÁSUVKA TEL LT RJ11 6/4



- KQ35PWXO
- KQ35TIXO
- KQ35ATXO
- KQ35BKXO

- skrutka TEL LT
- bezskrútkové upevnenie vodičov
- RJ11 6/4
- v súlade s normou 60603-7

SOCKET TEL LT RJ11 6/4

- TEL LT screw
- screw contacts
- RJ11 6/4
- in accordance with IEC 60603-7



ZÁSUVKA CAT6s KS RJ45 8/8 SLIM

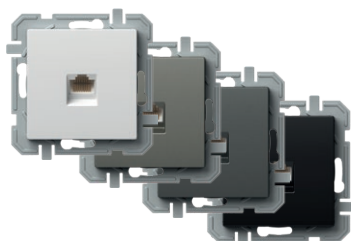

- KQ40PWXO
- KQ40TIXO
- KQ40ATXO
- KQ40BKXO

- KS keystone štandard upevnenia
- CAT6s, RJ45 8/8
- v súlade s normou 60603-7

SOCKET CAT6s KS RJ45 8/8 SLIM

- KS keystone fixing standard
- CAT6s, RJ45 8/8
- in accordance with IEC 60603-7



ZÁSUVKA CAT6s KS DVOJITÁ 2 x RJ45 8/8 SLIM

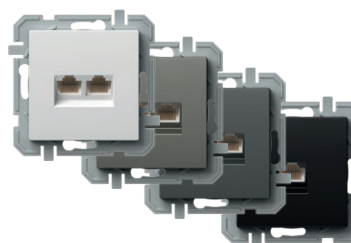

- KQ41PWXO
- KQ41TIXO
- KQ41ATXO
- KQ41BKXO

- KS keystone štandard upevnenia
- 2 x CAT6, RJ45 8/8
- v súlade s normou 60603-7

SOCKET CAT6s KS DOUBLE 2x RJ45 8/8 SLIM

- KS keystone fixing standard
- 2x CAT6s, RJ45 8/8
- in accordance with IEC 60603-7

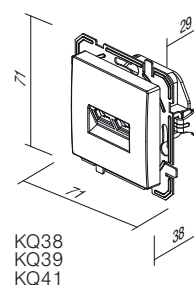
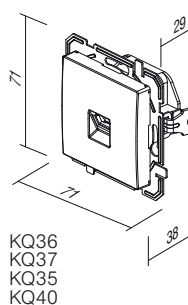
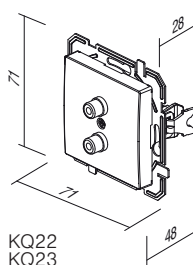
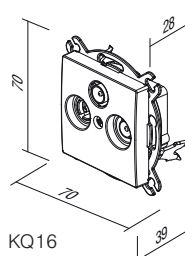
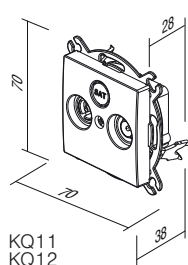
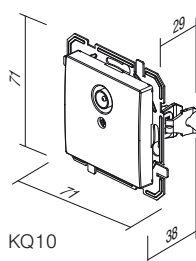



EQ15

PW

XO

typ type	názov description	technický popis technical data	farba colour	voliteľný popis 1 optional data 1
EQ15	STMIEVAČ ROTAČNÝ STRIEDAVÝ DIMMER ROTATIVE 2WAY	RL 400W	<input type="checkbox"/> PW biela lesklá polar white	XO bez rámu without cover plate
EQ16	STMIEVAČ ROTAČNÝ STRIEDAVÝ DIMMER ROTATIVE 2WAY	RLC 400W	<input type="checkbox"/> TI titánová titanium	
EQ19	STMIEVAČ ROTAČNÝ STRIEDAVÝ DIMMER ROTATIVE 2WAY	LED 100W	<input type="checkbox"/> AT antracitová anthracite	
·	·	·	<input type="checkbox"/> BK čierna black	

STMIEVAČ ROTAČNÝ STRIEDAVÝ RL 400 W

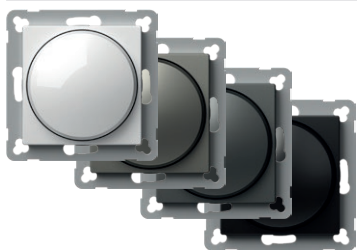

- EQ15PWXO
- EQ15TIXO
- EQ15ATXO
- EQ15BKXO



- rotačný so striedavým prepínačom
- zaťaženie RL, 40 W – 400 W
- možné prepojenie so striedavým prepínačom
- prepojenie s viacerými stmievačmi nie je povolené
- v súlade s normou EN 60669-1 a EN 60669-2-1
- bezskrútkové upevnenie vodičov 1,5 mm²
- napájanie 230 V~ 50 Hz
- obsahuje náhradnú poistku



DIMMER ROTATIVE 2WAY RL 400W

- rotation control with 2-way switch
- load RL, 40W - 400W
- 2-way switch combination is possible
- more dimmers combination is not allowed
- in accordance with EN 60669-1 and EN 60669-2-1
- plug-in contacts 1.5mm²
- supply 230V~ 50Hz
- replaceable fuse included

STMIEVAČ ROTAČNÝ STRIEDAVÝ RLC 400 W

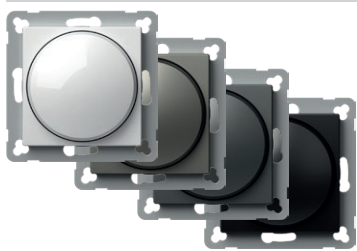

- EQ16PWXO
- EQ16TIXO
- EQ16ATXO
- EQ16BKXO



- rotačný so striedavým prepínačom
- zaťaženie RLC, 20 W – 400 W
- možné prepojenie so striedavým prepínačom
- prepojenie s viacerými stmievačmi nie je povolené
- v súlade s normou EN 60669-1 a EN 60669-2-1
- bezskrútkové upevnenie vodičov 1,5 mm²
- napájanie 230 V~ 50 Hz
- elektronický istič



DIMMER ROTATIVE 2WAY RLC 400W

- rotation control with 2-way switch
- load RLC, 20W - 400W
- 2-way switch combination is possible
- more dimmers combination is not allowed
- in accordance with EN 60669-1 and EN 60669-2-1
- plug-in contacts 1.5mm²
- supply 230V~ 50Hz
- electronic fuse

STMIEVAČ ROTAČNÝ STRIEDAVÝ LED 100 W

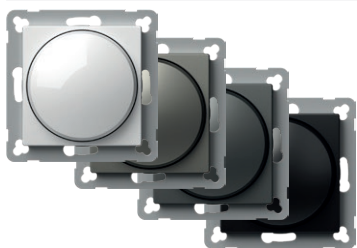

- EQ19PWXO
- EQ19TIXO
- EQ19ATXO
- EQ19BKXO



- rotačný so striedavým prepínačom
- zaťaženie: LED, 0 – 100 W (max. 10 LED diód)
GLS, 10 – 250 W
- možné prepojenie so striedavým prepínačom
- prepojenie s viacerými stmievačmi nie je povolené
- v súlade s normou EN 60669-1 a EN 60669-2-1
- bezskrútkové upevnenie vodičov 1,5 mm²
- napájanie 230 V~ 50 Hz
- obsahuje náhradnú poistku



DIMMER ROTATIVE 2WAY LED 100W

- rotation control with 2-way switch
- load: LED, 0-100W (max. 10 LEDs)
GLS, 10-250W
- 2-way switch combination is possible
- more dimmers combination is not allowed
- in accordance with EN 60669-1 and EN 60669-2-1
- plug-in contacts 1.5mm²
- supply 230V~ 50Hz
- replaceable fuse included

EQ15, EQ16, EQ19

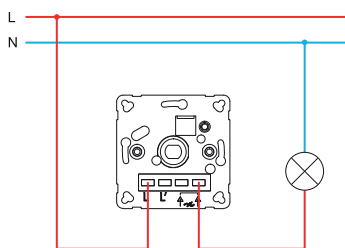

EQ15, EQ16, EQ19

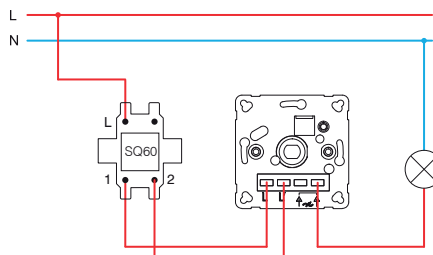

EQ15, EQ16, EQ19

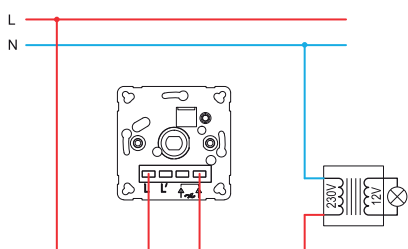

EQ15, EQ16, EQ19

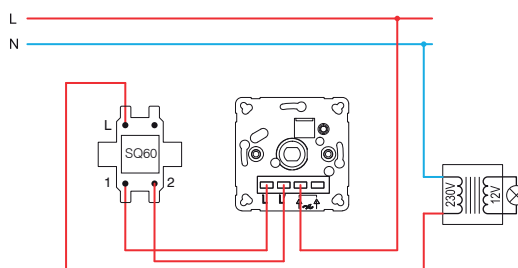

EQ16, EQ19

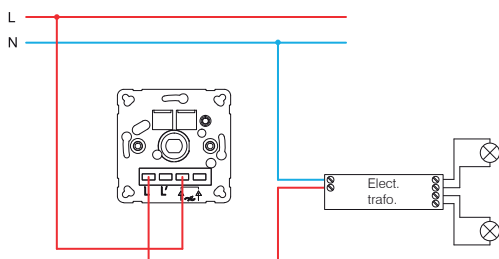

EQ16, EQ19

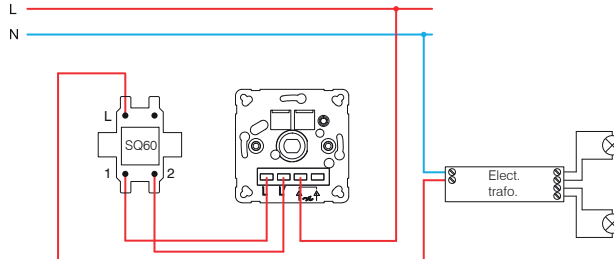
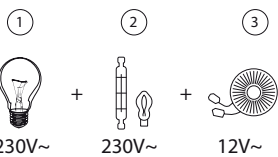
**EQ15 (40÷400W)**

- 1 – žiarovka/
incandescent lamp
2 – halogénová žiarovka/
halogen lamp

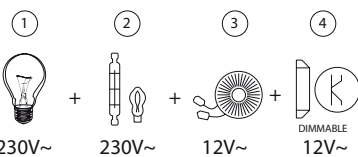
EQ16 (20÷400W)

- 3 – klasický transformátor/
classical transformer
4 – stmievateľný el. transformátor/
dimmable electronic transformer

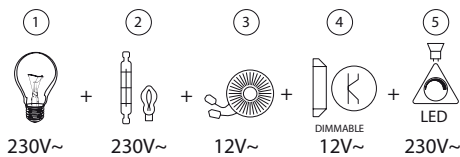
EQ19 (GLS 10÷250W ; LED 0÷100W)

- 5 – stmievateľná LED dióda/
dimmable LED lamp

OVĽADACÍ modul MZC pre EM18

EM17

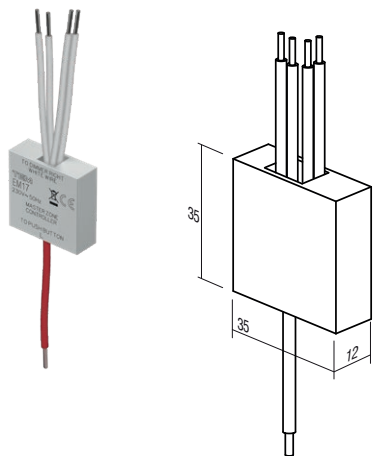

- Pripojte MZC podľa schémy zapojenia.
- Možné prepojenie s viacerými prepínačmi.
- Inštalácia iba jedného zariadenia do jednej krabice.
- Len pre použitie v interiéri.
- Napájanie: 230 V~ 50Hz
- Maximálny odpor vodičov: 50 kΩ
- Maximálny prúd na jednotku MZC: 10 mA
- Počet stmievačov na MZC: 1-4
- Maximálny počet MZC v zapojení: obmedzený na poistku v obvode
- Prevádzková teplota: -5 °C až 45 °C
- Teplota skladovania: -30 °C až 80 °C
- Maximálna vlhkosť: 90 % (bez kondenzácie)
- Rozmery krytu: 36 x 36 x 12 mm

MZC CONTROL Module for EM18

- Connect the MZC according to the wiring diagram.
- Possible wiring with several push buttons.
- Only one device installation per mounting box.
- For indoor use only.
- Power supply: 230V~ 50Hz
- Max. cable resistance: 50kΩ
- Max. current per MZC unit: 10mA
- Number of dimmers on MZC: 1-4
- Max. number of MZC in the wiring: limited to the fuse in the circuit
- Operating temperature: -5°C to 45°C
- Storage temperature: -30°C to 80°C
- Max. humidity: 90% (no condensation)
- Casing dimensions: 36x36x12 mm

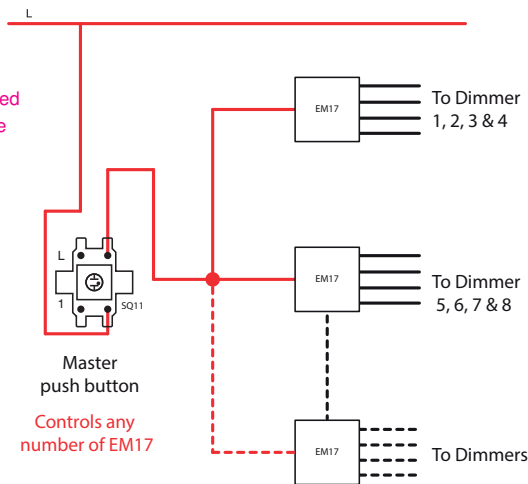
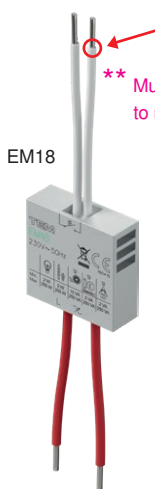
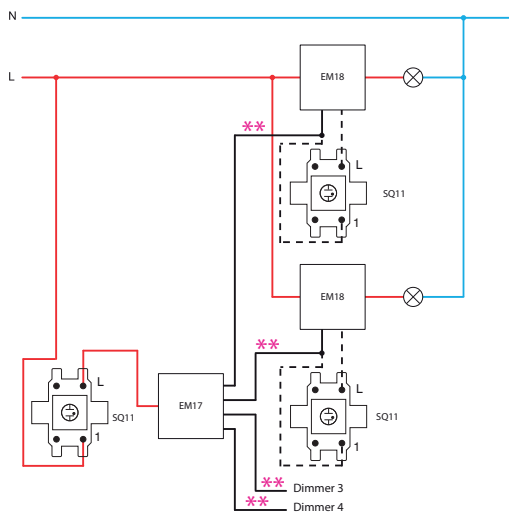

ZABUDOVATEĽNÝ STMIEVAČ LED 250W

EM18

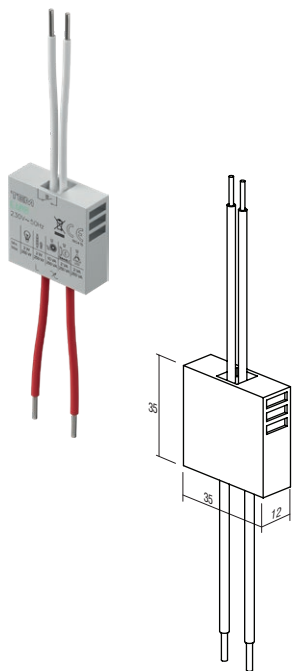

- zabudovateľný, ovládaný vonkajším tlačidlom
- nábehový alebo zostupový stmievač
- napájacie napätie 230 V ~ 50 Hz
- k dispozícii je niekoľko kombinácií tlačidiel
- funkcia zapamätania posledného nastavenia, okrem prípadu výpadku prúdu
- funkcia jemného zapnutia / vypnutia
- nastavenie minimálneho jasu
- inštalácia len jedného stmievača do jednej krabice
- len na použitie v interiéri
- v súlade s EN 60669-1 a EN 60669-2-1



DIMMER INBOX LED 250W

- inbox, controlled by external push button
- for leading or trailing edge
- supply voltage 230V~ 50Hz
- several push-buttons combinations is possible
- memory function of the last setting, except in the case of a power failure
- soft start / stop function
- minimum intensity control
- only one dimmer per wall box
- only for indoor usage
- in accordance with EN 60669-1 and EN 60669-2-1

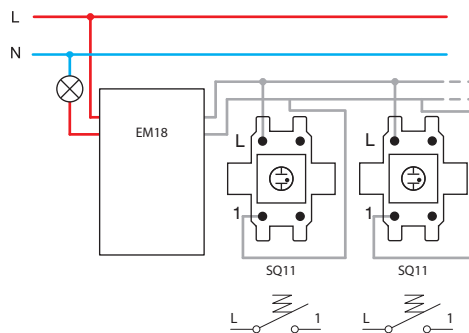

ZABUDOVAŤEL'NÝ STMIEVAČ DC LED 96W

EM19

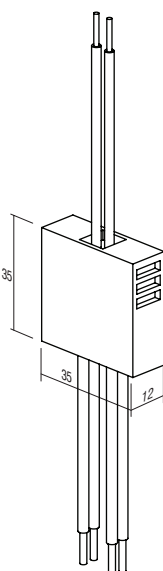

- zabudovateľný, ovládaný vonkajším tlačidlom
- zapojenie so všetkými LED predradníkmi s konštantným napätím a niektorými LED predradníkmi s konštantným prúdom, 9 - 48 V DC, max 96W (vhodné pre LED pásy)
- nie je určený na použitie s indukčnými záťažami
- možné zapojenie s viacerými tlačidlami a stmievačmi
- funkcia zapamätania posledného nastavenia, okrem prípadu výpadku prúdu
- funkcia jemného zapnutia / vypnutia
- inštalácia len jedného stmievača do jednej krabice
- len pre vnútorné použitie

DIMMER INBOX DC LED 96W

- inbox, controlled by external push button
- for use with constant voltage LED drivers and some constant current LED drivers, 9-48V DC, max 96W (also for LED strips)
- not for use with inductive loads
- several push-buttons combinations and several dimmers is possible
- memory function of the last setting, except in the case of a power failure
- soft start / stop function
- only one dimmer per wall box
- only for indoor usage

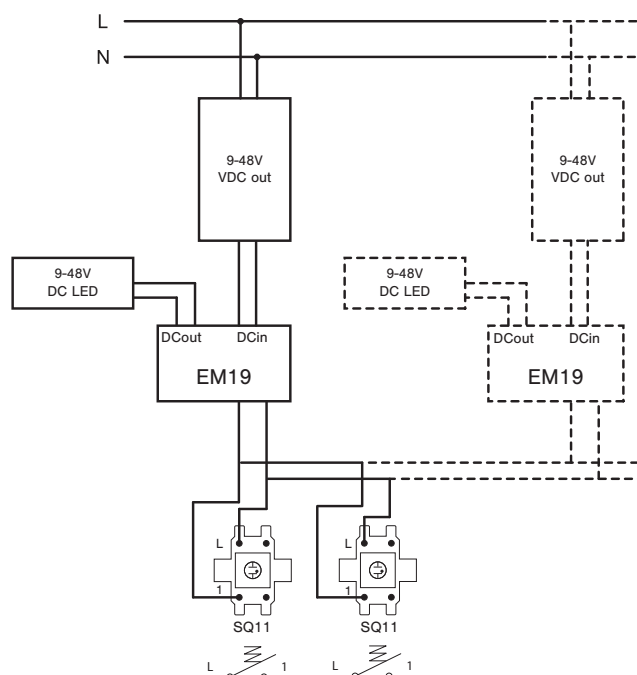
**POZORI!**

Ak sa do jednej krabice zapojí viac stmievačov, znížte maximálny spoločný výkon o 10 % pri každom stmievači.

ATTENTION!

If more dimmers are connected in one box reduce maximum common power for 10% for each dimmer.

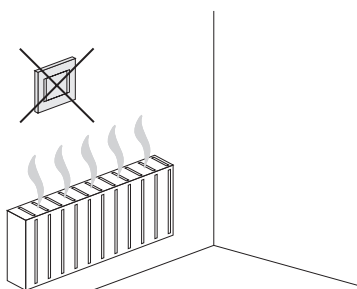

EM18 (2÷250VA)

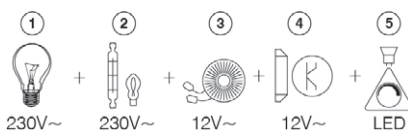

- 1 - žiarovka / incandescent lamp
- 2 - halogénová žiarovka / halogen lamp
- 3 - klasický transformátor / classical transformer
- 4 - stmievaťelný elektronický transformátor / dimmable electronic transformer
- 5 - stmievaťelná LED žiarovka / dimmable LED lamp

IR SPÍNAČ 5 A 230 V~



- EQ32PWXO
- EQ32TIXO
- EQ32ATXO
- EQ32BKXO



- infračervený spínač IR
- napájanie: 230 V~ ±10 % 50 Hz
- relé: 5 A/250 V~ prechod nulou
- stupeň bezpečnosti: IP40
- prierez vodiča na kontaktnej svorke: 0,75 – 2,5 mm²
- uhol detekcie: až 110° pri 20 °C
- detekčná oblasť: pribl. 8, pri 20 °C
- nastavitelné trvanie: od pribl. 5 s do 12 min
- nastavitelnosť jasu: od pribl. 5 do 200 LUX
- prevádzková teplota: od 0 °C do +40 °C
- nie je vhodný pre montáž do krabíc s hĺbkou 45 mm
- len pre použitie v interiéri

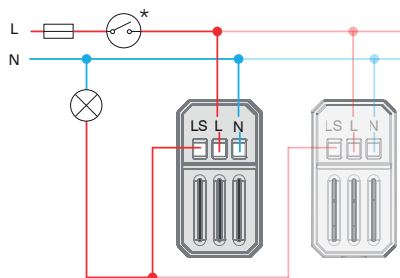

IR SWITCH 5A 230V~

- IR infrared switch
- supply voltage: 230V~ ±10 % 50Hz
- relay: 5A / 250V~ output for limited current with high resistance for zero crossing
- protection rating: IP40
- cross-section of wires at the contact terminal: 0.75 - 2.5 mm²
- detection angle: up to 110° at 20°C
- detection area: approx. 8 m at 20°C
- adjustability of duration: from approx. 5 s to 12 min
- adjustability of brightness: from approx. 5 to 200 LUX
- operating temperature: from 0°C to +40°C
- not suitable for installation in 45 mm deep boxes
- only for indoor usage

TERMOSTAT VYHRIEVANIE 10 A 230 V~

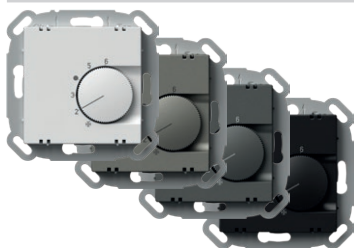

- EQ35PWXO
- EQ35TIXO
- EQ35ATXO
- EQ35BKXO

- prevádzkový režim: vyhrievanie
- napájanie: 230 V~, 50 Hz
- výkon: 4 A (max. 10 A), 230 V~, 50 Hz
- výstupný konektor: NO (max. 10 aktuátorov)
- oblasť regulácie: od +5 °C do +30 °C
- hysterezia: 0,5 K
- ochrana: IP30
- typ snímača: bimetal
- typ elektrického pripojenia: pružinové kontakty
- typ vodičov:
0,75 – 1,5 mm² (mäkké) alebo
1,0 – 2,5 mm² (tvrdé)

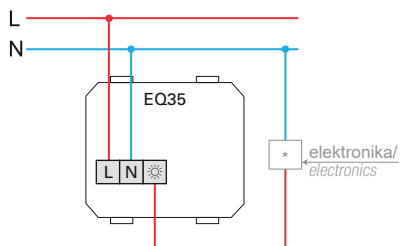

THERMOSTAT HEATING 10A 230V~

- operation mode: heating
- power supply: 230 V~, 50 Hz
- output: 4 A (max. 10 A), 230 V~, 50 Hz
- switching contact: NC (max. 10 actuators)
- regulation range: +5 °C to +30 °C
- hysteresis: 0,5 K
- protection: IP30
- sensor type: bimetal
- type of electrical connection: spring-loaded contacts
- type of conductors:
0,75 – 1,5mm² (flexible-stranded core) or
1,0 – 2,5 mm² (solid core)

TERMOSTAT VYHRIEVANIE/CHLADENIE 5 A 230 V~

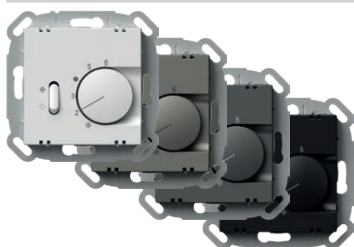

- EQ36PWXO
- EQ36TIXO
- EQ36ATXO
- EQ36BKXO

- prevádzkový režim: vyhrievanie/chladienie
- napájanie: 230 V~, 50 Hz
- výkon: 2 A (max. 5 A), 230 V~, 50 Hz
- výstupný konektor: prepínač (max. 5 aktuátorov)
- oblasť regulácie: od +5 °C do +30 °C
- hysterezia: 0,5 K
- ochrana: IP30
- typ snímača: bimetal
- typ elektrického pripojenia: pružinové kontakty
- typ vodičov:
0,75 – 1,5 mm² (mäkké) alebo
1,0 – 2,5 mm² (tvrdé)

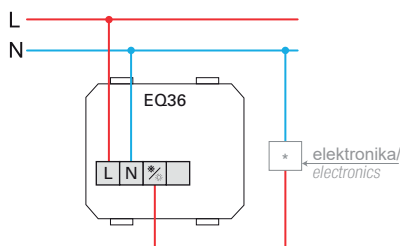

THERMOSTAT HEATING / COOLING 5A 230V~

- operation mode: heating / cooling
- power supply: 230 V~, 50 Hz
- output: 2 A (max. 5 A), 230 V~, 50 Hz
- switching contact: changeover switch (toggler, max. 5 actuators)
- regulation range: +5 °C to +30 °C
- hysteresis: 0,5 K
- protection: IP30
- sensor type: bimetal
- type of electrical connection: spring-loaded contacts
- type of conductors:
0,75 – 1,5mm² (flexible-stranded core) or
1,0 – 2,5 mm² (solid core)

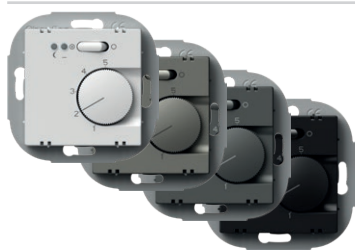

- EQ37PWXO
- EQ37TIXO
- EQ37ATXO
- EQ37BKXO

TERMOSTAT PODLAHOVÉ VYHRIEVANIE 16 A 230 V~

- prevádzkový režim: podlahové vyhrievanie
- napájanie: 230 V~, 50 Hz
- výkon: 2 A (max. 16 A), 230 V~, 50 Hz
- oblasť regulácie: od +10 °C do +50 °C
- hysterézia: 1 K
- ochrana: IP30
- typ snímača: NTC v súlade s DIN EN 60730-2-1
- indikátory:
 - červená LED pre vyhrievanie a
 - zelená LED pre nočný znížený režim
- typ elektrického pripojenia: pružinové kontakty
- typ vodičov: 0,5 – 2,5 mm²

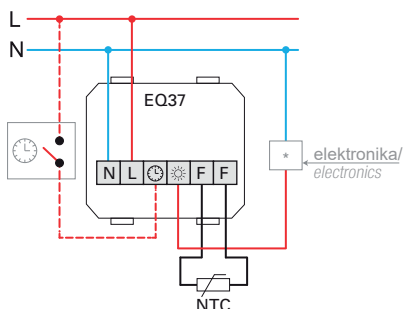

THERMOSTAT FLOOR HEATING 16A 230V~

- operation mode: floor heating
- power supply: 230 V~, 50 Hz
- output: 2 A (max. 16 A), 230 V~, 50 Hz
- regulation range: +10 °C to +50 °C
- hysteresis: 1 K
- protection: IP30
- sensor type: NTC in compliance with DIN EN 60730-2-1
- indicators: Red LED for heating and green LED for night decrease mode
- type of electrical connection: Screw contacts
- type of conductors: 0,5 – 2,5mm²



- EQ01PWXO

RÁDIO NA ZAPUSTENÚ MONTÁŽ + REPRODUKTOR DAB BLUETOOTH

- napájanie: 230 V~/50 Hz
- spotreba energie počas normálnej prevádzky: max. 6 W
- spotreba energie v pohotovostnom režime: < 0,5 W
- trieda ochrany: IP20
- frekvencia príjmu: DAB/DAB+ 174,928 – 239,200 MHz FM: 87,5 – 108 MHz
- bluetooth: Verzia V4.1, 2,402 – 2,480 GHz Trieda 2, maximálne +4 dBm
- hudobný výstup: 2 x 2 W RMS
- rozšírený vstup: Pre externý spínač (zapnutie rádia/pripravenosť)
- podmienky prostredia:
 - relatívna vlhkosť: Prevádzka: 10 – 75 % bez kondenzácie
 - skladovanie: 5 – 90 %
 - teplota: Prevádzka: 5 °C – 35 °C
 - skladovanie: -20 °C až 60 °C



BLUETOOTH



FLUSH MOUNTED RADIO + SPEAKER DAB BLUETOOTH

- power supply: 230 V~/ 50 Hz
- power consumption during normal operation: max. 6 W
- power consumption when on standby: < 0.5 W
- protection class: IP20
- reception frequencies: DAB/DAB+ 174.928 - 239.200 MHz FM: 87.5 - 108 MHz
- bluetooth: Version V4.1, 2.402-2.480 GHz Class 2, max. +4 dBm
- music output: 2 x 2W RMS
- extension input: For external switch (Switches radio on/ standby)
- ambient conditions
 - relative humidity: Operation: 10 % - 75 % non-condensing
 - storage: 5 % - 90 %
 - temperature: Operation: 5 °C - 35 °C
 - storage: -20 °C - 60 °C

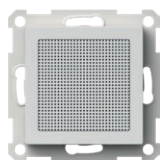

- EQ02PWXO

REPRODUKTOR NA ZAPUSTENÚ MONTÁŽ

- trieda ochrany: IP20
- hudobná sila: 2 W RMS
- podmienky prostredia:
 - relatívna vlhkosť: Prevádzka: 10 – 75 % bez kondenzácie
 - skladovanie: 5 – 90 %
 - teplota: Prevádzka: 5 – 35 °C
 - skladovanie: -20 °C až 60 °C



FLUSH MOUNTED SPEAKER

- protection class: IP20
- music power: 2W RMS
- ambient conditions
 - relative humidity: Operation: 10 % - 75 % non-condensing
 - storage: 5 % - 90 %
 - temperature: Operation: 5 °C - 35 °C
 - storage: -20 °C - 60 °C

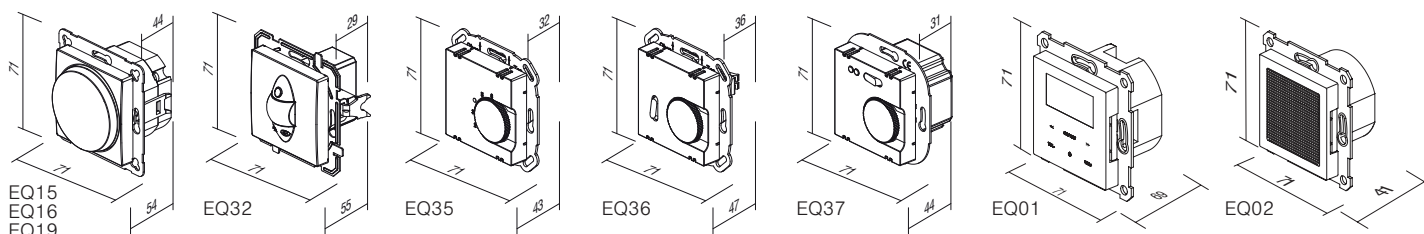

EQ15
EQ16
EQ19

EQ32

EQ35

EQ36

EQ37

EQ01

EQ02

NABÍJAČKA USB PD 20 W



- EQ69PWXO
- EQ69TIXO
- EQ69ATXO
- EQ69BKXO

- USB napájací zdroj s napájaním do 20 W.
- na nabíjanie elektronických zariadení cez štandardný USB port (kompatibilné aj so zariadeniami Apple)
- napájanie: 100 – 230 V~ 50/60 Hz
- spotreba počas prevádzky:
- 420 mA pri 100 V~/220 mA pri 230 V~
- spotreba v pohotovostnom režime: < 100 mW pri 230 V~
- výstupné napätie: 20 W Max

Výstup:

- USB typ C: 5,0 VDC 3,0 A; 9,0 VDC 2,2 A; 12,0 VDC 1,67 A (PD 20 W)
- USB typ A: 5,0 VDC 3,0 A; 9,0 VDC 2,0 A; 12,0 VDC 1,5 A (QC 18 W)
- USB A + C: 5 VDC 3 A
- typ konektora: 1x USB A; 1x USB C
- priemerná účinnosť v aktívnom stave: 86 %
- účinnosť pri minimálnom zaťažení (10 %): 81 %
- prevádzková teplota: 0 °C/+ 45 °C (použitie v interiéri)
- trieda ochrany IP: - IP20, na použitie len v interiéri
- zariadenie bezpečnostnej triedy II
- prepäťová ochrana (EN 60364-4-44): trieda III
- skrutkové upevnenie vodičov max. 2,5 mm²
- zariadenie s posunom kontaktov min. 3 mm
- nie je vhodný na montáž do krabíc s hĺbkou 45 mm a krabice CUBO IP20

Vyhovuje:

Smerniciam: BT, EMC, RoHS, ErP
 Štandardom: EN IEC 62368-1, EN 55032, EN55035, EN IEC 61000-3-2, EN 61000-3-3, EN 50563, EN IEC 63000
 Ďalším predpisom: (EU) n. 2019/1782 REACh, n. 1907/2006 – art.33.
 Výrobok môže obsahovať stopy olova.



USB POWER SUPPLY UNIT PD 20W

- 20 W USB power delivery power supply unit
- for charging of electronic devices via a standard USB port (also compatible with Apple devices)
- power supply: 100-230V~ 50/60Hz
- power consumption: 420mA at 100V~/220mA at 230V~
- standby power consumption: <100mW at 230V~
- Output power: 20 W Max

- Output:

- USB tip C: 5.0 VDC 3.0A; 9.0 VDC 2.2 A; 12.0 VDC 1.67 A (PD 20W)
- USB tip A: 5.0 VDC 3.0A; 9.0 VDC 2.0 A; 12.0 VDC 1.5 A (QC 18W)
- USB A+C: 5 VDC 3A
- connector type: 1x USB A; 1x USB C
- average efficiency in active mode: 86%
- efficiency with low load (10%): 81%
- operating temperature: 0°C/+45°C (indoor use)
- IP protection class: IP20, indoor use only
- class device II
- overvoltage category (EN 60364-4-44): Class III
- screw contacts: max. 2.5 mm²
- device with a contact gap of at least 3mm

Conformity:

Directive: BT, EMC, RoHS, ErP
 Standards: EN IEC 62368-1, EN 55032, EN55035, EN IEC 61000-3-2, EN 61000-3-3, EN 50563, EN IEC 63000
 External power supplies regulation: (EU) n. 2019/1782 REACh, n. 1907/2006 – art.33. The product may contain traces of lead.

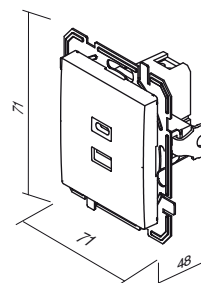

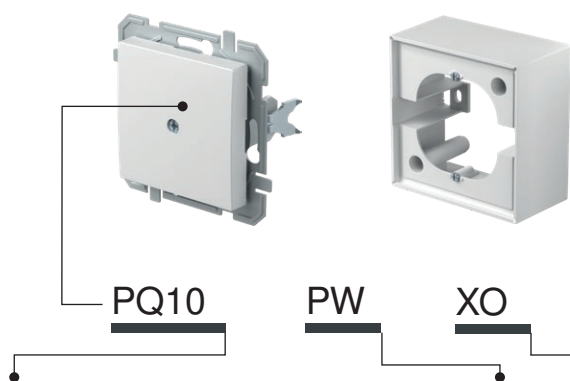

typ type	názov description	farba colour	voľiteľný popis 1 optional data 1
PQ10	VÝPLŇ BLANK	<input type="checkbox"/> PW biela lesklá polar white	XO bez rámu without cover plate
PQ30	KRYT TAE/TDO COVER TAE/TDO	<input type="checkbox"/> TI titánová titanium <input type="checkbox"/> AT antracitová anthracite <input type="checkbox"/> BK čierna black	

VÝPLŇ



- PQ10PWXO - na zakrytie prázdnych otvorov
- PQ10TIXO *BLANK*
- PQ10ATXO - for filling up empty spaces
- PQ10BKXO



KRYT TAE/TDO

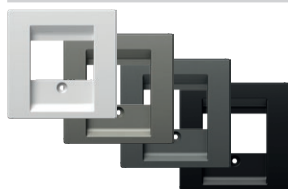

- PQ30PW - kryt TAE alebo TDO so skrutkou
- PQ30TI *COVER TAE/TDO*
- PQ30AT - TAE or TDO cover with screw
- PQ30BK

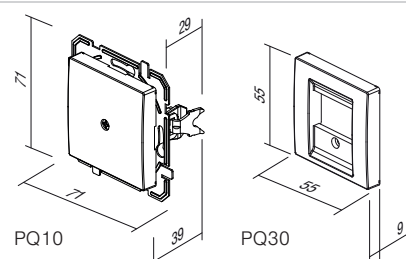

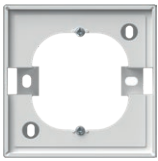

□ PQ20PWF

KRABICA PRE POVRCHOVÚ MONTÁŽ 1

- krabica na povrchovú montáž FLAT
SURFACE MOUNT BOX 1
 - surface mounting box FLAT

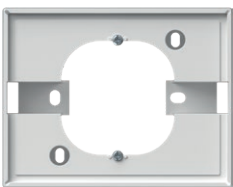

□ PQ21PWF

POVRCHOVÁ KRABICA PRE DVOJITÚ ZÁSUVKU

- krabica na povrchovú montáž FLAT
SURFACE MOUNT BOX FOR DOUBLE SOCKET
 - surface mounting box FLAT





- PQ22PWF
- PQ22TIF
- PQ22ATF
- PQ22BKF

SÚPRAVA SPÍNAČOV FLAT IP44

- na použitie vo vlhkých oblastiach
- ochrana IP44 pre spínače LOGIQ (SQ10, SQ11, SQ22, SQ60, SQ70)
- spínače a tlačidlá nie sú súčasťou súpravy
- FLAT rámik
- v súlade s normou IEC 60669-1



SET SWITCHES FLAT IP44

- for usage in humid areas
- IP44 protection provides for LOGIQ switches (SQ10, SQ11, SQ22, SQ60, SQ70)
- switches and buttons are not part of the set
- FLAT cover plate
- in accordance with IEC 60669-1



- PQ23PWF
- PQ23TIF
- PQ23ATF
- PQ23BKF

SÚPRAVA ZÁSUVIEK FLAT IP44

- na použitie vo vlhkých oblastiach
- ochrana IP44 je možné dosiahnuť len v kombinácii s krytou zásuvkou (VQ11XO, VQ13XO, VQ41XO, VQ43XO)
- zásuvky nie sú súčasťou súpravy
- FLAT rámik
- v súlade s normou IEC 60884-1



SOCKETS FLAT IP44



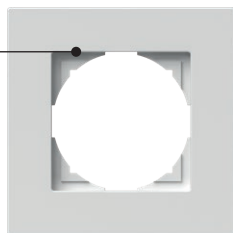

- for usage in humid areas
- IP44 protection can be achieved only in combination with covered socket (VQ11XO, VQ13XO, VQ41XO, VQ43XO)
- sockets are not part of the set
- FLAT cover plate
- in accordance with IEC 60884-1

R Á M I K Y F L A T O F







OF10

PW

typ type	názov description	farba colour
OF10	RÁMIK FLAT 1 COVER PLATE FLAT 1	 PW biela lesklá polar white
OF20	RÁMIK FLAT 2 COVER PLATE FLAT 2	 TI titánová titanium
OF30	RÁMIK FLAT 3 COVER PLATE FLAT 3	 AT antracitová anthracite
.	.	 BK čierna black
.	.	

RÁMIK FLAT 1



	OF10PW
	OF10TI
	OF10AT
	OF10BK



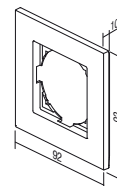

- dekoratívny samostatný rámik
- v súlade s normou EN 60669-1

COVER PLATE FLAT 1
- decorative cover plate 1-gang
- in accordance with EN 60669-1



RÁMIK FLAT 2



	OF20PW
	OF20TI
	OF20AT
	OF20BK

- dekoratívny dvojité rámik
- v súlade s normou EN 60669-1



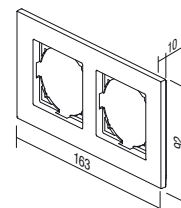

COVER PLATE FLAT 2
- decorative cover plate 2-gang
- in accordance with EN 60669-1



COVER PLATES FLAT OF

RÁMIK FLAT 3



	OF30PW
	OF30TI
	OF30AT
	OF30BK



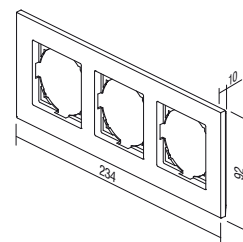

- dekoratívny trojitý rámiK
- v súlade s normou EN 60669-1

COVER PLATE FLAT 3
- decorative cover plate 3-gang
- in accordance with EN 60669-1



RÁMIK FLAT 4



	OF40PW
	OF40TI
	OF40AT
	OF40BK



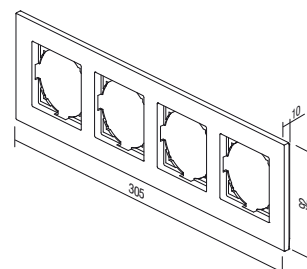

- dekoratívny štvoritý rámiK
- v súlade s normou EN 60669-1

COVER PLATE FLAT 4
- decorative cover plate 4-gang
- in accordance with EN 60669-1



RÁMIK FLAT 5



	OF50PW
	OF50TI
	OF50AT
	OF50BK

- dekoratívny 5-miestny rámiK
- v súlade s normou EN 60669-1

COVER PLATE FLAT 5
- decorative cover plate 5-gang
- in accordance with EN 60669-1

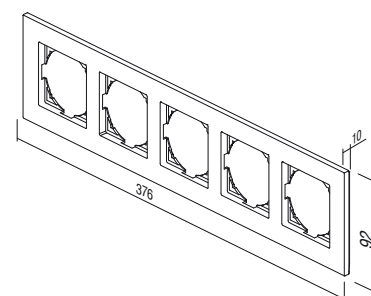



R Á M I K Y B O L D O Q







OQ10

PW

typ type	názov description	farba colour
OQ10	RÁMIK BOLD 1 COVER PLATE BOLD 1	 PW biela lesklá polar white
OQ20	RÁMIK BOLD 2 COVER PLATE BOLD 2	 TI titánová titanium
OQ30	RÁMIK BOLD 3 COVER PLATE BOLD 3	 AT antracitová anthracite
:	:	 BK čierna black
:	:	

RÁMIK BOLD 1



	OQ10PW
	OQ10TI
	OQ10AT
	OQ10BK

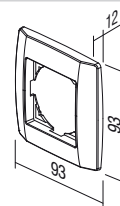

- dekoratívny samostatný rámik
- v súlade s normou EN 60669-1

COVER PLATE BOLD 1
- decorative cover plate 1-gang
- in accordance with EN 60669-1



RÁMIK BOLD 2



	OQ20PW
	OQ20TI
	OQ20AT
	OQ20BK

- dekoratívny dvojité rámik
- v súlade s normou EN 60669-1

COVER PLATE BOLD 2
- decorative cover plate 2-gang
- in accordance with EN 60669-1

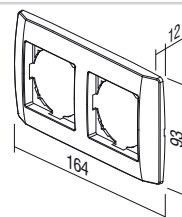

C O V E R P L A T E S B O L D O Q

RÁMIK BOLD 3



	QQ30PW
	QQ30TI
	QQ30AT
	QQ30BK

- dekoratívny trojitý rámik
- v súlade s normou EN 60669-1

COVER PLATE BOLD 3
- decorative cover plate 3-gang
- in accordance with EN 60669-1

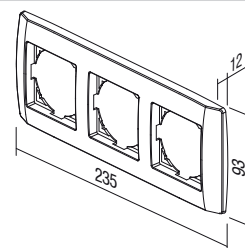

RÁMIK BOLD 4



	QQ40PW
	QQ40TI
	QQ40AT
	QQ40BK

- dekoratívny štvoritý rámik
- v súlade s normou EN 60669-1

COVER PLATE BOLD 4
- decorative cover plate 4-gang
- in accordance with EN 60669-1

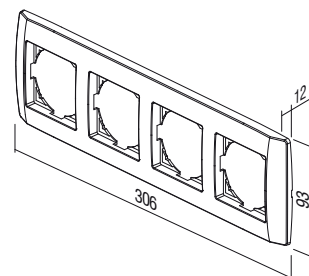

RÁMIK BOLD 5



	QQ50PW
	QQ50TI
	QQ50AT
	QQ50BK

- dekoratívny 5-miestny rámik
- v súlade s normou EN 60669-1

COVER PLATE BOLD 5
- decorative cover plate 5-gang
- in accordance with EN 60669-1

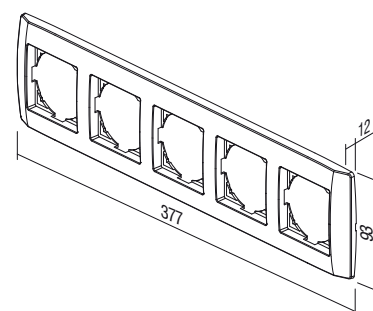

R Á M I K Y P R I M E O R

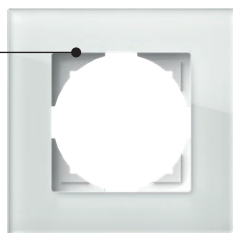

OR10

PW

typ type	názov description	farba colour
OR10	RÁMIK PRIME 1 COVER PLATE PRIME 1	GL biela glass light
OR20	RÁMIK PRIME 2 COVER PLATE PRIME 2	GD čierna glass dark
OR30	RÁMIK PRIME 3 COVER PLATE PRIME 3	
⋮	⋮	
⋮	⋮	

RÁMIK PRIME 1

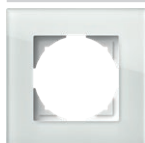

OR10GL
OR10GD

- dekoratívny samostatný rámik
- v súlade s normou EN 60669-1

COVER PLATE PRIME 1
- decorative cover plate 1-gang
- in accordance with EN 60669-1

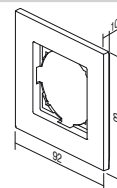

RÁMIK PRIME 2



OR20GL
OR20GD

- dekoratívny dvojité rámik
- v súlade s normou EN 60669-1

COVER PLATE PRIME 2
- decorative cover plate 2-gang
- in accordance with EN 60669-1

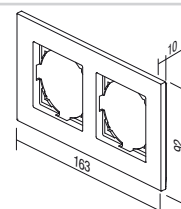

C O V E R P L A T E S P R I M E O R



OR30GL
 OR30GD

RÁMIK PRIME 3

- dekoratívny trojitý rámik
 - v súlade s normou EN 60669-1

COVER PLATE PRIME 3

- decorative cover plate 3-gang
 - in accordance with EN 60669-1

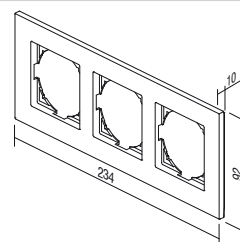

OR40GL
 OR40GD

RÁMIK PRIME 4

- dekoratívny štvoritý rámik
 - v súlade s normou EN 60669-1

COVER PLATE PRIME 4

- decorative cover plate 4-gang
 - in accordance with EN 60669-1

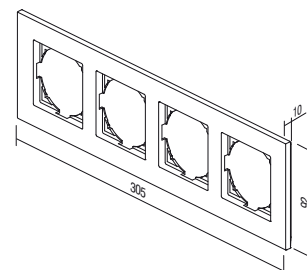

TEM

ekonomik





ekonomik

NAVRHNUTÉ PRE DOKONALOSŤ **Podstatný je štýl**

Neutrálny, kompaktný a elegantný dizajn sa prispôsobí každému obytnému alebo pracovnému priestoru. V interiéroch sa nevyníma, ale harmonicky s ním ladí.

PLANNED FOR EXCELLENCE **Style is essential**

A neutral, compact, elegant design is adjustable to every working or living area. It does not stick out from the interior, but rather harmonically fits into it.





ekonomik

HARMÓNIA FARIEB Vyber si svoj odtieň

Túžby vedia byť rozličné. Práve preto sme venovali veľkú pozornosť výberu možností, ktoré vám poskytnú správnu odpoveď. Neutrálna paleta farieb iba doplní atmosféru miestnosti – nebude vás obmedzovať.

HARMONY OF COLOURS Choose your hue

Desires can be very different. Therefore we have carefully selected possibilities for you, which can offer you the right answer. A neutral palette of colours will only complement your ambient - it will not restrict it.

<input type="checkbox"/> PW	biela lesklá	<i>polar white</i>
<input type="checkbox"/> IW	béžová lesklá	<i>ivory white</i>
<input type="checkbox"/> ES	strieborná matná	<i>elox silver</i>
<input type="checkbox"/> CO	biela duroplast	<i>white thermoset</i>
<input type="checkbox"/> NB	čierna lesklá	<i>night black</i>





JEDNODUCHO PRE NAJNÁROČNEJŠÍCH

Starostlivým plánovaním sme zabezpečili ochranu prvkov pod napätím pred dotykom. Základné upevnenie mechanizmov pomocou svoriek (1) môžete ešte dodatočne upevniť skrutkami (2). Tento spôsob je obzvlášť vhodný pre bezpečné a spoľahlivé upevnenie zásuvky.

SIMPLE FOR THE MOST DEMANDING

By careful planning elements under voltage have been protected against touching. Basic fixing of mechanisms with fixing claws (1) allows additional strengthening with screws (2). This manner is especially appropriate for safe and reliable fixing of sockets.

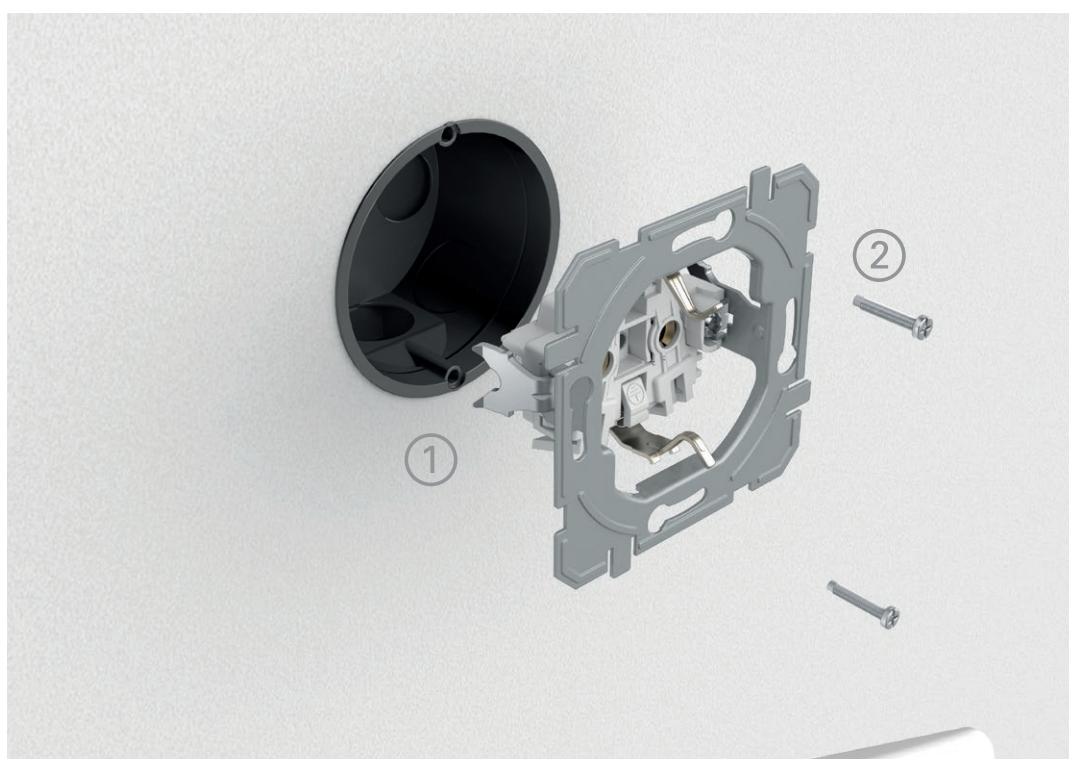

KOMBINUJTE PODĽA SVOJHO ŽELANIA.
COMBINE AS YOU PLEASE.

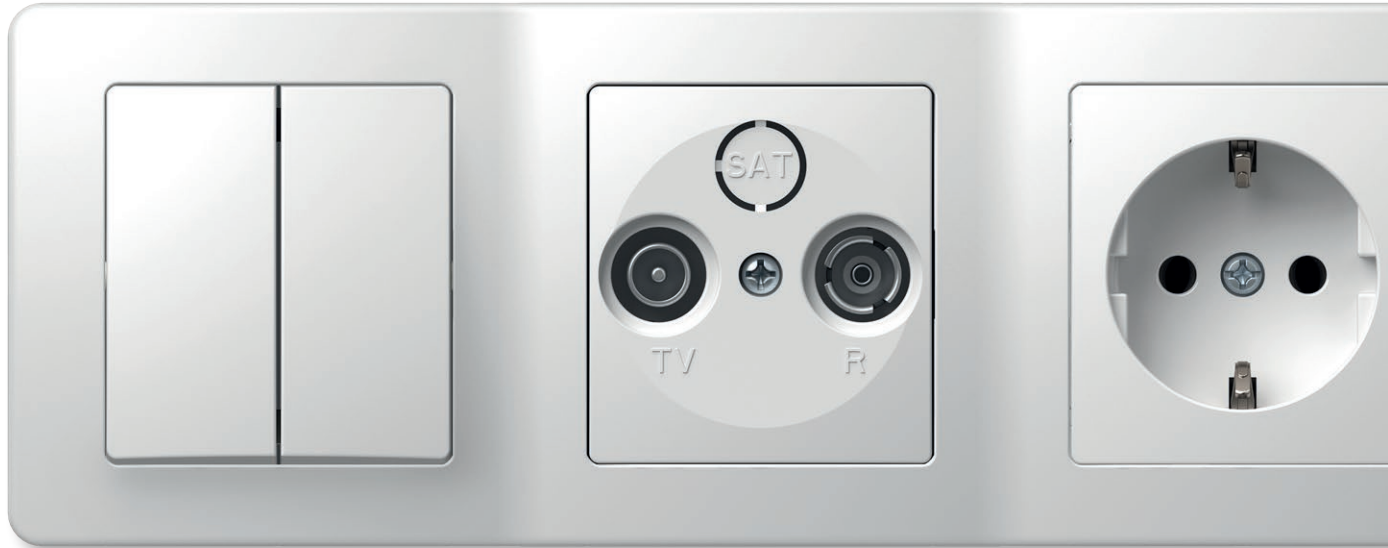

Kombinácie znamenajú úsporu miesta na stene. Keď máte málo miesta, správnym rozhodnutím je zvislá kombinácia.

With combining you save space on the wall. When faced with a limited space, »vertically« is the right decision.

JEDNODUCHÁ MONTÁŽ

Ekonomik je riešením pre systém štandardných okrúhlych krabíc. S ním môžete plánovať jednoduché aj zložitejšie inštalácie, novostavby a úpravy. Systém obsahuje bezskrútkové kontakty, ktoré vám šetria čas pri inštalácii prvkov.

EASY INSTALLATION

Ekonomik is a solution for the system of standardized round installations boxes. It can be used for simple as well as more demanding installations, new buildings and adaptations. The system is characterised by plug-in contacts which save time during installation of elements.

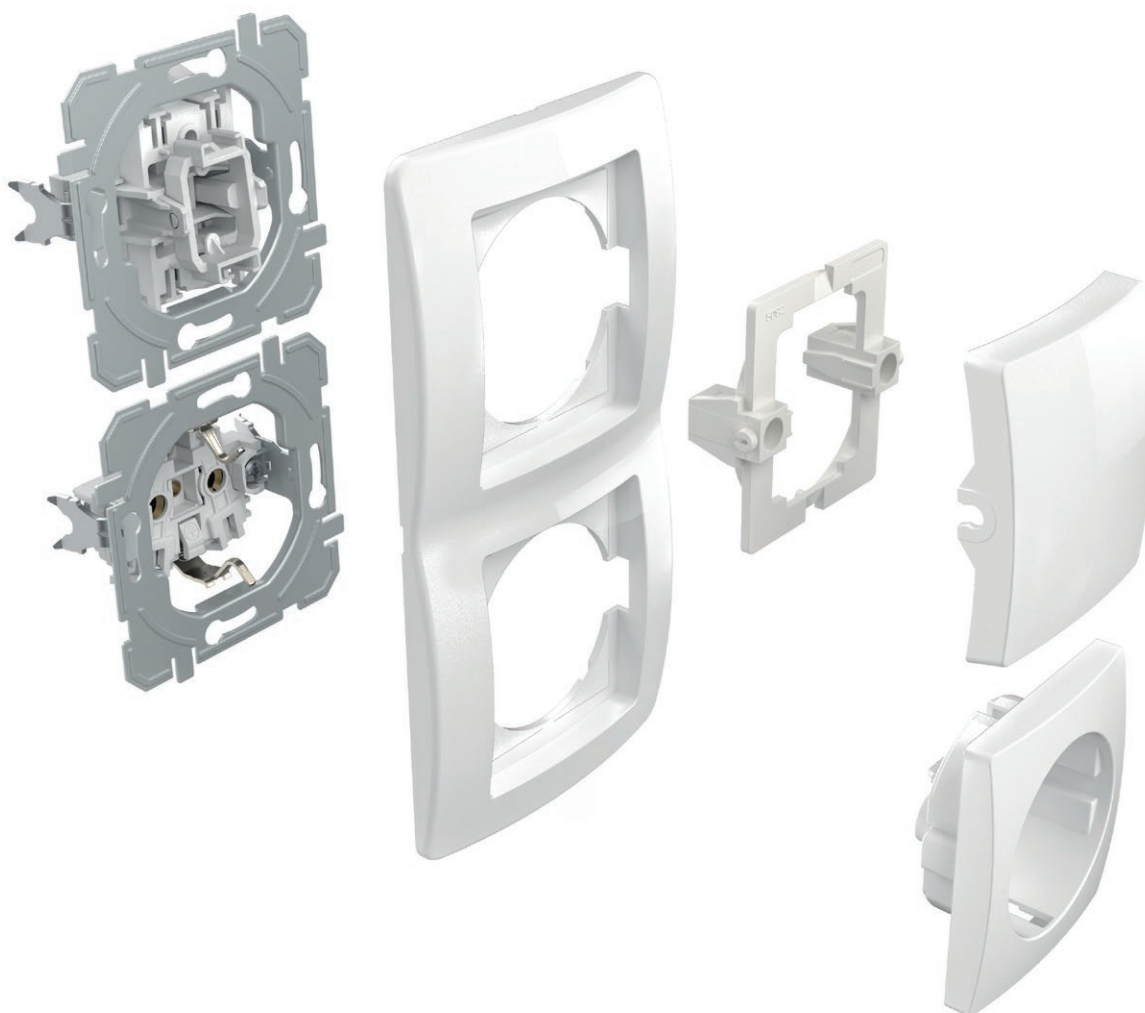

DOBŘÉ VEDIEŤ

GOOD TO KNOW



Všetky zásuvky sú vybavené bezpečnostnou poistkou zabezpečujúcou ochranu pred dotykcom kontaktov pod napätím.

All the sockets are equipped with a safety shutters assuring the protection to live contacts.



Premyslená konštrukcia spínača umožňuje ľahkú indikáciu aj dodatočne.

The well-thought-out design of the switch enables the easy integration of the indication, including at a later time.



Kontakty zo striebornej zliatiny zaisťujú spoľahlivosť spínania.

Contacts made of silver alloy guarantee safe switching.



Bezskrutkové kontakty umožňujú rýchle a spoľahlivé pripojenie vodičov. Na ten istý kontakt môžete upevniť dva vodiče rôznych priemerov.

Plug-in contacts enable quick and reliable attachment of wires. Two wires of different diameters can be attached to the same contact.



Rozperky umožňujú hlbšie upevnenie (aj cez keramické obkladačky a pod.).







Fixing claws enable deeper fixing (also through ceramic tiles, etc.)

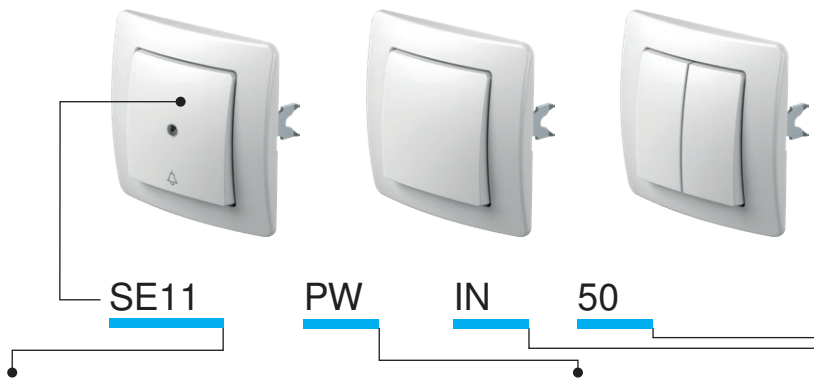

Inštalčné krabice s jednoduchou inštaláciou vám uľahčia prácu. Správne vzdialenosti sú zaručené.

Easy-fitting installation boxes will make your work easier. Proper lengths are guaranteed.



typ type	popis description	technické dáta technical data	farba colour	voliteľné údaje 1 optional data 1	voliteľné údaje 2 optional data 2
SE10	SPÍNAČ JEDNOPÓLOVÝ SWITCH 1WAY	10AX 250V~	<input type="checkbox"/> PW polárna biela polar white	 NT neutrálna neutral	 50
SE11	TLAČIDLO JEDNOPÓLOVÉ PUSH BUTTON 1WAY	10A 250V~	<input type="checkbox"/> IW slonová kosť ivory white		 51
SE22	SPÍNAČ DVOJPÓLOVÝ SWITCH 2POLE	16AX 250V~	<input type="checkbox"/> ES strieborná matná elox silver		 03
...	<input type="checkbox"/> CO biely duroplast white thermoset		 04
...	<input type="checkbox"/> NB čierna lesklá night black		...

SPÍNAČ JEDNOPÓLOVÝ 10 AX 250 V ~

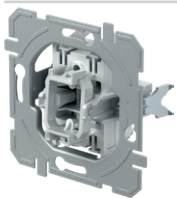

SE10

- 10 AX 250 V ~, typ SE10
- v súlade s normou EN 60669-1
- bezskrútkové upevnenie vodičov 1,5 – 2,5 mm²

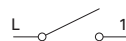

- SWITCH 1WAY 10AX 250V~
- 10AX 250V~, type SE10
 - in accordance with EN 60669-1
 - plug-in contacts 1.5-2.5mm²

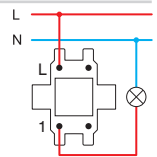

TLAČIDLO JEDNOPÓLOVÉ 10 A 250 V ~

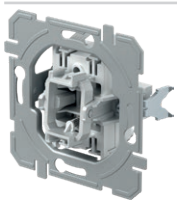

SE11

- 10 A 250 V ~, typ SE11
- v súlade s normou EN 60669-1
- bezskrútkové upevnenie vodičov 1,5 – 2,5 mm²

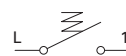

- PUSH BUTTON 1WAY 10A 250V~
- 10A 250V~, type SE11
 - in accordance with EN 60669-1
 - plug-in contacts 1.5-2.5mm²

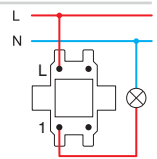

SPÍNAČ DVOJPÓLOVÝ 16AX 250V~

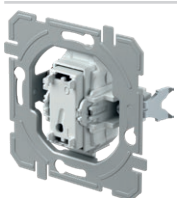

SE22

- 16 AX 250 V ~, typ SE22
- v súlade s normou EN 60669-1
- skrútkové upevnenie vodičov 1,5 – 2,5 mm²
- len v kombinácii s tlačidlom TE10_NT03

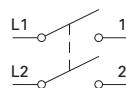

- SWITCH 2POLE 16AX 250V~
- 16AX 250V~, type SE22
 - in accordance with EN 60669-1
 - screw contacts 1.5-2.5mm²
 - only in combination with button TE10_NT03

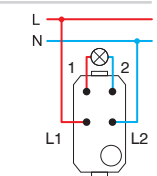

SPÍNAČ SÉRIOVÝ 10 AX 250 V ~

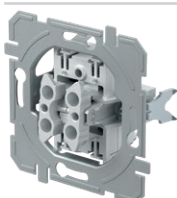

SE50

- 10 AX 250 V ~, typ SE50
- v súlade s normou EN 60669-1
- bezskrútkové upevnenie vodičov 1,5 – 2,5 mm²

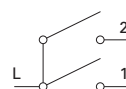

- SWITCH 2GANG-1WAY 10AX 250V~
- 10AX 250V~, type SE50
 - in accordance with EN 60669-1
 - plug-in contacts 1.5-2.5mm²

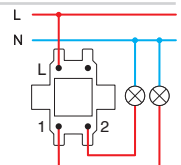

S W I T C H E S S E

TLAČIDLO SÉRIOVÉ 10 A 250 V ~

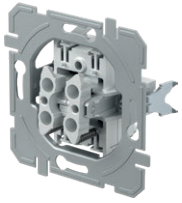

SE51

- 10 A 250 V ~, typ SE51
- v súlade s normou EN 60669-1
- bezskrútkové upevnenie vodičov 1,5 – 2,5 mm²

PUSH BUTTON 2GANG-1WAY 10A 250V~

- 10A 250V~, type SE51
- in accordance with EN 60669-1
- plug-in contacts 1.5-2.5mm²

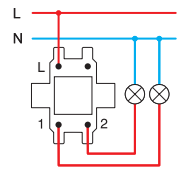
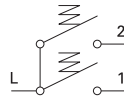

ŽALÚZIOVÝ SPÍNAČ 10AX 250V~

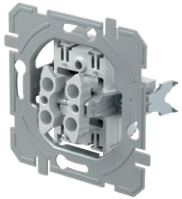

SE52

- 10 AX 250 V ~, typ SE52
- v súlade s normou EN 60669-1
- bezskrútkové upevnenie vodičov 1,5 – 2,5 mm²
- s mechanickou blokadou súčasného zapnutia

SWITCH SHUTTERS 10AX 250V~

- 10AX 250V~, type SE52
- in accordance with EN 60669-1
- plug-in contacts 1.5-2.5mm²
- with mechanical interblock

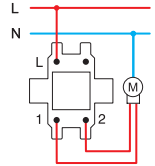
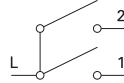

ŽALÚZIOVÉ TLAČIDLO 10 A 250 V ~

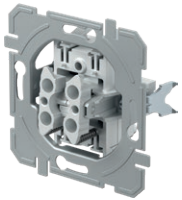

SE53

- 10 A 250 V ~, typ SE53
- v súlade s normou EN 60669-1
- bezskrútkové upevnenie vodičov 1,5 – 2,5 mm²
- s mechanickou blokadou súčasného zapnutia

PUSH BUTTON SHUTTERS 10A 250V~

- 10A 250V~, type SE53
- in accordance with EN 60669-1
- plug-in contacts 1.5-2.5mm²
- with mechanical interblock

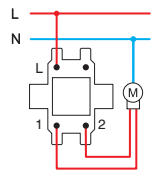
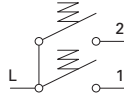

STRIEDAVÝ PREPÍNAČ 10 AX 250 V ~

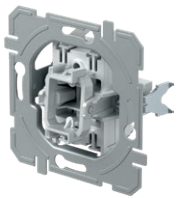

SE60

- 10 AX 250 V ~, typ SE60
- v súlade s normou EN 60669-1
- bezskrútkové upevnenie vodičov 1,5 – 2,5 mm²

SWITCH 2WAY 10AX 250V~

- 10AX 250V~, type SE60
- in accordance with EN 60669-1
- plug-in contacts 1.5-2.5mm²

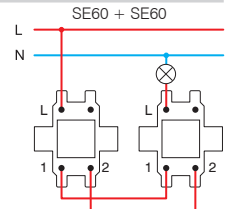
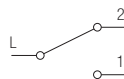

STRIEDAVÝ PREPÍNAČ DVOJITÝ 10 AX 250 V ~

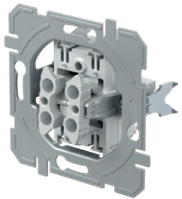

SE63

- 10 AX 250 V ~, typ SE63
- v súlade s normou EN 60669-1
- bezskrútkové upevnenie vodičov 1,5 – 2,5 mm²

SWITCH DOUBLE 2WAY 10AX 250V~

- 10AX 250V~, type SE63
- in accordance with EN 60669-1
- plug-in contacts 1.5-2.5mm²

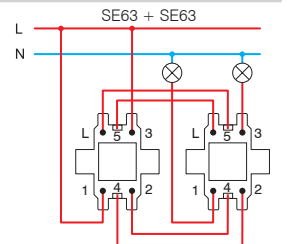

KRÍŽOVÝ PREPÍNAČ 10 AX 250 V ~

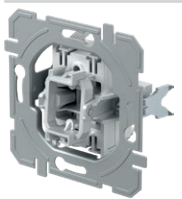

SE70

- 10 AX 250 V ~, typ SE70
- v súlade s normou EN 60669-1
- bezskrútkové upevnenie vodičov 1,5 – 2,5 mm²

SWITCH INTERMEDIATE 10AX 250V~

- 10AX 250V~, type SE70
- in accordance with EN 60669-1
- plug-in contacts 1.5-2.5mm²

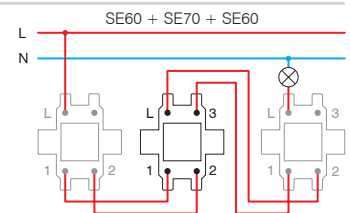

SPÍNAČ JEDNOPÓLOVÝ 10 AX 250 V ~



- SE10PW
- SE10IW
- SE10ES
- SE10CO
- SE10NB

- 10 AX 250 V ~, typ SE10
 - v súlade s normou EN 60669-1
 - bezskrútkové upevnenie vodičov 1,5–2,5 mm²

SWITCH 1WAY 10AX 250V~
 - 10AX 250V~, type SE10
 - in accordance with EN 60669-1
 - plug-in contacts 1.5-2.5mm²



SPÍNAČ JEDNOPÓLOVÝ 10 AX 250 V ~ __ IN



- SE10PWIN
- SE10IWIN
- SE10ESIN
- SE10COIN
- SE10NBIN

- indikátor IN
 - 10 AX 250 V ~, typ SE10
 - v súlade s normou EN 60669-1
 - bezskrútkové upevnenie vodičov 1,5–2,5 mm²

SWITCH 1WAY 10AX 250V~ __ IN
 - IN indicator
 - 10AX 250V~, type SE10
 - in accordance with EN 60669-1
 - plug-in contacts 1.5-2.5mm²



TLAČIDLO JEDNOPÓLOVÉ 10 A 250 V ~



- SE11PW
- SE11IW
- SE11ES
- SE11CO
- SE11NB

- 10 A 250 V ~, typ SE11
 - v súlade s normou EN 60669-1
 - bezskrútkové upevnenie vodičov 1,5–2,5 mm²

PUSH BUTTON 1WAY 10A 250V~
 - 10A 250V~, type SE11
 - in accordance with EN 60669-1
 - plug-in contacts 1.5-2.5mm²



TLAČIDLO JEDNOPÓLOVÉ 10 A 250 V ~ __ TI 50



- SE11PWTI50
- SE11IWTI50
- SE11ESTI50
- SE11COTI50
- SE11NBTI50

- TI 50 indikátor zvonček + tlejivka
 - 10 A 250 V ~, typ SE11
 - v súlade s normou EN 60669-1
 - bezskrútkové upevnenie vodičov 1,5–2,5 mm²

PUSH BUTTON 1WAY 10A 250V~ __ TI 50
 - TI 50 indicator bell+neon lamp
 - 10A 250V~, type SE11
 - in accordance with EN 60669-1
 - plug-in contacts 1.5-2.5mm²



TLAČIDLO JEDNOPÓLOVÉ 10 A 250 V ~ __ TI 51



- SE11PWTI51
- SE11IWTI51
- SE11ESTI51
- SE11COTI51
- SE11NBTI51

- TI 51 indikátor svetlo + tlejivka
 - 10 A 250 V ~, typ SE11
 - v súlade s normou EN 60669-1
 - bezskrútkové upevnenie vodičov 1,5–2,5 mm²

PUSH BUTTON 1WAY 10A 250V~ __ TI 51
 - TI 51 indicator light+neon lamp
 - 10A 250V~, type SE11
 - in accordance with EN 60669-1
 - plug-in contacts 1.5-2.5mm²



TLAČIDLO JEDNOPÓLOVÉ 10 A 250 V ~ __ IL



- SE11PWIL
- SE11IWIL
- SE11ESIL
- SE11COIL
- SE11NBIL

- IL popisný štítok
 - 10 A 250 V ~, typ SE11
 - v súlade s normou EN 60669-1
 - bezskrútkové upevnenie vodičov 1,5–2,5 mm²

PUSH BUTTON 1WAY 10A 250V~ __ IL
 - IL inscription plate
 - 10A 250V~, type SE11
 - in accordance with EN 60669-1
 - plug-in contacts 1.5-2.5mm²



SPÍNAČ DVOJPÓLOVÝ 16 AX 250 V ~ __ IN 03



- SE22PWIN03
- SE22IWIN03
- SE22ESIN03
- SE22NBIN03

- neutrál IN 03 0-1
 - 16 AX 250 V ~, typ SE22
 - v súlade s normou EN 60669-1
 - skrútkové upevnenie vodičov 1,5–2,5 mm²

SWITCH 2POLE 16AX 250V~ __ IN 03
 - IN 03 neutral 0-1
 - 16AX 250V~, type SE22
 - in accordance with EN 60669-1
 - screw contacts 1.5-2.5mm²





- SE50PW
- SE50IW
- SE50ES
- SE50CO
- SE50NB

SPÍNAČ SÉRIOVÝ 10 AX 250 V ~

- 10 AX 250 V ~, typ SE50
- v súlade s normou EN 60669-1
- bezskrútkové upevnenie vodičov 1,5–2,5 mm²

SWITCH 2GANG-1WAY 10AX 250V~

- 10AX 250V~, type SE50
- in accordance with EN 60669-1
- plug-in contacts 1.5-2.5mm²



- SE51PW
- SE51IW
- SE51ES
- SE51CO
- SE51NB

TLAČIDLO SÉRIOVÉ 10 A 250 V ~

- 10 A 250 V ~, typ SE51
- v súlade s normou EN 60669-1
- bezskrútkové upevnenie vodičov 1,5 – 2,5 mm²

PUSH BUTTON 2GANG-1WAY 10A 250V~

- 10A 250V~, type SE51
- in accordance with EN 60669-1
- plug-in contacts 1.5-2.5mm²



- SE52PWNT09
- SE52IWNT09
- SE52ESNT09
- SE52CONT09
- SE52NBNT09

ŽALÚZIOVÝ SPÍNAČ 10 AX 250 V ~ __ NT 09

- NT 09 neutrál hore – dole
- 10 AX 250 V ~, typ SE52
- v súlade s normou EN 60669-1
- bezskrútkové upevnenie vodičov 1,5 – 2,5 mm²
- s mechanickou blokádou súčasného zapnutia

SWITCH SHUTTERS 10AX 250V~ __ NT 09

- NT 09 neutral up-down
- 10AX 250V~, type SE52
- in accordance with EN 60669-1
- plug-in contacts 1.5-2.5mm²
- with mechanical interblock



- SE53PWNT09
- SE53IWNT09
- SE53ESNT09
- SE53CONT09
- SE53NBNT09

ŽALÚZIOVÉ TLAČIDLO 10 A 250 V ~ __ NT 09

- NT 09 neutrál hore – dole
- 10 A 250 V ~, typ SE53
- v súlade s normou EN 60669-1
- bezskrútkové upevnenie vodičov 1,5 – 2,5 mm²
- s mechanickou blokádou súčasného zapnutia

PUSH BUTTON SHUTTERS 10A 250V~ __ NT 09

- NT 09 neutral up-down
- 10A 250V~, type SE53
- in accordance with EN 60669-1
- plug-in contacts 1.5-2.5mm²
- with mechanical interblock



- SE60PW
- SE60IW
- SE60ES
- SE60CO
- SE60NB

STRIEDAVÝ PREPÍNAČ 10 AX 250 V ~

- 10 AX 250 V ~, typ SE60
- v súlade s normou EN 60669-1
- bezskrútkové upevnenie vodičov 1,5 – 2,5 mm²

SWITCH 2WAY 10AX 250V~

- 10AX 250V~, type SE60
- in accordance with EN 60669-1
- plug-in contacts 1.5-2.5mm²



- SE63PW
- SE63IW
- SE63ES
- SE63CO
- SE63NB

STRIEDAVÝ PREPÍNAČ DVOJITÝ 10 AX 250 V ~

- 10 AX 250 V ~, typ SE63
- v súlade s normou EN 60669-1
- bezskrútkové upevnenie vodičov 1,5 – 2,5 mm²

SWITCH DOUBLE 2WAY 10AX 250V~

- 10AX 250V~, type SE63
- in accordance with EN 60669-1
- plug-in contacts 1.5-2.5mm²



- SE70PW
- SE70IW
- SE70ES
- SE70CO
- SE70NB

KRÍŽOVÝ PREPÍNAČ 10 AX 250 V ~

- 10 AX 250 V ~, typ SE70
- v súlade s normou EN 60669-1
- bezskrútkové upevnenie vodičov 1,5 – 2,5 mm²

SWITCH INTERMEDIATE 10AX 250V~

- 10AX 250V~, type SE70
- in accordance with EN 60669-1
- plug-in contacts 1.5-2.5mm²

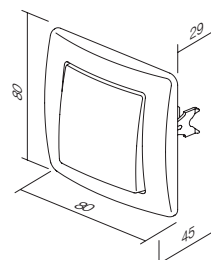
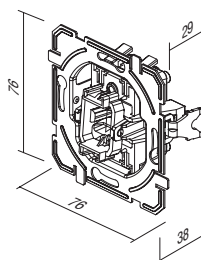

K R Y T Y T L A Č I D I E L T E









TE11

PW

NT

09

typ type	popis description	farba colour	voliteľné údaje 1 optional data 1	voliteľné údaje 2 optional data 2
TE10	KRYT TLAČIDLA BUTTON 1GANG	<input type="checkbox"/> PW polárna biela polar white <input type="checkbox"/> IW slonová kosť ivory white <input type="checkbox"/> ES strieborná matná elox silver <input type="checkbox"/> CO biely duroplast white thermoset <input type="checkbox"/> NB čierna lesklá night black	 NT neutrálna neutral  IN indikátor indicator	 50  51  03  04
TE11	KRYT TLAČIDLA BUTTON 2GANG			

KRYT TLAČIDLA



- TE10PW
- TE10IW
- TE10ES
- TE10CO
- TE10NB

- kryt tlačidla s kolískou
BUTTON 1GANG
- button together with carrier



KRYT TLAČIDLA S INDIKÁTOROM

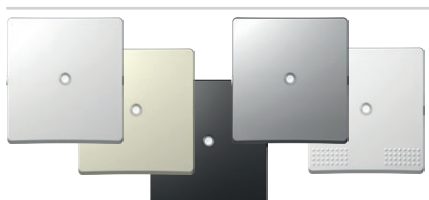

- TE10PWIN
- TE10IWIN
- TE10ESIN
- TE10COIN
- TE10NBIN

- kryt tlačidla s kolískou
BUTTON INDICATOR
- button together with carrier



KRYT TLAČIDLA S POPISNÝM ŠTÍTKOM

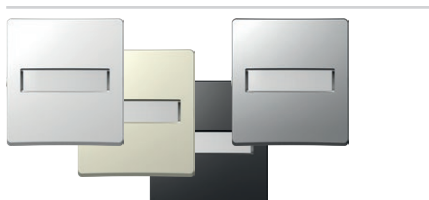

- TE13PWIL
- TE13IWIL
- TE13ESIL
- TE13NBIL

- kryt tlačidla s kolískou a popisným štítkom
BUTTON WITH INSCRIPTION PLATE
- button together with carrier, with inscription plate



KRYT DVOJITÉHO TLAČIDLA



- TE11PW
- TE11IW
- TE11ES
- TE11CO
- TE11NB

- kryt dvojitého tlačidla s kolískou
BUTTON 2GANG
- button 2gang together with carrier

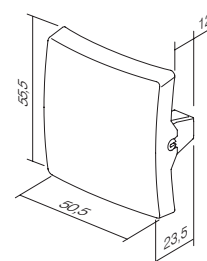
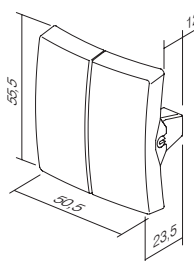

S I G N A L I Z A T I O N I A

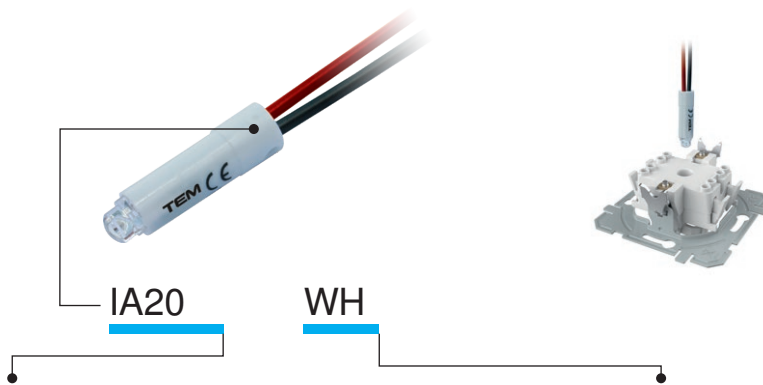

typ type	popis description	technické dáta technical data	farba colour
IA10	TLEJIVKA NEON LAMP	230V~ 0,34W	<input type="checkbox"/> WH biela white
IA20	LED SIGNALIZÁCIA LED SIGNALLING UNIT	230V~ 0,40W	<input checked="" type="checkbox"/> BL modrá blue
IA21	LED SIGNALIZÁCIA LED SIGNALLING UNIT	24V AC/DC 0,20W	<input checked="" type="checkbox"/> RD červená red
·	·	·	<input checked="" type="checkbox"/> GR zelená green
·	·	·	<input checked="" type="checkbox"/> OR oranžová orange

TLEJIVKA 230 V ~ 0,34 W

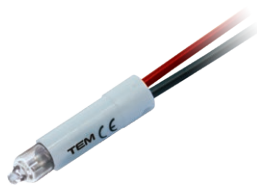
 IA10OR

- na indikáciu, signalizáciu alebo trvalú signalizáciu
- v kombinácii s tlačidlom s indikátorom

NEON LAMP 230V~ 0,34W

- for indication, signalling or permanent signalling
- in combination with a button featuring an indicator

LED SIGNALIZÁCIA 230 V AC/DC 0,40 W

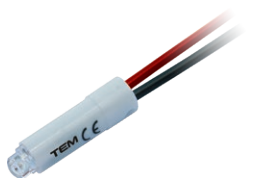

IA20WH
 IA20GR
 IA20RD
 IA20BL

- na indikáciu, signalizáciu alebo trvalú signalizáciu
- v kombinácii s tlačidlom s indikátorom

LED SIGNALLING UNIT 230V AC/DC 0,40W

- for indication, signalling or permanent signalling
- in combination with a button featuring an indicator

LED SIGNALIZÁCIA 24 V AC/DC 0,20 W

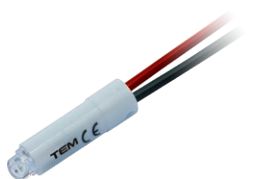

IA21WH
 IA21RD

- na indikáciu, signalizáciu alebo trvalú signalizáciu
- v kombinácii s tlačidlom s indikátorom

LED SIGNALLING UNIT 24V AC/DC 0,20W

- for indication, signalling or permanent signalling
- in combination with a button featuring an indicator

LED SIGNALIZÁCIA 12 V AC/DC 0,10 W

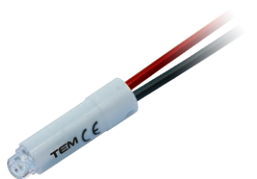

IA22WH
 IA22RD

- na indikáciu, signalizáciu alebo trvalú signalizáciu
- v kombinácii s tlačidlom s indikátorom

LED SIGNALLING UNIT 12V AC/DC 0,10W

- for indication, signalling or permanent signalling
- in combination with a button featuring an indicator

Indikácia /
Indication

* Signalizácia /
Signalization

Trvalá signalizácia /
Permanent signalling

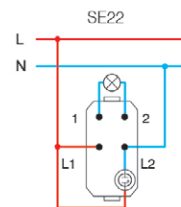
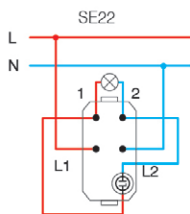
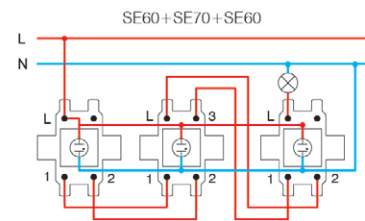
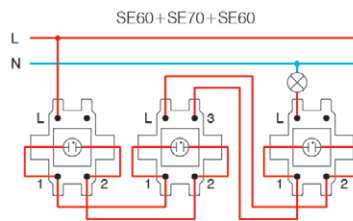
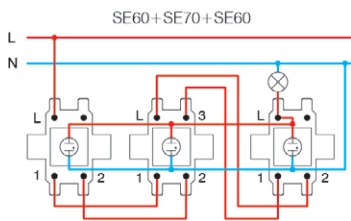
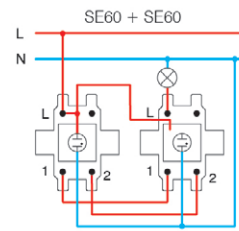
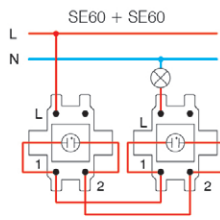
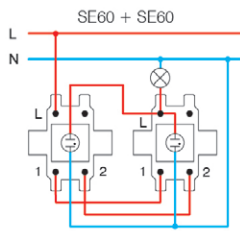
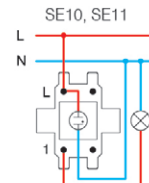
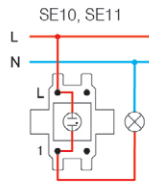
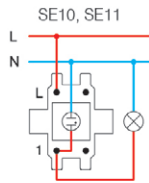

* pripojenia nie sú vhodné pre úsporné žiarivky (CFL, LED) /
the connections are not suitable for energy-saving bulbs (CFL, LED)

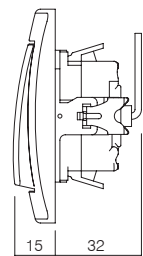

S O C K E T S V E



VE11



PT

XO

KS



typ type	popis description	technické dáta technical data	voliteľné údaje 1 optional data 1	voliteľné údaje 2 optional data 2
VE10	ZÁSUVKA SCHUKO SOCKET SCHUKO	2P+E 16A 250V~	XO bez rámečka without cover plate	KS zabudovaná ochrana pred dotykom s kontaktnými pod napätím shuttered live contacts
VE11	ZÁSUVKA SCHUKO + KRYT SOCKET SCHUKO+COVER	2P+E 16A 250V~		
VE12	ZÁSUVKA SCHUKO SOCKET SCHUKO	2P+E 16A 250V~ BV	KS zabudovaná ochrana pred dotykom s kontaktnými pod napätím shuttered live contacts	
⋮	⋮	⋮		

farba
colour

<input type="checkbox"/> PW	polárna biela polar white	<input checked="" type="checkbox"/> PT	biela + transparentná white+transparent	<input type="checkbox"/> PP	biela + biela white+white
<input checked="" type="checkbox"/> IW	slonová kosť ivory white	<input checked="" type="checkbox"/> IT	slonová kosť + transparentná ivory+transparent	<input checked="" type="checkbox"/> II	slonová kosť + slonová kosť ivory+ivory
<input type="checkbox"/> ES	strieborná matná elox silver	<input checked="" type="checkbox"/> ST	strieborná matná + transparentná silver+transparent	<input type="checkbox"/> SS	strieborná matná + strieborná matná silver+silver
<input type="checkbox"/> CO	biely duroplast white thermoset	<input checked="" type="checkbox"/> CT	biely duroplast + transparentná white+transparent	<input checked="" type="checkbox"/> BB	čierna lesklá + čierna lesklá black+black
<input checked="" type="checkbox"/> NB	čierna matná night black	<input checked="" type="checkbox"/> BT	čierna matná + transparentná black+transparent	<input checked="" type="checkbox"/> RR	červená + červená red+red
<input checked="" type="checkbox"/> RD	červená red	<input checked="" type="checkbox"/> RT	červená + transparentná red+transparent	<input checked="" type="checkbox"/> GG	zelená + zelená green+green
<input checked="" type="checkbox"/> GR	zelená green	<input checked="" type="checkbox"/> GT	zelená + transparentná green+transparent	<input checked="" type="checkbox"/> OO	oranžová + oranžová orange+orange
<input checked="" type="checkbox"/> OR	oranžová orange	<input checked="" type="checkbox"/> OT	oranžová + transparentná orange+transparent		



schuko – vyhovuje EN 60884-1, CEE7 (list III)

Francúzsko – vyhovuje NF C 61-314 (list V)

schuko - in accordance with EN 60884-1, CEE7 (standard sheet III)

French - in accordance with NF C 61-314 (standard sheet V)

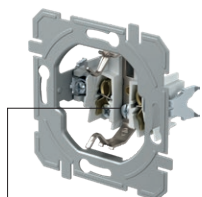
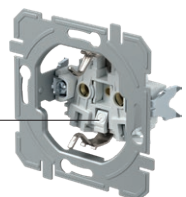
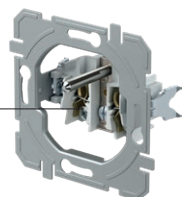
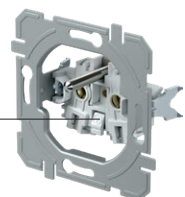
skrutkové upevnenie vodičov
screw contactsBV bezskrutkové upevnenie vodičov
BV plug-in contactsskrutkové upevnenie vodičov
screw contactsBV bezskrutkové upevnenie vodičov
BV plug-in contacts

ZÁSUVKA SCHUKO 2P+E 16 A 250 V ~ __ XO

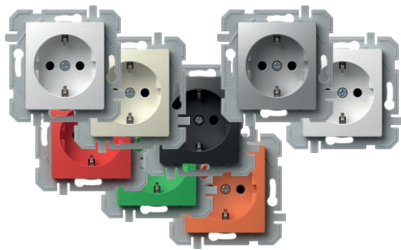

- VE10PWXO
- VE10IWXO
- VE10ESXO
- VE10COXO
- VE10NBXO
- VE10RDXO
- VE10GRXO
- VE10ORXO

- skrutkové upevnenie vodičov 1,5 – 2,5 mm²
- XO bez rámečka
- 2P+E schuko
- 16A 250 V ~, typ VE10

SOCKET SCHUKO 2P+E 16A 250V~ __ XO

- screw contacts 1.5-2.5mm²
- XO without surround
- 2P+E schuko
- 16A 250V~, type VE10



ZÁSUVKA SCHUKO + KRYT 2P+E 16 A 250 V ~ __ XO

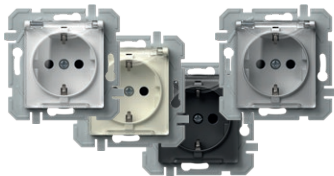

- VE11PTXO
- VE11ITXO
- VE11STXO
- VE11BTXO

- skrutkové upevnenie vodičov 1,5 – 2,5 mm²
- XO bez rámečka
- 2P + E schuko + kryt
- 16A 250 V ~, typ VE11

SOCKET SCHUKO+COVER 2P+E 16A 250V~ __ XO

- screw contacts 1.5-2.5mm²
- XO without surround
- 2P+E schuko+cover
- 16A 250V~, type VE11



ZÁSUVKA SCHUKO 2P+E 16 A 250 V ~ BV __ XO



- VE12PWXO
- VE12IWXO
- VE12ESXO
- VE12COXO
- VE12NBXO
- VE12RDXO
- VE12GRXO
- VE12ORXO

- BV bezskrutkové upevnenie vodičov 1,5 – 2,5 mm²
- XO bez rámečka
- 2P+E schuko
- 16A 250 V ~, typ VE12

SOCKET SCHUKO 2P+E 16A 250V~ BV __ XO

- BV plug-in contacts 1.5-2.5mm²
- XO without surround
- 2P+E schuko
- 16A 250V~, type VE12



ZÁSUVKA SCHUKO + KRYT 2P+E 16 A 250 V ~ BV __ XO

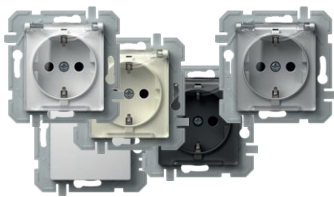

- VE13PTXO
- VE13ITXO
- VE13STXO
- VE13BTXO
- VE13PPXO

- BV bezskrutkové upevnenie vodičov 1,5 – 2,5 mm²
- XO bez rámečka
- 2P + E schuko + kryt
- 16A 250 V ~, typ VE13

SOCKET SCHUKO+COVER 2P+E 16A 250V~ BV __ XO

- BV plug-in contacts 1.5-2.5mm²
- XO without surround
- 2P+E schuko+cover
- 16A 250V~, type VE13



ZÁSUVKA SCHUKO 2P+E 16 A 250 V ~



- VE10PW
- VE10IW
- VE10ES
- VE10CO
- VE10NB

- skrutkové upevnenie vodičov 1,5 – 2,5 mm²
- 2P+E schuko
- 16A 250 V ~, typ VE10

SOCKET SCHUKO 2P+E 16A 250V~

- screw contacts 1.5-2.5mm²
- 2P+E schuko
- 16A 250V~, type VE10



ZÁSUVKA SCHUKO + kryt 2P+E 16 A 250 V ~



- VE11PT
- VE11IT
- VE11ST
- VE11CT
- VE11BT

- skrutkové upevnenie vodičov 1,5 – 2,5 mm²
- 2P + E schuko + kryt
- 16A 250 V ~, typ VE11

SOCKET SCHUKO+COVER 2P+E 16A 250V~

- screw contacts 1.5-2.5mm²
- 2P+E schuko+cover
- 16A 250V~, type VE11



ZÁSUVKA SCHUKO 2P+E 16A 250V~ BV



- VE12PW
- VE12IW
- VE12ES
- VE12CO
- VE12NB

- BV bezskrutkové upevnenie vodičov 1,5 – 2,5 mm²
- 2P+E schuko
- 16A 250 V ~, typ VE12

SOCKET SCHUKO 2P+E 16A 250V~ BV

- BV plug-in contacts 1.5-2.5mm²
- 2P+E schuko
- 16A 250V~, type VE12



ZÁSUVKA SCHUKO + KRYT 2P+E 16 A 250 V ~ BV



- VE13PT
- VE13IT
- VE13ST
- VE13CT
- VE13BT

- BV bezskrutkové upevnenie vodičov 1,5 – 2,5 mm²
- 2P + E schuko + kryt
- 16A 250 V ~, typ VE13

SOCKET SCHUKO+COVER 2P+E 16A 250V~ BV

- BV plug-in contacts 1.5-2.5mm²
- 2P+E schuko+cover
- 16A 250V~, type VE13



S O C K E T S V E

FRANCÚZSKA ZÁSUVKA 2P+E 16 A 250 V ~ __ XO

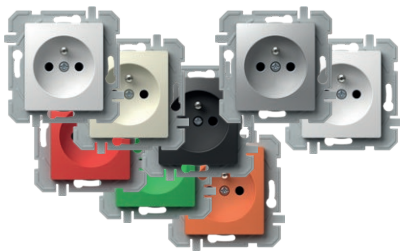

- VE40PWXO
- VE40IWXO
- VE40ESXO
- VE40COXO
- VE40NBXO
- VE40RDXO
- VE40GRXO
- VE40ORXO

- skrutkové upevnenie vodičov 1,5 – 2,5 mm²
- XO bez rámečka
- 2P+E francúzska
- 16A 250 V ~, typ VE40

SOCKET FRENCH 2P+E 16A 250V~ __ XO

- screw contacts 1.5-2.5mm²
- XO without surround
- 2P+E French
- 16A 250V~, type VE40



FRANCÚZSKA ZÁSUVKA + KRYT 2P+E 16 A 250 V ~ __ XO

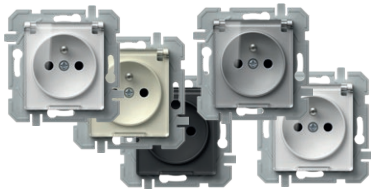

- VE41PTXO
- VE41ITXO
- VE41STXO
- VE41BTXO

- skrutkové upevnenie vodičov 1,5 – 2,5 mm²
- XO bez rámečka
- 2P+E francúzska + kryt
- 16A 250 V ~, typ VE41

SOCKET FRENCH+COVER 2P+E 16A 250V~ __ XO

- screw contacts 1.5-2.5mm²
- XO without surround
- 2P+E French+cover
- 16A 250V~, type VE41



FRANCÚZSKA ZÁSUVKA 2P+E 16 A 250 V ~ BV __ XO

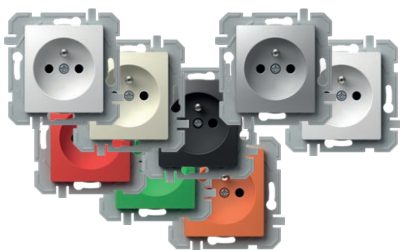

- VE42PWXO
- VE42IWXO
- VE42ESXO
- VE42COXO
- VE42NBXO
- VE42RDXO
- VE42GRXO
- VE42ORXO

- BV bezskrutkové upevnenie vodičov 1,5 – 2,5 mm²
- XO bez rámečka
- 2P+E francúzska
- 16A 250 V ~, typ VE42

SOCKET FRENCH 2P+E 16A 250V~ BV __ XO

- BV plug-in contacts 1.5-2.5mm²
- XO without surround
- 2P+E French
- 16A 250V~, type VE42



FRANCÚZSKA ZÁSUVKA + KRYT 2P+E 16 A 250 V ~ BV __ XO



- VE43PTXO
- VE43ITXO
- VE43STXO
- VE43BTXO

- BV bezskrutkové upevnenie vodičov 1,5 – 2,5 mm²
- XO bez rámečka
- 2P+E francúzska + kryt
- 16A 250 V ~, typ VE43

SOCKET FRENCH+COVER 2P+E 16A 250V~ BV __ XO

- BV plug-in contacts 1.5-2.5mm²
- XO without surround
- 2P+E French+cover
- 16A 250V~, type VE43



FRANCÚZSKA ZÁSUVKA 2P+E 16 A 250 V ~



- VE40PW
- VE40IW
- VE40ES
- VE40CO
- VE40NB

- skrutkové upevnenie vodičov 1,5 – 2,5 mm²
- 2P+E francúzska
- 16A 250 V ~, typ VE40

SOCKET FRENCH 2P+E 16A 250V~

- screw contacts 1.5-2.5mm²
- 2P+E French
- 16A 250V~, type VE40



FRANCÚZSKA ZÁSUVKA + KRYT 2P+E 16 A 250 V ~



- VE41PT
- VE41IT
- VE41BT
- VE41ST

- skrutkové upevnenie vodičov 1,5 – 2,5 mm²
- 2P+E francúzska + kryt
- 16A 250 V ~, typ VE41

SOCKET FRENCH+COVER 2P+E 16A 250V~

- screw contacts 1.5-2.5mm²
- 2P+E French+cover
- 16A 250V~, type VE41



FRANCÚZSKA ZÁSUVKA 2P+E 16 A 250 V ~ BV



- VE42PW
- VE42IW
- VE42ES
- VE42CO
- VE42NB

- BV bezskrutkové upevnenie vodičov 1,5 – 2,5 mm²
- 2P+E francúzska
- 16A 250 V ~, typ VE42

SOCKET FRENCH 2P+E 16A 250V~ BV

- BV plug-in contacts 1.5-2.5mm²
- 2P+E French
- 16A 250V~, type VE42



FRANCÚZSKA ZÁSUVKA + KRYT 2P+E 16 A 250 V ~ BV



- VE43PT
- VE43IT
- VE43BT
- VE43ST

- BV bezskrutkové upevnenie vodičov 1,5 – 2,5 mm²
- 2P+E francúzska + kryt
- 16A 250 V ~, typ VE43

SOCKET FRENCH+COVER 2P+E 16A 250V~ BV

- BV plug-in contacts 1.5-2.5mm²
- 2P+E French+cover
- 16A 250V~, type VE43



ZÁSUVKA SCHUKO DVOJITÁ 2P+E 16 A 250 V ~



- VE16PWKS
- VE16IWKS
- VE16ESKS
- VE16NBKS

- 2P+E schuko dvojité
- 16A 250 V ~, typ VE16
- v súlade s normou IEC 60884-1, CEE7
- skrutkové upevnenie vodičov 1,5 – 2,5 mm²
- zabudovaná ochrana pred dotykom s kontaktní pod napätím

SOCKET SCHUKO DOUBLE 2P+E 16A 250V~

- 2P+E schuko double
- 16A 250V~, type VE16
- in accordance with IEC 60884-1, CEE7
- screw contacts 1.5-2.5 mm²
- shuttered live contacts



FRANCÚZSKA ZÁSUVKA DVOJITÁ 2P+E 16 A 250 V ~



- VE46PWKS
- VE46IWKS
- VE46ESKS
- VE46NBKS

- 2P+E francúzska dvojité
- 16A 250 V ~, typ VE46
- v súlade s normami IEC 60884-1, CEE7, NF C 61-314, ČSN 33 2318 a PN-E 93201
- skrutkové upevnenie vodičov 1,5 – 2,5 mm²
- zabudovaná ochrana pred dotykom s kontaktní pod napätím

SOCKET FRENCH DOUBLE 2P+E 16A 250V~

- 2P+E French double
- 16A 250V~, type VE46
- in accordance with IEC 60884-1, CEE7; NF C 61-314, ČSN 33 2318; PN-E 93201
- screw contacts 1,5-2,5 mm²
- shuttered live contacts



ZÁSUVKA 2P 16A 250V~



- VE30PW
- VE30IW
- VE30ES
- VE30NB

- 2P bez uzemňovacieho kontaktu
- 16A 250V ~
- v súlade s normou EN 60884-1, CEE7 (list I)
- skrutkové upevnenie vodičov 1,5 – 2,5 mm²

SOCKET 2P 16A 250V~

- 2P without earthing contact
- 16A 250V~
- in accordance with EN 60884-1, CEE7 (standard sheet I)
- screw contacts 1.5-2.5mm²

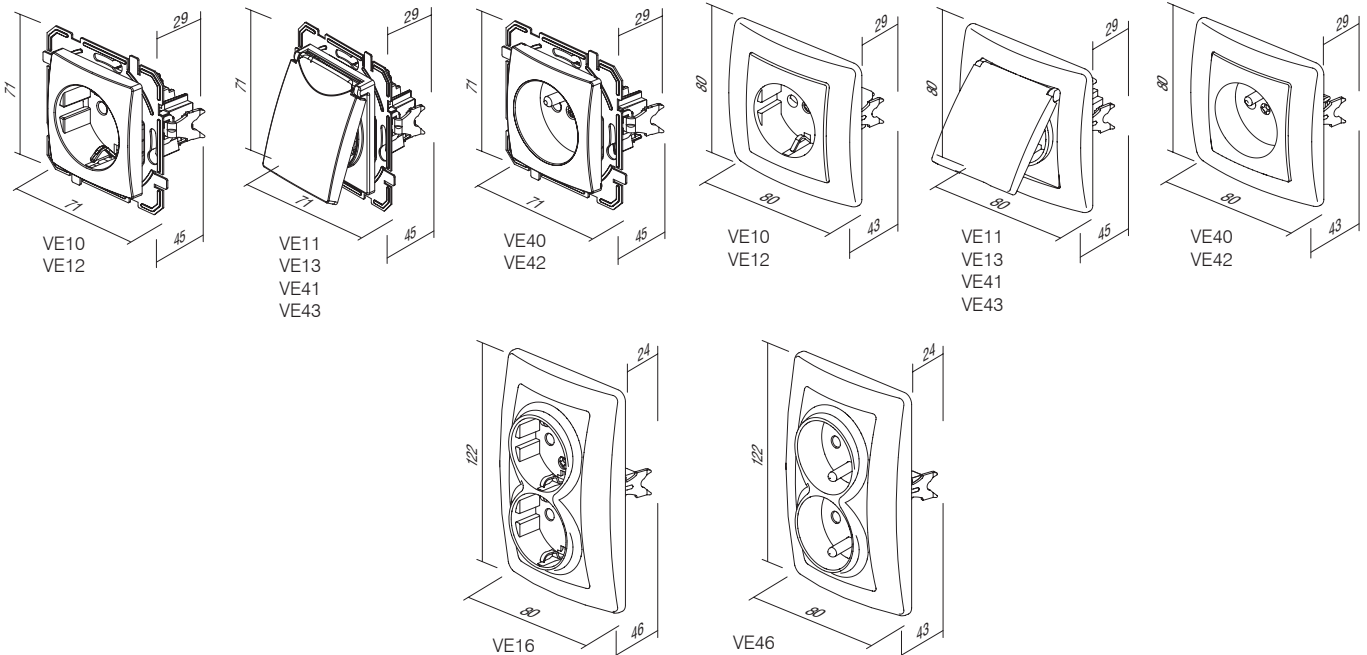



KE37

PW

typ type	popis description	technické dáta technical data	farba colour
KE11	ZÁSUVKA TV-R KONCOVÁ SOCKET TV-R END-LINE	1dB	<input type="checkbox"/> PW polárna biela polar white
KE12	ZÁSUVKA TV-R PRIEBEŽNÁ SOCKET TV-R THROUGHPASS	10dB	<input type="checkbox"/> IW slonová košť ivory white
KE16	ZÁSUVKA SAT-TV-R KONCOVÁ SOCKET SAT-TV-R END-LINE	3dB	<input type="checkbox"/> ES strieborná matná elox silver
⋮	⋮	⋮	<input type="checkbox"/> CO biely duroplast white thermoset
⋮	⋮	⋮	<input type="checkbox"/> NB čierna lesklá night black

ZÁSUVKA TV-R KONCOVÁ 1 dB



KE11

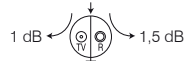

- TV-R koncová
- frekvenčné pásmo 5 ÷ 862MHz
- útlm: R – 1,5 dB, TV – 1 dB
- v súlade s normou EN 50083-1
- skrutkové upevnenie vodičov

SOCKET TV-R END-LINE 1dB

- TV-R end-line
- frequency range 5÷862MHz
- reduction: R-1.5dB, TV-1dB
- in accordance with EN 50083-1
- screw contacts

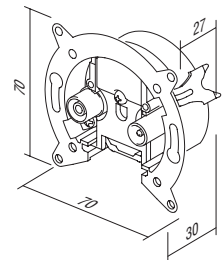

ZÁSUVKA TV-R PRIEBEŽNÁ 10 dB



KE12

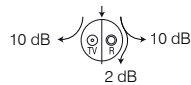

- TV-R priebežná zásuvka
- frekvenčné pásmo 5 ÷ 862MHz
- útlm: R – 10dB, TV – 10dB, prechod – 2 dB
- v súlade s normou EN 50083-1
- skrutkové upevnenie vodičov

SOCKET TV-R TROUGHPASS 10dB

- TV-R troughpass
- frequency range 5÷862MHz
- reduction: R-10dB, TV-10dB, trough-2dB
- in accordance with EN 50083-1
- screw contacts

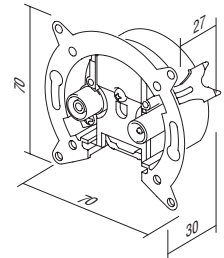

ZÁSUVKA SAT-TV-R KONCOVÁ 3 dB



KE16

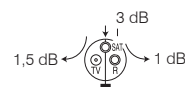

- SAT-TV-R koncová
- frekvenčné pásmo 5 ÷ 2400MHz
- útlm: R – 1 dB, TV – 1,5 dB, SAT – 3 dB
- montáž do krabice Ø 60 svorkami alebo skrutkami
- v súlade s normou EN 50083-1
- skrutkové upevnenie vodičov

SOCKET SAT-TV-R END-LINE 3dB

- SAT-TV-R end-line
- frequency range 5÷2400MHz
- reduction: R-1dB, TV-1.5dB, SAT-3dB
- for mounting in round box Ø60 with claws or screws
- in accordance with EN 50083-1
- screw contacts

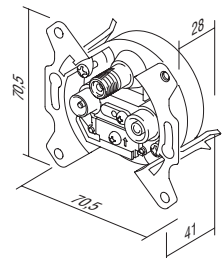

ZÁSUVKA TEL KS RJ11 6/4

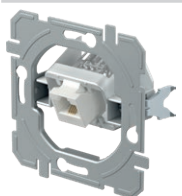

KE36

- KS keystone štandard upevnenia
- RJ11 6/4
- v súlade s normou IEC 60603-7

SOCKET TEL KS RJ11 6/4

- KS keystone fixing standard
- RJ11 6/4
- in accordance with IEC 60603-7

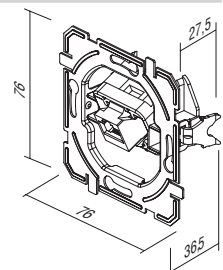

ZÁSUVKA KAT. 5e KS RJ45 8/8

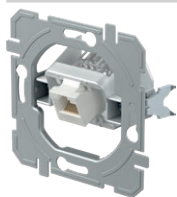

KE37

- KS keystone štandard upevnenia
- KAT. 5e, RJ45 8/8
- v súlade s normou IEC 60603-7

SOCKET CAT5e KS RJ45 8/8
 - KS keystone fixing standard
 - CAT5e, RJ45 8/8
 - in accordance with IEC 60603-7

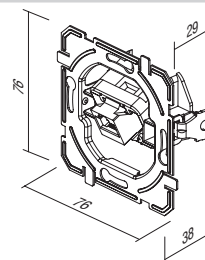

ZÁSUVKA KAT. 6s KS RJ45 8/8 SLIM

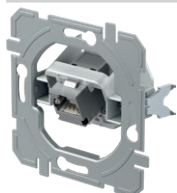

KE40

- KS keystone štandard upevnenia
- KAT. 6s, RJ45 8/8
- v súlade s normou IEC 60603-7

SOCKET CAT6s KS RJ45 8/8 SLIM
 - KS keystone fixing standard
 - CAT6s, RJ45 8/8
 - in accordance with IEC 60603-7

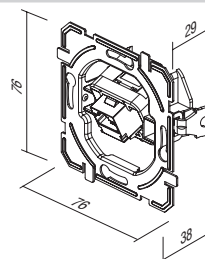

ZÁSUVKA TEL KS DVOJITÁ 2 x RJ11 6/4

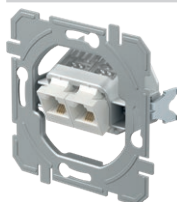

KE38

- KS keystone štandard upevnenia
- 2 x RJ11 6/4
- v súlade s normou IEC 60603-7

SOCKET TEL KS DOUBLE 2x RJ11 6/4
 - KS keystone fixing standard
 - 2x RJ11 6/4
 - in accordance with IEC 60603-7

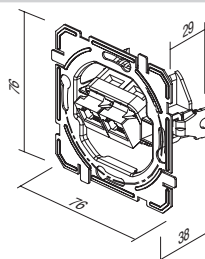

ZÁSUVKA KAT. 5e KS DVOJITÁ 2 x RJ45 8/8

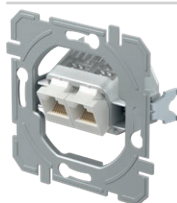

KE39

- KS keystone štandard upevnenia
- 2 x KAT. 5e, RJ45 8/8
- v súlade s normou IEC 60603-7

SOCKET CAT5e KS DOUBLE 2x RJ45 8/8
 - KS keystone fixing standard
 - 2x CAT5e, RJ45 8/8
 - in accordance with IEC 60603-7

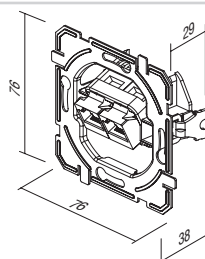

ZÁSUVKA KAT. 6s KS DVOJITÁ 2 x RJ45 8/8 SLIM



KE41

- KS keystone štandard upevnenia
- 2 x KAT. 6s, RJ45 8/8
- v súlade s normou IEC 60603-7

SOCKET CAT6s KS DOUBLE 2x RJ45 8/8 SLIM
 - KS keystone fixing standard
 - 2x CAT6s, RJ45 8/8
 - in accordance with IEC 60603-7

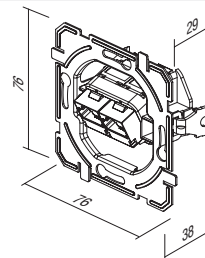

ADAPTÉR KS SAMOSTATNÝ

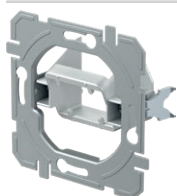

KE45

- keystone KS štandard pripojenia – samostatný
- AMP, Avaya, Brandrex, FMT, Mfico, Tyco, ...
- komunikačný modul nie je súčasťou dodávky

ADAPTER KS SINGLE
 - KS keystone fixing standard - single
 - AMP, Avaya, Brandrex, FMT, Mfico, Tyco, ...
 - communication module not included

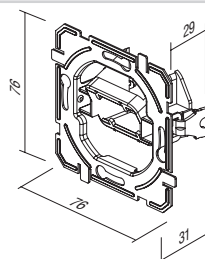

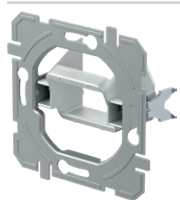

KE46

ADAPTÉR KS DVOJITÝ

- keystone KS štandard pripojenia – dvojitý
- AMP, Tyco, ...
- komunikačný modul nie je súčasťou dodávky

ADAPTER KS DOUBLE

- KS keystone fixing standard - double
- AMP, Tyco, ...
- communication module not included

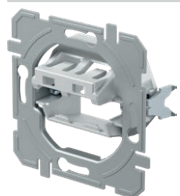
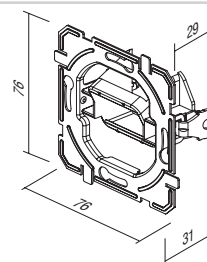

KE47

ADAPTÉR PD DVOJITÝ

- štandard upevnenia PD Panduit Mini-COM – dvojitý
- komunikačný modul nie je súčasťou dodávky

ADAPTER PD DOUBLE

- PD Panduit Mini-COM fixing standard - double
- communication module not included

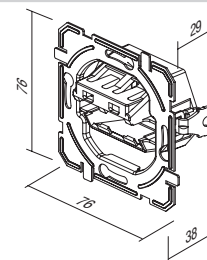

ZÁSUVKA TV ZÁKLADNÁ 0dB



- KE10PW
- KE10IW
- KE10ES
- KE10CO
- KE10NB

- TV základná
- útlm 0 dB
- zadný konektor – F štandard

SOCKET TV BASIC 0dB

- TV basic
- reduction 0dB
- back connector – F standard



ZÁSUVKA TV-R KONCOVÁ 1 dB



- KE11PW
- KE11IW
- KE11ES
- KE11CO
- KE11NB

- TV-R koncová
- frekvenčné pásmo 5 ÷ 862MHz
- útlm: R – 1,5 dB, TV – 1 dB
- v súlade s normou EN 50083-1
- skrutkové upevnenie vodičov

SOCKET TV-R END-LINE 1dB

- TV-R end-line
- frequency range 5÷862 MHz
- reduction: R-1.5dB, TV-1dB
- in accordance with EN 50083-1
- screw contact



ZÁSUVKA TV-R PRIEBEŽNÁ 10 dB



- KE12PW
- KE12IW
- KE12ES
- KE12CO
- KE12NB

- TV-R priebežná zásuvka
- frekvenčné pásmo 5 ÷ 862MHz
- útlm: R – 10dB, TV – 10dB, prechod – 2 dB
- v súlade s normou EN 50083-1
- skrutkové upevnenie vodičov

SOCKET TV-R TROUGH-PASS 10dB

- TV-R troughpass
- frequency range 5÷862 MHz
- reduction: R-10dB, TV-10dB, trough-2dB
- in accordance with EN 50083-1
- screw contacts



ZÁSUVKA SAT-TV-R KONCOVÁ 3 dB



- KE16PW
- KE16IW
- KE16ES
- KE16CO
- KE16NB

- SAT-TV-R koncová
- frekvenčné pásmo 5 ÷ 2400 MHz
- útlm: R – 1 dB, TV – 1,5 dB, SAT – 3 dB
- v súlade s normou EN 50083-1
- skrutkové upevnenie vodičov

SOCKET SAT-TV-R END-LINE 3dB

- SAT-TV-R end-line
- frequency range 5÷2400 MHz
- reduction: R-1dB, TV-1.5dB, SAT-3dB
- in accordance with EN 50083-1
- screw contacts



AUDIO ZÁSUVKA 2xRCA



- KE22PW
- KE22IW
- KE22ES
- KE22CO
- KE22NB

- audio 2 x RCA
- upevnenie vodičov spájkovaním

SOCKET AUDIO 2xRCA

- audio 2xRCA
- soldering connection of cable



ZÁSUVKA AUDIO REPRODUKTOROVÁ



- KE23PW
- KE23IW
- KE23ES
- KE23CO
- KE23NB

- audio 2 x Ø 4 mm
- na pripojenie reproduktorového vodiča, banánovej zástrčky Ø 4 mm alebo vidlicovej káblovej pätky
- upevnenie vodičov vzadu spájkovaním

SOCKET AUDIO LOUDSPEAKERS

- audio 2x Ø4mm
- to accommodate speaker wire, banana plug Ø4mm or spades
- soldering connection of cable at the back side



ZÁSUVKA TEL KS RJ11 6/4

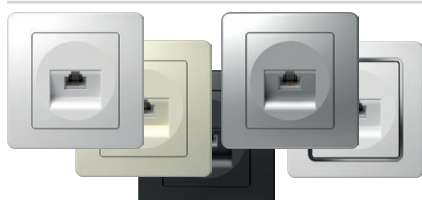

- KE36PW
- KE36IW
- KE36ES
- KE36CO
- KE36NB

- KS keystone štandard upevnenia
- RJ11 6/4
- v súlade s normou IEC 60603-7

SOCKET TEL KS RJ11 6/4

- KS keystone fixing standard
- RJ11 6/4
- in accordance with IEC 60603-7





- KE37PW
- KE37IW
- KE37ES
- KE37CO
- KE37NB

ZÁSUVKA KAT. 5e KS RJ45 8/8

- KS keystone štandard upevnenia
- KAT. 5e, RJ45 8/8
- v súlade s normou IEC 60603-7

SOCKET CAT5e KS RJ45 8/8

- KS keystone fixing standard
- CAT5e, RJ45 8/8
- in accordance with IEC 60603-7

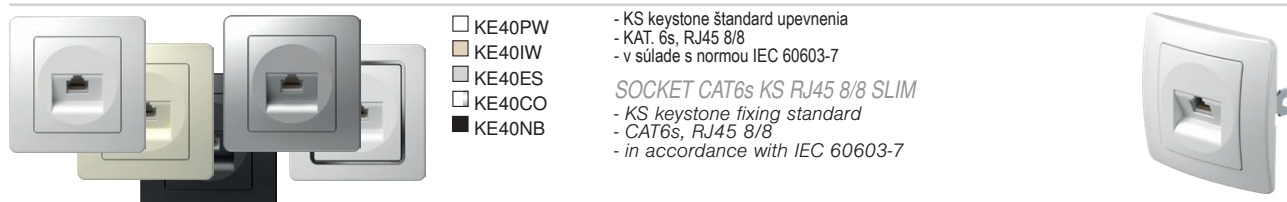

- KE40PW
- KE40IW
- KE40ES
- KE40CO
- KE40NB

ZÁSUVKA KAT. 6s KS RJ45 8/8 SLIM

- KS keystone štandard upevnenia
- KAT. 6s, RJ45 8/8
- v súlade s normou IEC 60603-7

SOCKET CAT6s KS RJ45 8/8 SLIM

- KS keystone fixing standard
- CAT6s, RJ45 8/8
- in accordance with IEC 60603-7

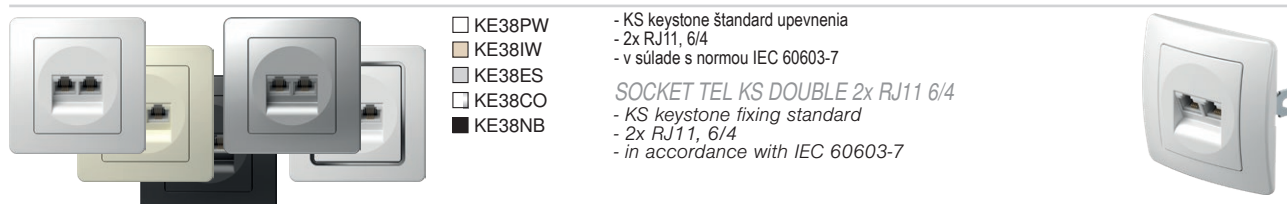

- KE38PW
- KE38IW
- KE38ES
- KE38CO
- KE38NB

ZÁSUVKA TEL KS DVOJITÁ 2 x RJ11 6/4

- KS keystone štandard upevnenia
- 2x RJ11, 6/4
- v súlade s normou IEC 60603-7

SOCKET TEL KS DOUBLE 2x RJ11 6/4

- KS keystone fixing standard
- 2x RJ11, 6/4
- in accordance with IEC 60603-7

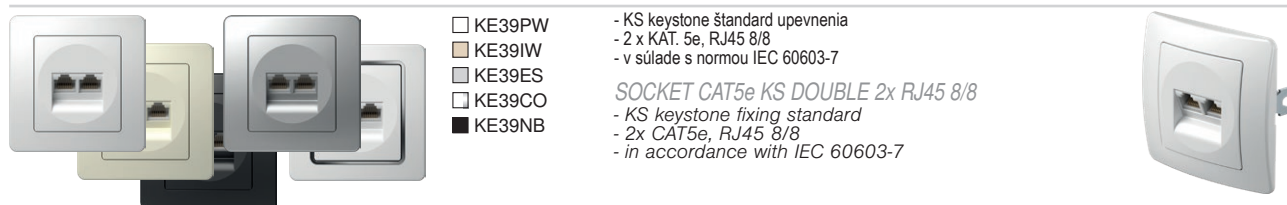

- KE39PW
- KE39IW
- KE39ES
- KE39CO
- KE39NB

ZÁSUVKA KAT. 5e KS DVOJITÁ 2 x RJ45 8/8

- KS keystone štandard upevnenia
- 2 x KAT. 5e, RJ45 8/8
- v súlade s normou IEC 60603-7

SOCKET CAT5e KS DOUBLE 2x RJ45 8/8

- KS keystone fixing standard
- 2x CAT5e, RJ45 8/8
- in accordance with IEC 60603-7

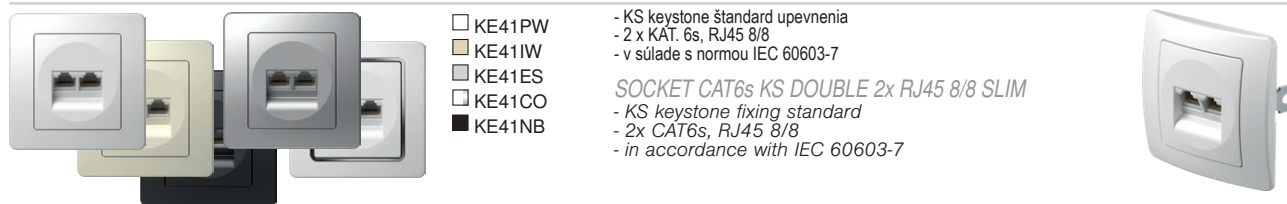

- KE41PW
- KE41IW
- KE41ES
- KE41CO
- KE41NB

ZÁSUVKA KAT. 6s KS DVOJITÁ 2 x RJ45 8/8 SLIM

- KS keystone štandard upevnenia
- 2 x KAT. 6s, RJ45 8/8
- v súlade s normou IEC 60603-7

SOCKET CAT6s KS DOUBLE 2x RJ45 8/8 SLIM

- KS keystone fixing standard
- 2x CAT6s, RJ45 8/8
- in accordance with IEC 60603-7

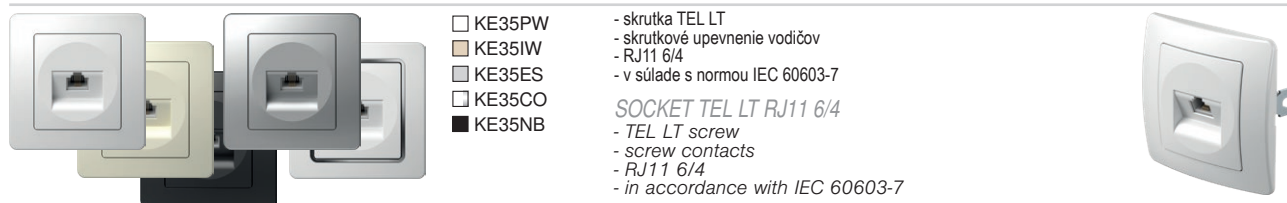

- KE35PW
- KE35IW
- KE35ES
- KE35CO
- KE35NB

ZÁSUVKA TEL LT RJ11 6/4

- skrutka TEL LT
- skrutkové upevnenie vodičov
- RJ11 6/4
- v súlade s normou IEC 60603-7

SOCKET TEL LT RJ11 6/4

- TEL LT screw
- screw contacts
- RJ11 6/4
- in accordance with IEC 60603-7

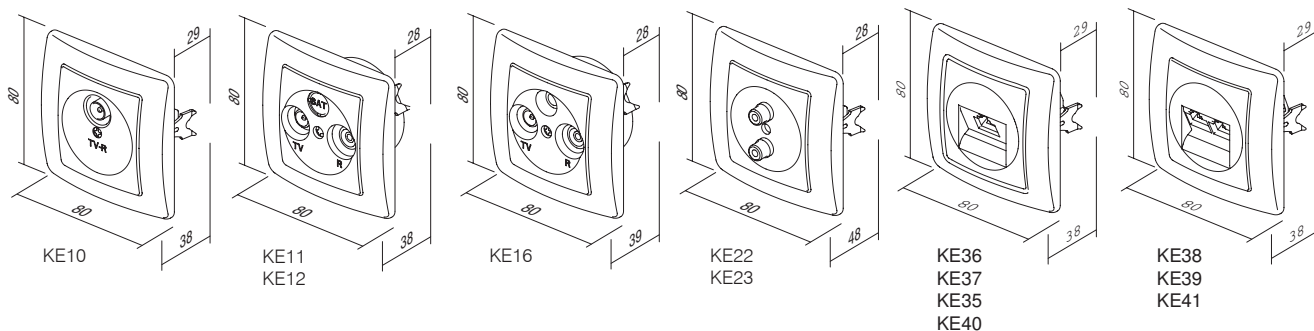

KRYTY PRE KOMUNIKÁČNÉ PRVKY KE

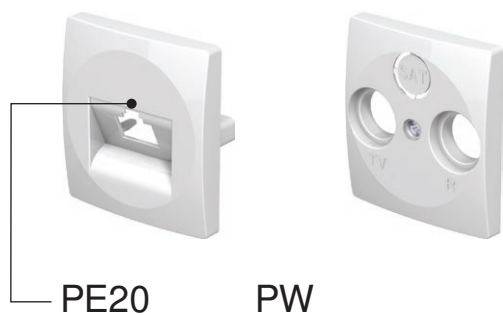

typ type	popis description	technické dáta technical data	farba colour
PE10	KRYT TV-R COVER TV-R	2P/3P	<input type="checkbox"/> PW polárna biela polar white
PE20	KRYT KS SAMOSTATNÝ COVER KS SINGLE		<input type="checkbox"/> IW slonová kosť ivory white
PE21	KRYT KS DVOJITÝ COVER KS DOUBLE		<input type="checkbox"/> ES strieborná matná elox silver
...	<input type="checkbox"/> CO biely duroplast white thermoset
			<input type="checkbox"/> NB čierna lesklá night black

KRYT TV-R 2P/3P



- PE10PW
- PE10IW
- PE10ES
- PE10CO
- PE10NB

- TV-R kryt, 2P alebo 3P so skrutkou

COVER TV-R 2P/3P

- TV-R cover, 2P or 3P with screw



KRYT KS SAMOSTATNÝ

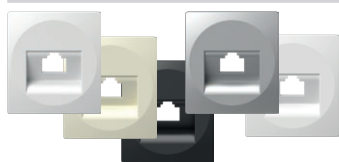

- PE20PW
- PE20IW
- PE20ES
- PE20CO
- PE20NB

- KS kryt samostatný

COVER KS SINGLE

- KS cover single



KRYT KS DVOJITÝ

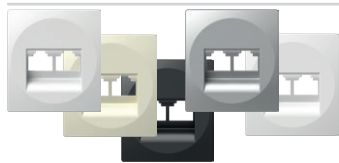

- PE21PW
- PE21IW
- PE21ES
- PE21NB

- KS kryt dvojitý

COVER KS DOUBLE

- KS cover double



KRYT TAE/TDO



- PE30PW
- PE30IW
- PE30ES
- PE30NB

- TAE alebo TDO kryt so skrutkou

COVER TAE/TDO

- TAE or TDO cover with screw

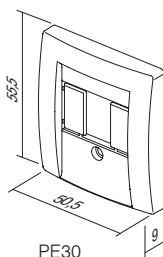

PE30

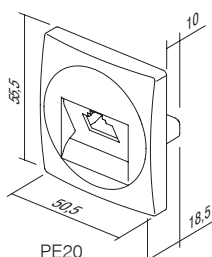

PE20

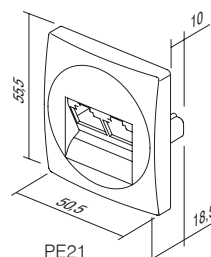

PE21

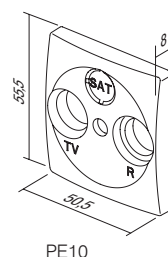

PE10



EE15

PW

typ type	popis description	technické dáta technical data	farba colour
EE15	STMIEVAČ ROTAČNÝ STRIEDAVÝ DIMMER ROTATIVE 2WAY	RL 400W	<input type="checkbox"/> PW polárna biela polar white
EE16	STMIEVAČ ROTAČNÝ STRIEDAVÝ DIMMER ROTATIVE 2WAY	RLC 400W	<input type="checkbox"/> IW slonová kosť ivory white
EE19	STMIEVAČ ROTAČNÝ STRIEDAVÝ DIMMER ROTATIVE 2WAY	LED 100W	<input type="checkbox"/> ES strieborná matná elox silver
⋮	⋮	⋮	<input type="checkbox"/> CO biely duroplast white thermoset
⋮	⋮	⋮	<input type="checkbox"/> NB čierna lesklá night black

STMIEVAČ ROTAČNÝ STRIEDAVÝ RL 400 W



EE15



- ovládanie rotácie so striedavým prepínačom
- zaťaženie RL, 40 W – 400 W
- kombinácia so striedavým prepínačom je možná
- kombinácia s viacerými stmievačmi nie je povolená
- v súlade s normami EN 60669-1 a STN EN 60669-2-1
- bezskrútkové upevnenie vodičov 1,5 mm²
- napájanie 230 V ~ 50 Hz
- vnútorný priemer tlačidla Ø 6 mm
- obsahuje náhradnú poistku

DIMMER ROTATIVE 2WAY RL 400W

- rotation control with 2-way switch
- load RL, 40W - 400W
- 2-way switch combination is possible
- more dimmers combination is not allowed
- in accordance with EN 60669-1 and EN 60669-2-1
- plug-in contacts 1.5mm²
- supply 230V~ 50Hz
- button inner diameter Ø6mm
- replaceable fuse included

STMIEVAČ ROTAČNÝ STRIEDAVÝ RLC 400 W



EE16



- ovládanie rotácie so striedavým prepínačom
- zaťaženie RLC, 20 W – 400 W
- kombinácia so striedavým prepínačom
- kombinácia s viacerými stmievačmi nie je povolená
- v súlade s normami EN 60669-1 a STN EN 60669-2-1
- bezskrútkové upevnenie vodičov 1,5 mm²
- vnútorný priemer tlačidla Ø 6 mm
- napájanie 230 V ~ 50 Hz
- elektronický istič

DIMMER ROTATIVE 2WAY RLC 400W

- rotation control with 2-way switch
- load RLC, 20W - 400W
- 2-way switch combination is possible
- more dimmers combination is not allowed
- in accordance with EN 60669-1 and EN 60669-2-1
- plug-in contacts 1.5mm²
- supply 230V~ 50Hz
- button inner diameter Ø6mm
- electronic fuse

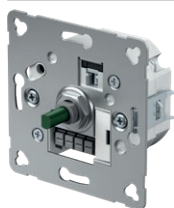

EE19

STMIEVAČ ROTAČNÝ STRIEDAVÝ LED 100 W

- ovládanie rotáciou so striedavým prepínačom
- zaťaženie: LED, 0 – 100 W (max. 10 LED žiaroviek)
GLS, 10 – 250 W
- kombinácia so striedavým prepínačom je možná
- kombinácia s viacerými stmievačmi nie je povolená
- v súlade s normami EN 60669-1 a STN EN 60669-2-1
- bezskrútkové upevnenie vodičov 1,5 mm²
- napájanie 230 V ~ 50 Hz
- obsahuje náhradnú poistku
- vnútorný priemer tlačidla Ø 6 mm

DIMMER ROTATIVE 2WAY LED 100W

- rotation control with 2-way switch
- load: LED, 0-100W (max. 10 LEDs)
GLS, 10-250W
- 2-way switch combination is possible
- more dimmers combination is not allowed
- in accordance with EN 60669-1 and EN 60669-2-1
- plug-in contacts 1.5mm²
- supply 230V~ 50Hz
- replaceable fuse included
- button inner diameter Ø6mm

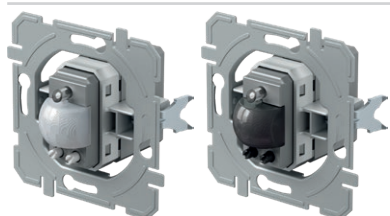

- EE32A1
- EE32A2



IR SPÍNAČ 5 A 250 V ~

- infračervený spínač
- napájacie napätie: 230 V ~ ±10 % 50 Hz
- relé: 5 A/250 V (prechod nulou)
- stupeň krytia: IP40
- prierez vodiča na kontaktnej svorke: 0,75 – 2,5 mm²
- uhol detekcie: až 110° pri 20 °C
- detekčná oblasť: pribl. 8 m pri 20 °C
- nastavitelnosť trvania: od pribl. 5 s až 12 min.
- nastavitelnosť jasů: od pribl. 5 do 200 lx
- prevádzková teplota: od 0 °C do + 40 °C
- nie je vhodný pre montáž do krabíc s hĺbkou 45 mm
- len pre použitie v interiéri

IR SWITCH 5A 230V~

- IR infrared switch
- supply voltage: 230V~ ±10 % 50Hz
- relay: 5A / 250V~ (zero crossing)
- protection rating: IP40
- cross-section of wires at the contact terminal: 0.75 - 2.5 mm²
- detection angle: up to 110° at 20°C
- detection area: approx. 8 m at 20°C
- adjustability of duration: from approx. 5 s to 12 min
- adjustability of brightness: from approx. 5 to 200 LUX
- operating temperature: from 0°C to +40°C
- not suitable for installation in 45 mm deep boxes
- only for indoor usage

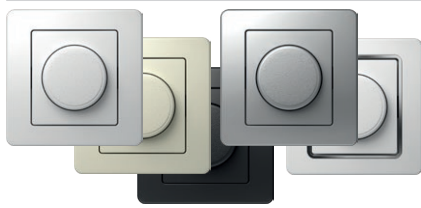

- EE15PW
- EE15IW
- EE15ES
- EE15CO
- EE15NB



STMIEVAČ ROTAČNÝ STRIEDAVÝ RL 400 W

- ovládanie rotáciou so striedavým prepínačom
- zaťaženie RL, 40 W – 400 W
- kombinácia so striedavým prepínačom je možná
- kombinácia s viacerými stmievačmi nie je povolená
- v súlade s normami EN 60669-1 a STN EN 60669-2-1
- bezskrútkové upevnenie vodičov 1,5 mm²
- napájanie 230 V ~ 50 Hz
- obsahuje náhradnú poistku

DIMMER ROTATIVE 2WAY RL 400W

- rotation control with 2-way switch
- load RL, 40W - 400W
- 2-way switch combination is possible
- more dimmers combination is not allowed
- in accordance with EN 60669-1 and EN 60669-2-1
- plug-in contacts 1.5mm²
- supply 230V~ 50Hz
- replaceable fuse included

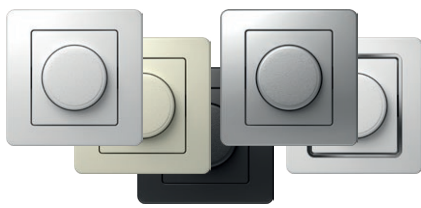

- EE16PW
- EE16IW
- EE16ES
- EE16CO
- EE16NB



STMIEVAČ ROTAČNÝ STRIEDAVÝ RLC 400 W

- ovládanie rotácie so striedavým prepínačom
- zaťaženie RLC, 20 W – 400 W
- kombinácia so striedavým prepínačom je možná
- kombinácia s viacerými stmievačmi nie je povolená
- v súlade s normami EN 60669-1 a STN EN 60669-2-1
- bezskrútkové upevnenie vodičov 1,5 mm²
- napájanie 230 V ~ 50 Hz
- obsahuje náhradnú poistku

DIMMER ROTATIVE 2WAY RLC 400W

- rotation control with 2-way switch
- load RLC, 20W - 400W
- 2-way switch combination is possible
- more dimmers combination is not allowed
- in accordance with EN 60669-1 and EN 60669-2-1
- plug-in contacts 1.5mm²
- supply 230V~ 50Hz
- electronic fuse



- EE19PW
- EE19IW
- EE19ES
- EE19CO
- EE19NB



STMIEVAČ ROTAČNÝ STRIEDAVÝ LED 100 W

- ovládanie rotáciou so striedavým prepínačom
- zaťaženie: LED, 0 – 100 W (max. 10 LED žiaroviek)
GLS, 10 – 250 W
- kombinácia so striedavým prepínačom je možná
- kombinácia s viacerými stmievačmi nie je povolená
- v súlade s normami EN 60669-1 a STN EN 60669-2-1
- bezskrútkové upevnenie vodičov 1,5 mm²
- napájanie 230 V ~ 50 Hz
- obsahuje náhradnú poistku

DIMMER ROTATIVE 2WAY LED 100W

- rotation control with 2-way switch
- load: LED, 0-100W (max. 10 LEDs)
GLS, 10-250W
- 2-way switch combination is possible
- more dimmers combination is not allowed
- in accordance with EN 60669-1 and EN 60669-2-1
- plug-in contacts 1.5mm²
- supply 230V~ 50Hz
- replaceable fuse included



- EE32PW
- EE32IW
- EE32ES
- EE32CO
- EE32NB



IR SPÍNAČ 5 A 250 V ~

- infračervený spínač
- napájacie napätie: 230 V ~ ±10 % 50 Hz
- relé: 5 A/250 V (prechod nulou)
- stupeň krytia: IP40
- prierez vodiča na kontaktnej svorke: 0,75 – 2,5 mm²
- uhol detekcie: až 110° pri 20 °C
- detekčná oblasť: pribl. 8 m pri 20 °C
- nastavitelnosť trvania: od pribl. 5 s až 12 min.
- nastavitelnosť jasů: od pribl. 5 do 200 lx
- prevádzková teplota: od 0 °C do +40 °C
- nie je vhodný pre montáž do krabíc s hĺbkou 45 mm
- len pre použitie v interiéri

IR SWITCH 5A 230V~

- IR infrared switch
- supply voltage: 230V~ ±10 % 50Hz
- relay: 5A / 250V~ (zero crossing)
- protection rating: IP40
- cross-section of wires at the contact terminal: 0.75 - 2.5 mm²
- detection angle: up to 110° at 20°C
- detection area: approx. 8 m at 20°C
- adjustability of duration: from approx. 5 s to 12 min
- adjustability of brightness: from approx. 5 to 200 LUX
- operating temperature: from 0°C to +40°C
- not suitable for installation in 45 mm deep boxes
- only for indoor usage





- EE69PW
- EE69IW
- EE69NB
- EE69ES

NABÍJAČKA USB PD 20 W

- USB napájací zdroj s napájaním do 20 W.
 - na nabíjanie elektronických zariadení cez štandardný USB port (kompatibilné aj so zariadeniami Apple)
 - napájanie: 100 – 230 V~ 50/60 Hz
 - spotreba počas prevádzky: 420 mA pri 100 V~/220 mA pri 230 V~
 - spotreba v pohotovostnom režime: < 100 mW pri 230 V~
 - výstupné napätie: 20 W Max
 - Výstup:
 - USB typ C: 5,0 VDC 3,0 A; 9,0 VDC 2,2 A; 12,0 VDC 1,67 A (PD 20 W)
 - USB typ A: 5,0 VDC 3,0 A; 9,0 VDC 2,0 A; 12,0 VDC 1,5 A (QC 18 W)
 - USB A + C: 5 VDC 3 A
 - typ konektora: 1× USB A; 1× USB C
 - priemerná účinnosť v aktívnom stave: 86 %
 - účinnosť pri minimálnom zatažení (10 %): 81 %
 - prevádzková teplota: 0 °C/+ 45 °C (použitie v interiéri)
 - trieda ochrany IP: - IP20, na použitie len v interiéri
 - zariadenie bezpečnostnej triedy II
 - prepäťová ochrana (EN 60364-4-44): trieda III
 - skrutkové upevnenie vodičov max. 2,5 mm²
 - zariadenie s posunom kontaktov min. 3 mm
 - nie je vhodný na montáž do krabíc s hĺbkou 45 mm a krabice CUBO IP20
- Vyhovuje:
 Smerniciam: BT, EMC, RoHS, ErP
 Standardom: EN IEC 62368-1, EN 55032, EN55035, EN IEC 61000-3-2, EN 61000-3-3, EN 50563, EN IEC 63000
 Ďalším predpisom: (EU) n. 2019/1782 REACh, n. 1907/2006 – art.33.
 Výrobok môže obsahovať stopy olova.



USB POWER SUPPLY UNIT PD 20W

- 20 W USB power delivery power supply unit
 - for charging of electronic devices via a standard USB port (also compatible with Apple devices)
 - power supply: 100-230V~ 50/60Hz
 - power consumption: 420mA at 100V~/220mA at 230V~
 - standby power consumption: <100mW at 230V~
 - Output power: 20 W Max
 - Output:
 - USB tip C: 5.0 VDC 3.0A; 9.0 VDC 2.2 A; 12.0 VDC 1.67 A (PD 20W)
 - USB tip A: 5.0 VDC 3.0A; 9.0 VDC 2.0 A; 12.0 VDC 1.5 A (QC 18W)
 - USB A+C: 5 VDC 3A
 - connector type: 1x USB A; 1x USB C
 - average efficiency in active mode: 86%
 - efficiency with low load (10%): 81%
 - operating temperature: 0°C/+45°C (indoor use)
 - IP protection class: IP20, indoor use only
 - class device II
 - overvoltage category (EN 60364-4-44): Class III
 - screw contacts: max. 2.5 mm²
 - device with a contact gap of at least 3mm
- Conformity:
 Directive: BT, EMC, RoHS, ErP
 Standards: EN IEC 62368-1, EN 55032, EN55035, EN IEC 61000-3-2, EN 61000-3-3, EN 50563, EN IEC 63000
 External power supplies regulation: (EU) n. 2019/1782 REACh, n. 1907/2006 – art.33. The product may contain traces of lead.

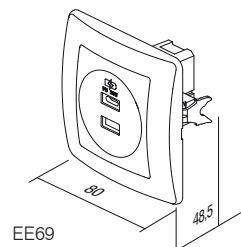

EE69

EE15, EE16, EE19

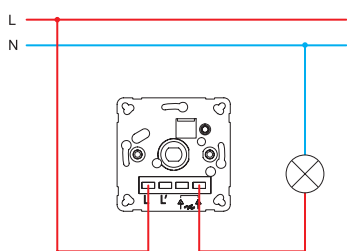

EE15, EE16, EE19

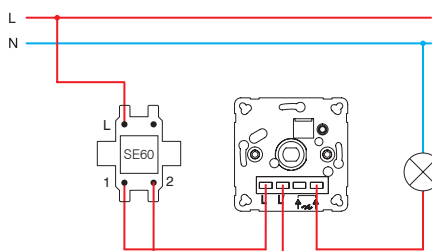

EE15, EE16, EE19

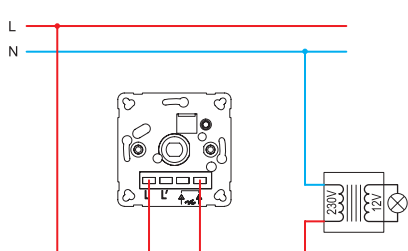

EE15, EE16, EE19

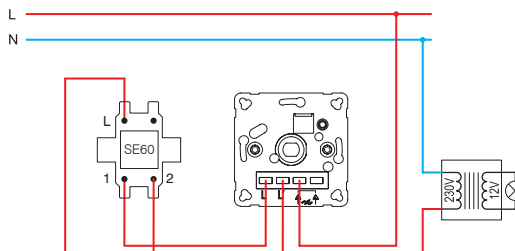

EE16, EE19

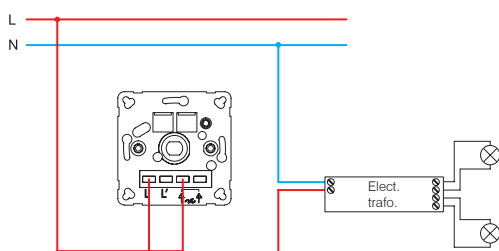

EE16, EE19

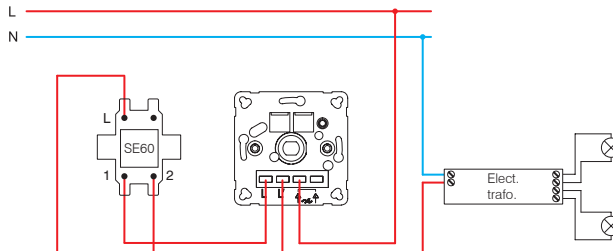

EE15 (40÷400W)

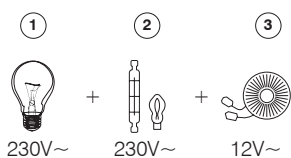

EE16 (20÷400W)

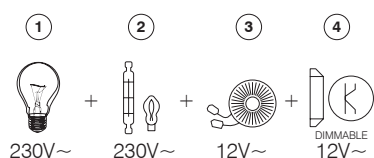

EE19 (GLS 10÷250W ; LED 0÷100W)

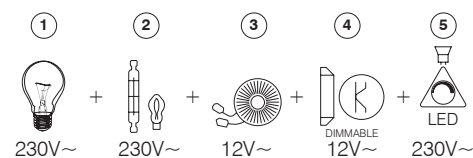

- 1 – žiarovka / incandescent lamp
- 2 – halogénová žiarovka / halogen lamp

- 3 – klasický transformátor / classical transformer
- 4 – stmievateľný elektronický transformátor / dimmable electronic transformer

- 5 – stmievateľná LED žiarovka / dimmable LED lamp

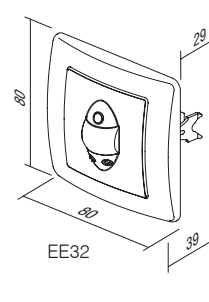
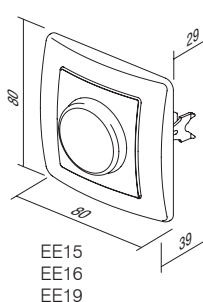
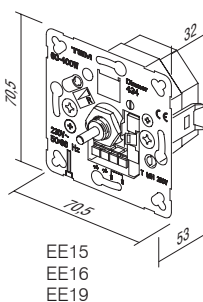

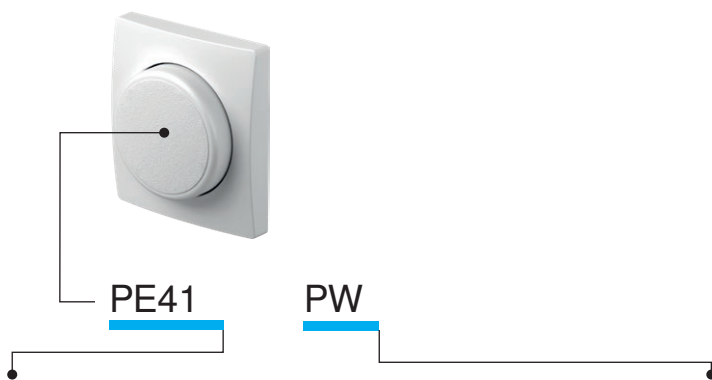

typ type	popis description	farba colour
PE41	KRYT NA STMIEVAČ COVER DIMMER	<input type="checkbox"/> PW polárna biela <i>polar white</i> <input type="checkbox"/> IW slonová kosť <i>ivory white</i> <input type="checkbox"/> ES strieborná matná <i>elox silver</i> <input type="checkbox"/> CO biely duroplast <i>white thermoset</i> <input type="checkbox"/> NB čierna lesklá <i>night black</i>



- PE41PW
- PE41IW
- PE41NB
- PE41ES
- PE41CO

KRYT NA STMIEVAČ Ø 6

- kryt na stmievač Ø 6 mm
- pre EE15, EE16, EE19

COVER DIMMER Ø6
- cover dimmer Ø6mm
- for EE15, EE16, EE19



- PE32PW
- PE32IW
- PE32NB
- PE32ES

KRYT IR SPÍNAČ

- kryt IR spínač

COVER IR SWITCH
- cover IR switch

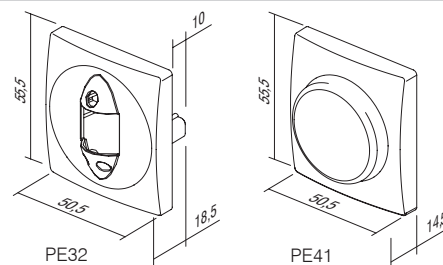

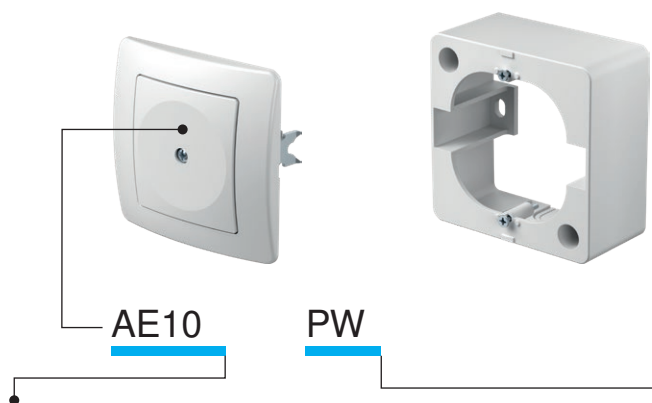

typ type	popis description	farba colour
AE10	VÝPLŇ BLANK	<input type="checkbox"/> PW polárna biela polar white
AE20	SPOJOVACIA SKRINKA 3P+N+E 5 x 4 mm ² CONNECTION BOX 3P+N+E 5x4mm ²	<input type="checkbox"/> IW slonová kosť ivory white
AE30	KRABICA PRE POVRCHOVÚ MONTÁŽ SURFACE MOUNT BOX	<input type="checkbox"/> ES strieborná matná elox silver
⋮	⋮	<input type="checkbox"/> CO biely duroplast white thermoset
⋮	⋮	<input type="checkbox"/> NB čierna lesklá night black

VÝPLŇ



- AE10PW
- AE10IW
- AE10NB
- AE10ES
- AE10CO

- na vyplnenie prázdnych miest

BLANK

- for filling up empty spaces

SPOJOVACIA KRABICA PÄŤPÓLOVÁ 3P+N+E 5 x 4 mm²

- AE20PW
- AE20IW

- 3P+N+E prípojka
- 16 A 400 V ~
- v súlade s normou VDE 0606-1:2000
- skrutkové upevnenie vodičov 1,5 až 4 mm²

CONNECTION BOX 5POLE 3P+N+E 5x4mm²

- 3P+N+E connection box
- 16A 400V~
- in accordance with VDE 0606-1:2000
- screw contacts 1.5-4mm²



KRABICA PRE POVRCHOVÚ MONTÁŽ 1

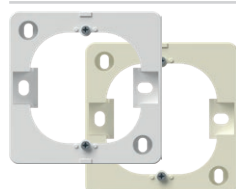

- AE30PW
- AE30IW

- krabica na povrchovú montáž

SURFACE MOUNT BOX 1

- surface mounting box



POVRCHOVÁ KRABICA PRE DVOJITÚ ZÁSUVKU

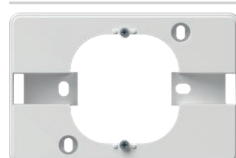

- AE31PW

- krabica na povrchovú montáž

SURFACE MOUNT BOX FOR DOUBLE SOCKET

- surface mounting box



CHRÁNIČ STENY



- AE50PW
- AE50TS

- chránič steny okolo vypínača alebo zásuvky

WALL PROTECTION

- protects surface around socket or switch

DETSKÁ OCHRANA KS



- AE51PW
- AE51IW

- KS detská ochrana pred dotykom s kontaktmi pod napätím

CHILD PROTECTION KS

- KS additional child protection insert - shuttered live contacts

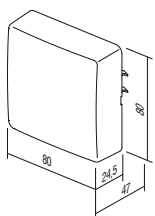

AE20

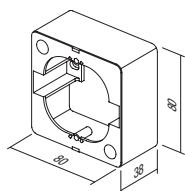

AE30

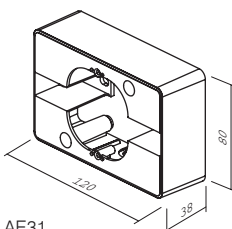

AE31

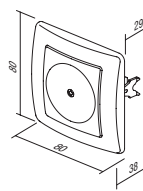

AE10

S U R R O U N D S O E

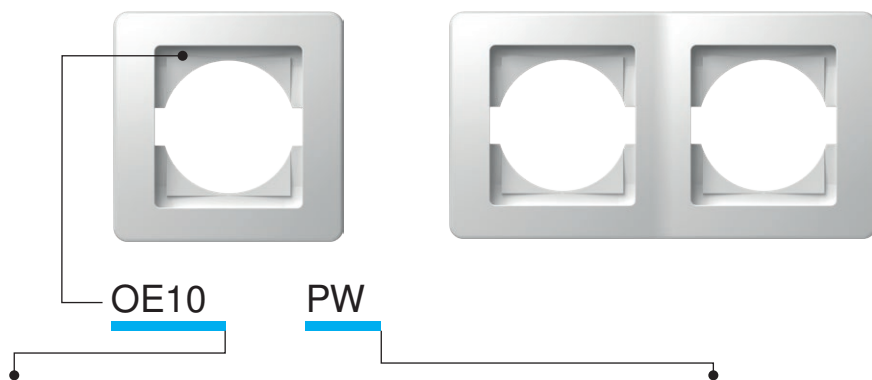

typ type	popis description	farba colour
OE10	RÁMIK EKONOMIK 1 SURROUND EKONOMIK 1	<input type="checkbox"/> PW polárna biela polar white
OE20	RÁMIK EKONOMIK 2 HORIZONTÁLNY SURROUND EKONOMIK 2 HORIZONTAL	<input type="checkbox"/> IW slonová kosť ivory white
OE30	RÁMIK EKONOMIK 3 HORIZONTÁLNY SURROUND EKONOMIK 3 HORIZONTAL	<input type="checkbox"/> ES strieborná matná elox silver
⋮	⋮	<input type="checkbox"/> CO biely duroplast white thermoset
⋮	⋮	<input type="checkbox"/> NB čierna lesklá night black

RÁMIK EKONOMIK 1



- OE10PW
- OE10IW
- OE10ES
- OE10CO
- OE10NB

- dekoratívny samostatný rámik
- v súlade s normou EN 60669-1

SURROUND EKONOMIK 1
- decorative surround 1-gang
- in accordance with EN 60669-1

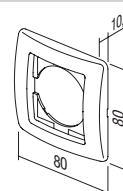

RÁMIK EKONOMIK 2 HORIZONTÁLNY



- OE20PW
- OE20IW
- OE20ES
- OE20CO
- OE20NB

- dekoratívny 2-rámik horizontálny
- v súlade s normou EN 60669-1

SURROUND EKONOMIK 2 HORIZONTAL
- decorative surround 2-gang horizontal
- in accordance with EN 60669-1

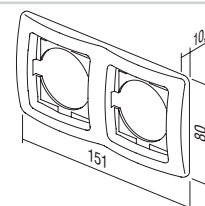

RÁMIK EKONOMIK 2 VERTIKÁLNY



- OE21PW
- OE21IW
- OE21ES
- OE21CO
- OE21NB

- dekoratívny 2-rámik vertikálny
- v súlade s normou EN 60669-1

SURROUND EKONOMIK 2 VERTICAL
- decorative surround 2-gang vertical
- in accordance with EN 60669-1

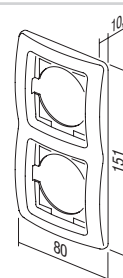

RÁMIK EKONOMIK 3 HORIZONTÁLNY



- OE30PW
- OE30IW
- OE30ES
- OE30CO
- OE30NB

- dekoratívny 3-rámik horizontálny
- v súlade s normou EN 60669-1

SURROUND EKONOMIK 3 HORIZONTAL
- decorative surround 3-gang horizontal
- in accordance with EN 60669-1

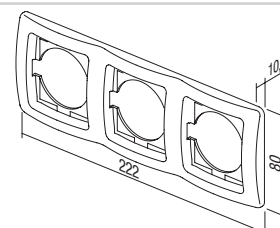

RÁMIK EKONOMIK 3 VERTIKÁLNY



- OE31PW
- OE31IW
- OE31ES
- OE31CO
- OE31NB

- dekoratívny 3-rámik vertikálny
- v súlade s normou EN 60669-1

SURROUND EKONOMIK 3 VERTICAL
- decorative surround 3-gang vertical
- in accordance with EN 60669-1

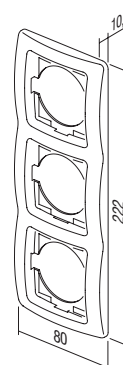

RÁMIK EKONOMIK 4 HORIZONTÁLNY



- OE40PW
- OE40IW
- OE40ES
- OE40NB

- dekoratívny 4-rámik horizontálny
- v súlade s normou EN 60669-1

SURROUND EKONOMIK 4 HORIZONTAL
- decorative surround 4-gang horizontal
- in accordance with EN 60669-1

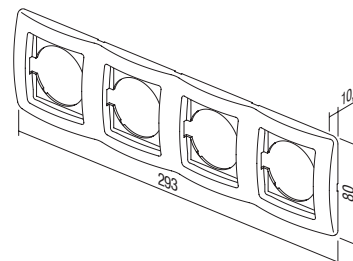

RÁMIK EKONOMIK 4 VERTIKÁLNY



- OE41PW
- OE41IW
- OE41ES
- OE41NB

- dekoratívny 4-rámik vertikálny
- v súlade s normou EN 60669-1

SURROUND EKONOMIK 4 VERTICAL
- decorative surround 4-gang vertical
- in accordance with EN 60669-1

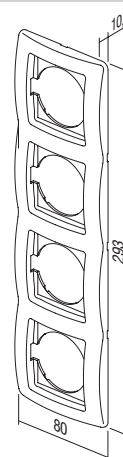

RÁMIK EKONOMIK 5 HORIZONTÁLNY



- OE50PW
- OE50IW
- OE50ES
- OE50NB

- dekoratívny 5-rámik horizontálny
- v súlade s normou EN 60669-1

SURROUND EKONOMIK 5 HORIZONTAL
- decorative surround 5-gang horizontal
- in accordance with EN 60669-1

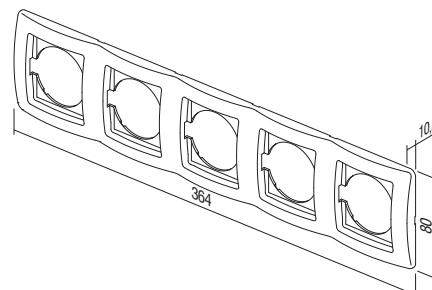

DEKORATÍVNE RÁMIKY COLOUR /
 COLOR DECORATIVE FRAMES



OE90GR ZELENÁ /
 GREEN

OE90BL MODRÁ /
 BLUE

OE90VO FIALOVÁ /
 VIOLET

OE90PI RUŽOVÁ /
 PINK

OE90RD ČERVENÁ /
 RED

OE90YL ŽLTÁ /
 YELLOW

OE90WH BIELA /
 WHITE

OE90GY SIVÁ /
 GREY

OE90BK ČIERNA /
 BLACK

OE90MB METALICKÁ MODRÁ /
 MET. BLUE

OE90BZ BRONZOVÁ /
 BRONZE

OE90CR STRIEBORNÁ /
 SILVER

OE90GO ZLATÁ /
 GOLD





fontana



TEM



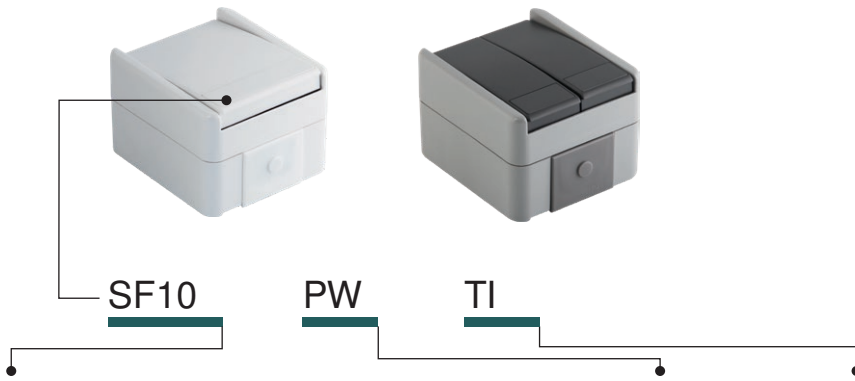

typ type	popis description	technické dáta technical data	farba colour	voliteľné údaje 1 optional data 1
SF10	SPÍNAČ JEDNOPÓLOVÝ SWITCH 1WAY	IP44 10AX 250V~	<input type="checkbox"/> PW biela – matná white-mat	TI tlejkva + indikátor neon lamp+indication
SF11	TLAČIDLO JEDNOPÓLOVÉ PUSH BUTTON 1WAY	IP44 10A 250V~	<input type="checkbox"/> GY sivá – matná grey-mat	
SF20	SPÍNAČ DVOJPÓLOVÝ SWITCH 2POLE	IP44 10AX 250V~		
:	:	:		
:	:	:		

SPÍNAČ JEDNOPÓLOVÝ IP44 10 AX 250 V ~



- SF10PW
- SF10GY

- 10 AX 250 V ~, typ SF10
 - v súlade s normou EN 60669-1
 - bezskrutkové upevnenie vodičov 1,5 – 2,5 mm²
 SWITCH 1WAY IP44 10AX 250V~
 - 10AX 250V~, type SF10
 - in accordance with EN 60669-1
 - plug-in contacts 1.5-2.5mm²



SPÍNAČ JEDNOPÓLOVÝ IP44 10 AX 250 V ~ __ TI



- SF10PWTI
- SF10GYTI

- TI indikátor + tlejkva
 - 10 AX 250 V ~, typ SF10
 - v súlade s normou EN 60669-1
 - bezskrutkové upevnenie vodičov 1,5 – 2,5 mm²
 SWITCH 1WAY IP44 10AX 250V~ __ TI
 - TI indicator+neon lamp
 - 10AX 250V~, type SF10
 - in accordance with EN 60669-1
 - plug-in contacts 1.5-2.5mm²



TLAČIDLO JEDNOPÓLOVÉ IP44 10 A 250 V ~ __ TI



- SF11PWTI
- SF11GYTI

- TI indikátor + tlejkva
 - 10 A 250 V ~, typ SF11
 - v súlade s normou EN 60669-1
 - bezskrutkové upevnenie vodičov 1,5 – 2,5 mm²
 PUSH BUTTON 1WAY IP44 10A 250V~ __ TI
 - TI indicator+neon lamp
 - 10A 250V~, type SF11
 - in accordance with EN 60669-1
 - plug-in contacts 1.5-2.5mm²















SPÍNAČ DVOJPÓLOVÝ IP44 10 AX 250 V ~



- SF20PW
- SF20GY

- 10 AX 250 V ~, typ SF20
 - v súlade s normou EN 60669-1
 - bezskrutkové upevnenie vodičov 1,5 – 2,5 mm²
 SWITCH 2POLE IP44 10AX 250V~
 - 10AX 250V~, type SF20
 - in accordance with EN 60669-1
 - plug-in contacts 1.5-2.5mm²



	<ul style="list-style-type: none"> <input type="checkbox"/> SF50PW <input checked="" type="checkbox"/> SF50GY 	<p>SPÍNAČ SÉRIOVÝ IP44 10 AX 250 V ~</p> <ul style="list-style-type: none"> - 10 AX 250 V ~, typ SF50 - v súlade s normou EN 60669-1 - bezskrutkové upevnenie vodičov 1,5 – 2,5 mm² 	
	<ul style="list-style-type: none"> <input type="checkbox"/> SF51PW <input checked="" type="checkbox"/> SF51GY 	<p>TLAČIDLO SÉRIOVÉ IP44 10 A 250 V ~</p> <ul style="list-style-type: none"> - 10 A 250 V ~, typ SF51 - v súlade s normou EN 60669-1 - bezskrutkové upevnenie vodičov 1,5 – 2,5 mm² 	
	<ul style="list-style-type: none"> <input type="checkbox"/> SF60PW <input checked="" type="checkbox"/> SF60GY 	<p>STRIEDAVÝ PREPÍNAČ IP44 10 AX 250 V ~</p> <ul style="list-style-type: none"> - 10 AX 250 V ~, typ SF60 - v súlade s normou EN 60669-1 - bezskrutkové upevnenie vodičov 1,5 – 2,5 mm² 	
	<ul style="list-style-type: none"> <input type="checkbox"/> SF60PWTI <input checked="" type="checkbox"/> SF60GYTI 	<p>STRIEDAVÝ PREPÍNAČ IP44 10 AX 250 V ~ _ TI</p> <ul style="list-style-type: none"> - TI indikátor + neónová lampka - 10 AX 250 V ~, typ SF60 - v súlade s normou EN 60669-1 - bezskrutkové upevnenie vodičov 1,5 – 2,5 mm² 	
	<ul style="list-style-type: none"> <input type="checkbox"/> SF63PW <input checked="" type="checkbox"/> SF63GY 	<p>STRIEDAVÝ PREPÍNAČ DVOJITÝ IP44 10 AX 250 V ~</p> <ul style="list-style-type: none"> - 10 AX 250 V ~, typ SF63 - v súlade s normou EN 60669-1 - bezskrutkové upevnenie vodičov 1,5 – 2,5 mm² 	
	<ul style="list-style-type: none"> <input type="checkbox"/> SF70PW <input checked="" type="checkbox"/> SF70GY 	<p>KRÍŽOVÝ PREPÍNAČ IP44 10 AX 250 V ~</p> <ul style="list-style-type: none"> - 10 AX 250 V ~, typ SF70 - v súlade s normou EN 60669-1 - bezskrutkové upevnenie vodičov 1,5 – 2,5 mm² 	

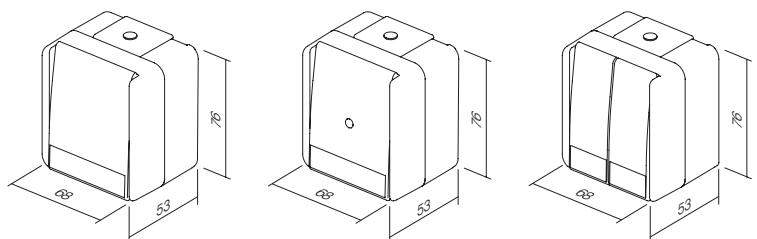



VF10

PW

typ type	popis description	technické dáta technical data	farba colour
VF10	ZÁSUVKA SCHUKO + KRYT SOCKET SCHUKO+COVER	IP44 2P+E 16A 250V~	<input type="checkbox"/> PW biela – matná white-mat <input type="checkbox"/> GY sivá – matná grey-mat

ZÁSUVKA SCHUKO + KRYT IP44 2P+E 16 A 250 V ~



- VF10PW
- VF10GY

- skrutkové upevnenie vodičov 1,5 – 2,5 mm²
- 2P + E schuko + kryt
- 16 A 250 V ~, typ VF10
- v súlade s normami EN 60884-1, CEE7

SOCKET SCHUKO+COVER IP44 2P+E 16A 250V~

- screw contacts 1.5-2.5mm²
- 2P+E schuko+cover
- 16A 250V~, type VF10
- in accordance with EN 60884-1, CEE7



ZÁSUVKA SCHUKO + KRYT IP44 2P+E 16 A 250 V ~ BV



- VF12PW
- VF12GY

- BV bezskrutkové upevnenie vodičov 1,5 – 2,5 mm²
- 2P + E schuko + kryt
- 16 A 250 V ~, typ VF12
- v súlade s normami EN 60884-1, CEE7

SOCKET SCHUKO+COVER IP44 2P+E 16A 250V~ BV

- BV plug-in contacts 1.5-2.5mm²
- 2P+E schuko+cover
- 16A 250V~, type VF12
- in accordance with EN 60884-1, CEE7

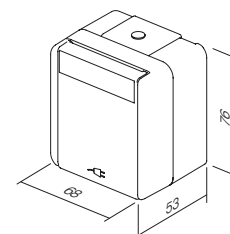

VF10
VF12

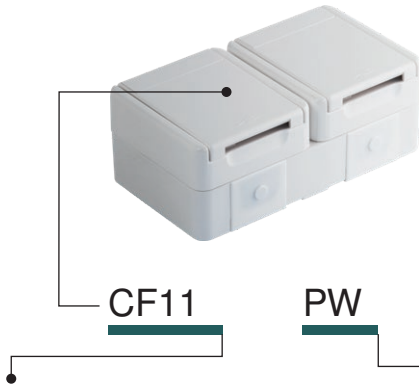

typ type	popis description	technické dáta technical data	farba colour
CF10	SÚPRAVA ZÁSUVIEK SCHUKO DVOJITÁ HORIZONT. SOCKET SET SCHUKO DOUBLE HORIZ	2x 2P+E 16A 250V~ IP44	<input type="checkbox"/> PW biela – matná white-mat
CF11	SÚPRAVA ZÁSUVIEK SCHUKO DVOJITÁ VERTIK. SOCKET SET SCHUKO DOUBLE VERT	2x 2P+E 16A 250V~ IP44	<input checked="" type="checkbox"/> GY sivá – matná grey-mat
CF12	ZÁSUVKA SCH + DVOJPÓLOVÝ VYPÍNAČ HORIZONT. SOCKET SCH+SWITCH 2WAY HORIZ	16A + 10A 250V~ IP44	
⋮	⋮	⋮	
⋮	⋮	⋮	

SÚPRAVA ZÁSUVIEK SCHUKO DVOJITÁ HORIZONTÁLNA IP44 2 x 2P+E 16 A 250 V ~



- CF10PW
 CF10GY

- skrutkové upevnenie vodičov 1,5 – 2,5 mm²
- 2 x 2P+E schuko + kryt horizontálny
- 16 A 250 V ~, typ CF10
- v súlade s normami EN 60884-1, CEE7

SOCKET SET SCHUKO DOUBLE
HORIZONTAL IP44 2x 2P+E 16A 250V~
- screw contacts 1.5-2.5mm²
- 2x 2P+E schuko+cover horizontal
- 16A 250V~, type CF10
- in accordance with EN 60884-1, CEE7



SÚPRAVA ZÁSUVIEK SCHUKO DVOJITÁ VERTIKÁLNA IP44 2 x 2P+E 16 A 250 V ~



- CF11PW
 CF11GY

- skrutkové upevnenie vodičov 1,5 – 2,5 mm²
- 2 x 2P+E schuko + kryt vertikálny
- 16 A 250 V ~, typ CF11
- v súlade s normami EN 60884-1, CEE7

SOCKET SET SCHUKO DOUBLE VERTICAL
IP44 2x 2P+E 16A 250V~
- screw contacts 1.5-2.5mm²
- 2x 2P+E schuko+cover vertical
- 16A 250V~, type CF11
- in accordance with EN 60884-1, CEE7



ZÁSUVKA SCH + DVOJPÓLOVÝ SPÍNAČ HORIZONTÁLNY IP44 16 A + 10 AX 250 V ~



- CF12PW
 CF12GY

- skrutkové (zásuvka), bezskrutkové (spínač) upevnenie 1,5 – 2,5 mm²
- 2P+E schuko + kryt + spínač dvojsmerný horizontálny
- 16 A + 10 AX 250 V ~, typ CF12
- v súlade s normami EN 60884-1, CEE7, EN 60669-1

SOCKET SCH+SWITCH SET 2WAY
HORIZONTAL IP44 16A + 10AX 250V~
- screw (socket), plug-in (switch) contacts 1.5-2.5mm²
- 2P+E schuko+cover + switch 2-way horizontal
- 16A + 10AX 250V~, type CF12
- in accordance with EN 60884-1, CEE7, EN 60669-1



ZÁSUVKA SCH + SÚPRAVA DVOJPÓLOVÝCH SPÍNAČOV VERTIKÁLNA IP44 16A + 10 AX 250 V ~



- CF13PW
- CF13GY

- skrutkové (zásuvka), bezskrutkové (spínač) upevnenie 1,5 – 2,5 mm²
- 2P+E schuko + kryt + spínač dvojsmerný vertikálny
- 16 A + 10 AX 250 V ~, typ CF13
- v súlade s normami EN 60884-1, CEE7, EN 60669-1

SOCKET SCH+SWITCH 2WAY SET VERTICAL IP44 16A + 10AX 250V~

- screw (socket), plug-in (switch) contacts 1.5-2.5mm²
- 2P+E schuko+cover + switch 2-way vertical
- 16A + 10AX 250V~, type CF13
- in accordance with EN 60884-1, CEE7, EN 60669-1



SÚPRAVA ZÁSUVIEK SCHUKO DVOJITÁ HORIZONTÁLNA IP44 2x 2P+E 16 A 250 V ~ BV



- CF14PW
- CF14GY

- BV bezskrutkové upevnenie vodičov 1,5 – 2,5 mm²
- 2 x 2P+E schuko + kryt horizontálny
- 16 A 250 V ~, typ CF14
- v súlade s normami EN 60884-1, CEE7

SOCKET SET SCHUKO DOUBLE HORIZONTAL IP44 2x 2P+E 16A 250V~ BV

- BV plug-in contacts 1.5-2.5mm²
- 2x 2P+E schuko+cover horizontal
- 16A 250V~, type CF14
- in accordance with EN 60884-1, CEE7



SÚPRAVA ZÁSUVIEK SCHUKO DVOJITÁ VERTIKÁLNA IP44 2x 2P+E 16 A 250 V ~ BV



- CF15PW
- CF15GY

- BV bezskrutkové upevnenie vodičov 1,5 – 2,5 mm²
- 2 x 2P+E schuko + kryt vertikálny
- 16 A 250 V ~, typ CF15
- v súlade s normami EN 60884-1, CEE7

SOCKET SET SCHUKO DOUBLE VERTICAL IP44 2x 2P+E 16A 250V~ BV

- BV plug-in contacts 1.5-2.5mm²
- 2x 2P+E schuko+cover vertical
- 16A 250V~, type CF15
- in accordance with EN 60884-1, CEE7



ZÁSUVKA + SÚPRAVA SPÍNAČOV + DVOJPÓLOVÉ HORIZONTÁLNE IP44 16A + 10 AX 250 V ~ BV



- CF16PW
- CF16GY

- BV bezskrutkové upevnenie vodičov 1,5 – 2,5 mm²
- 2P+E schuko + kryt + spínač dvojsmerný horizontálny
- 16 A + 10 AX 250 V ~, typ CF16
- v súlade s normami EN 60884-1, CEE7, EN 60669-1

SOCKET+SWITCH SET SCH+2WAY HORIZONTAL IP44 16A + 10AX 250V~ BV

- BV plug-in contacts 1.5-2.5mm²
- 2P+E schuko+cover + switch 2-way horizontal
- 16A + 10AX 250V~, type CF16
- in accordance with EN 60884-1, CEE7, EN 60669-1



ZÁSUVKA + SÚPRAVA SPÍNAČOV + DVOJPÓLOVÉ VERTIKÁLNE IP44 16A + 10 AX 250 V ~ BV



- CF17PW
- CF17GY

- BV bezskrutkové upevnenie vodičov 1,5 – 2,5 mm²
- 2P+E schuko + kryt + vypínač dvojsmerný vertikálny
- 16 A + 10 AX 250 V ~, typ CF17
- v súlade s normami EN 60884-1, CEE7, EN 60669-1

SOCKET SCH+SWITCH 2WAY SET VERTICAL IP44 16A + 10AX 250V~ BV

- BV plug-in contacts 1.5-2.5mm²
- 2P+E schuko+cover + switch 2-way vertical
- 16A + 10AX 250V~, type CF17
- in accordance with EN 60884-1, CEE7, EN 60669-1



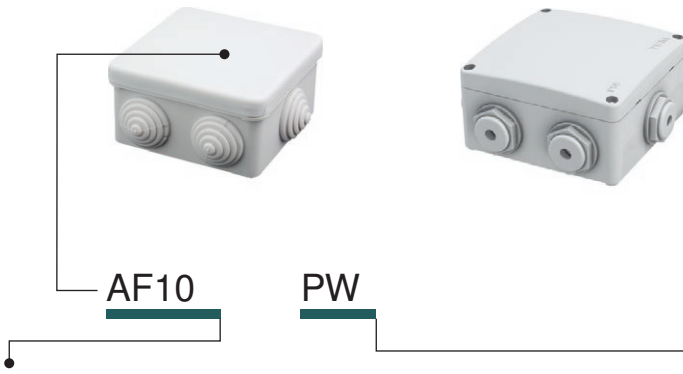

typ type	popis description	technické dáta technical data	farba colour
AF10	ROZVODNÁ KRABICA DISTRIBUTION BOX	IP44 RN01	<input type="checkbox"/> PW biela – matná white-mat
AF20	ROZVODNÁ KRABICA DISTRIBUTION BOX	IP55 ND01	<input type="checkbox"/> GY sivá – matná grey-mat

ROZVODNÁ KRABICA IP44 RN01



- AF10PW
- AF10GY

- rozvodná krabica s montážou na povrchu IP44
- 16 A 400 V ~
- v súlade s normou IEC/EN 60670-1, IEC/EN 60670-22

DISTRIBUTION BOX IP44 RN01

- surface mounting distribution box IP44
- 16A 400V~
- in accordance with IEC/EN 60670-1, IEC/EN 60670-22

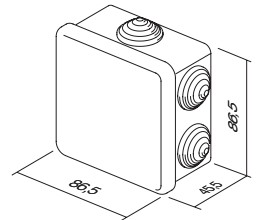

ROZVODNÁ KRABICA IP55 ND01



- AF20PW
- AF20GY

- spojovacia krabica s montážou na povrchu IP55
- priechodky priložené
- v súlade s normou IEC/EN 60670-1, IEC/EN 60670-22

DISTRIBUTION BOX IP55 ND01

- surface mounting connection box IP55
- glands included
- in accordance with IEC/EN 60670-1, IEC/EN 60670-22

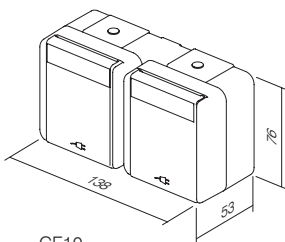
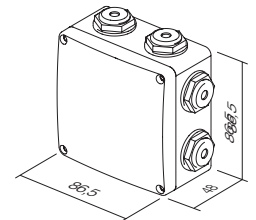

CF10
CF14

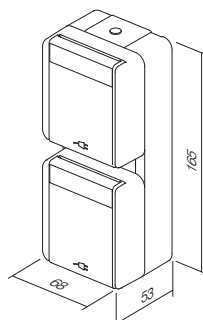

CF11
CF15

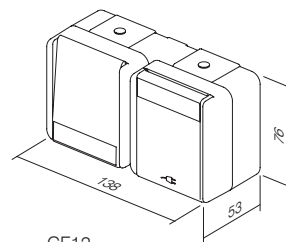

CF12
CF16

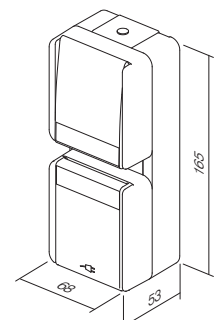

CF13
CF17

kód	popis výrobku	strana	kód	popis výrobku	strana
SPÍNAČE SM			KOMUNIKÁCIE KM		
SM10	SPÍNAČ JEDNOPÓLOVÝ 16 AX 250 V- 1M	44	KM10--	ZÁSUVKA TV ZÁKLADNÁ 0 dB 1M	60
SM11	TLAČIDLO JEDNOPÓLOVÉ 16 A 250 V- 1M	44	KM20--	ZÁSUVKA TV ZÁKLADNÁ 0 dB 2M	60
SM12	SPÍNAČ JEDNOPÓLOVÝ 20 A 250 V- 1M	44	KM11--	ZÁSUVKA TV KONCOVÁ 1 dB 1M	60
SM20	SPÍNAČ DVOJPÓLOVÝ 16 AX 250 V- 1M	44	KM12--	ZÁSUVKA TV PRIEBEŽNÁ 10 dB 1M	60
SM40	SPÍNAČ ŽALÚZIOVÝ 1-0-2 16 AX 250 V- 1M	45	KM15--	ZÁSUVKA SAT ZÁKLADNÁ 0 dB 1M	61
SM41	TLAČIDLO ŽALÚZIOVÉ 1-0-2 16 A 250 V- 1M	45	KM24--	ZÁSUVKA SAT ZÁKLADNÁ 0 dB 2M	61
SM60	SPÍNAČ STRIEDAVÝ 16 AX 250 V- 1M	45	KM16--	ZÁSUVKA SAT KONCOVÁ 1dB 1M	61
SM61	TLAČIDLO STRIEDAVÉ 16 A 250 V- 1M	45	KM19--	ZÁSUVKA R ZÁKLADNÁ 0 dB 1M	62
SM70	SPÍNAČ KRÍŽOVÝ 16 AX 250 V- 1M	45	KM29--	ZÁSUVKA R ZÁKLADNÁ 0 dB 2M	62
SM10--	SPÍNAČ JEDNOPÓLOVÝ 16 AX 250 V- 1M	46	KM17--	ZÁSUVKA SAT-TV KONCOVÁ 1 dB 1M	62
SM10--IN	SPÍNAČ JEDNOPÓLOVÝ 16 AX 250 V- 1M	46	KM22--	ZÁSUVKA AUDIO 2 x RCA 1M	63
SM11--	TLAČIDLO JEDNOPÓLOVÉ 16 A 250 V- 1M	46	KM23--	ZÁSUVKA AUDIO REPRODUKTOROVÁ 1M	63
SM11--IN01	TLAČIDLO JEDNOPÓLOVÉ 16 A 250 V- 1M IN 01	46	KM26--	ZÁSUVKA AUDIO REPRODUKTOROVÁ 2M	63
SM11--IN02	TLAČIDLO JEDNOPÓLOVÉ 16 A 250 V- 1M IN 02	47	KM30--	ZÁSUVKA TEL LT RJ11 6/4 1M	64
SM20--NT03	SPÍNAČ DVOJPÓLOVÝ 16 AX 250 V- 1M NT 03	47	KM31--	ZÁSUVKA TEL BT SEC 6/6 1M	64
SM20--IN	SPÍNAČ DVOJPÓLOVÝ 16 AX 250 V- 1M IN	47	KM36--	ZÁSUVKA TEL KS RJ11 6/4 1M	64
SM40--NT10	SPÍNAČ ŽALÚZIOVÝ 1-0-2 16 AX 250 V- 1M NT 10	47	KM37--	ZÁSUVKA KAT. 5e KS RJ45 8/8 1M	64
SM41--NT10	TLAČIDLO ŽALÚZIOVÉ 1-0-2 16 A 250 V- 1M NT 10	47	KM35--	ADAPTÉR KS 1M	64
SM60--	SPÍNAČ STRIEDAVÝ 16 AX 250 V- 1M	47	KM38--	ADAPTÉR KS S OCHRANOU PROTI PRACHU 1M	64
SM61--	TLAČIDLO STRIEDAVÉ 16 A 250 V- 1M	48	KM39--	ZÁSUVKA KS KAT. 6 SCH RJ45 8/8 1M	65
SM62--CD	TLAČIDLO STRIEDAVÉ S TIAHLOM 16 A 250 V- 1M CD	48	KM50--	ADAPTÉR KS UNIVERZÁLNY 1M	65
SM70--	SPÍNAČ KRÍŽOVÝ 16 AX 250 V- 1M	48	KM40--	ADAPTÉR PD 1M	65
TLAČIDLÁ TM			KM43--	ADAPTÉR PD S OCHRANOU PROTI PRACHU 1M	65
TM11--	KRYT TLAČIDLA 1M	49	KM46--	ADAPTÉR R&M 1M	66
TM11--IN	KRYT TLAČIDLA S INDIKÁTOROM 1M	49	KM52--	ADAPTÉR CAT6A 1M ZNAČKY R&M	66
TM12--	KRYT TLAČIDLA 2M	49	KM47--	ADAPTÉR R&M S OCHRANOU PROTI PRACHU 1M	66
TM12--IN	KRYT TLAČIDLA S INDIKÁTOROM 2M	49	KM53--	ADAPTÉR R&M CAT6A S OCHRANOU PROTI PRACHU 1M	66
TM13--IL	KRYT NA SPÍNAČ S POPISNÝM ŠTÍTKOM	50	KM45--	ADAPTÉR LK 1M	67
TM15--	KRYT NA SPÍNAČ DVOJPÓLOVÝ	50	KA26	ADAPTÉR NEXSANS/SCHRACK 2M	67
TM21--	VÝPLŇ 1M	50	KM48--	ADAPTÉR AT&T SYSTIMAX S OCHRANOU PROTI PRACHU 1M	67
TM22--	VÝPLŇ 2M	50	KM51--	USB ZÁSUVKA TYPU A 1M	67
TM31--	KÁBLOVÁ PRECHODKA 1M	50	KOMUNIKAČNÉ PRÍSLUŠENSTVO KA		
SIGNALIZÁCIA IA			KA10	KONEKTOR KS KAT. 3 RJ11 6/4	68
IA10--	TLEJIVKA 230 V ~ 0,34 W	52	KA11	KONEKTOR KS KAT. 5e RJ45 8/8	68
IA20--	LED SIGNALIZÁCIA 230V AC/DC 0,40W	52	KA12	KONEKTOR KS KAT. 5eS RJ45 8/8	68
IA21--	LED SIGNALIZÁCIA 24V AC/DC 0,20W	52	KA15	KONEKTOR KS KAT. 6 SCHRACK RJ45 8/8	69
IA22--	LED SIGNALIZÁCIA 12V AC/DC 0,10W	52	KA16	KONEKTOR KS KAT. 6S SCHRACK RJ45 8/8	69
IA50	RC OBVOD 250V ~	52	KA17	KONEKTOR KS KAT. 6a SCHRACK RJ45 8/8	69
SPÍNAČE SP			KA18	KONEKTOR SLIM KS KAT. 6S SCHRACK RJ45 8/8	69
SP10	SPÍNAČ JEDNOPÓLOVÝ 16AX 250 V- 1M	54	KA27	KONEKTOR KS HDMI	69
SP11	TLAČIDLO JEDNOPÓLOVÉ 16A 250 V- 1M	54	KA28	KÁBEL KS HDMI	69
SP12	SPÍNAČ JEDNOPÓLOVÝ 20A 250 V- 1M	54			
SP20	SPÍNAČ DVOJPÓLOVÝ 16AX 250 V- 1M	54			
SP40	SPÍNAČ ŽALÚZIOVÝ 1-0-2 16AX 250 V- 1M	55			
SP41	TLAČIDLO ŽALÚZIOVÉ 1-0-2 16 A 250 V- 1M	55			
SP60	SPÍNAČ STRIEDAVÝ 16AX 250 V- 1M	55			
SP61	TLAČIDLO STRIEDAVÉ 16A 250 V- 1M	55			
SP70	SPÍNAČ KRÍŽOVÝ 16AX 250 V- 1M	55			
ZÁSUVKY VM					
VM10--	ZÁSUVKA SCHUKO + KS 2P+E 16 A 250V ~ 2M	56			
VM11--	ZÁSUVKA SCHUKO + KS + KRYT 2P+E 16 A 250 V ~ 2M	56			
VM20--	ZÁSUVKA EURO + KS 2P 10 A 250 V ~ 1M	57			
VM40--	FRANCÚZSKÁ ZÁSUVKA +KS 2P+E 16 A 250 V ~ 2M	57			
VM41--	FRANCÚZSKÁ ZÁSUVKA + KS + KRYT 2P+E 16 A 250 V ~ 2M	57			
VM30--	TALIANSKA ZÁSUVKA P17/11 + KS 2P + E 16 A 250 V ~ 1M	57			
VM31--	ZÁSUVKA SCHUKO/ITA P17/11+KS 2P+E 16 A 250 V ~ 2M	57			
VM32--	ZÁSUVKA SCHUKO/ITA P30+KS 2P+E 16 A 250 V ~ 2M	58			
VM33--	TALIANSKA ZÁSUVKA P11+KS 2P+E 10 A 250 V ~ 1M	58			
VM21--	EURÓPSKA/AMERICKÁ ZÁSUVKA + KS 2P 16 A 250 V ~ 1M	58			
VM52--	BRITSKÁ ZÁSUVKA BS 1363-2 + KS 2P + E 13A 250 V ~ 2M	58			
VM55--	ZÁSUVKA VIACÚČELOVÁ+KS 2P+E 13A 250V~ 2M	58			
VM80	PREPÄŤOVÁ OCHRANA MPE MINI 275 V/50 Hz	58			

kód	popis výrobku	strana	kód	popis výrobku	strana
ELEKTRONIKA EM			RÁMIKY LINE OL		
EM12--	STMIEVAČ ROTAČNÝ/STRIEDAVÝ RL 300 W 1M	70	OL10--	RÁMIK LINE 1/2M	106
EM13--	STMIEVAČ ROTAČNÝ/STRIEDAVÝ LED 60 W 1M	71	OL20--	RÁMIK LINE 2M	106
EM14--	STMIEVAČ ROTAČNÝ/STRIEDAVÝ LED 180 W 1M	71	OL24--	RÁMIK LINE 2x2M	106
EM15--	STMIEVAČ ROTAČNÝ R 250 W 1M	72	OL26--	RÁMIK LINE 3x2M	106
EM23	ZABUDOVATEĽNÝ STMIEVAČ R (250 W), (EC, RL 200 VA)	72	OL28--	RÁMIK LINE 4x2M	106
EM16--	1-10 V STMIEVAČ ROTAČNÝ STRIEDAVÝ	73	OL29--	RÁMIK LINE 5x2M	106
EM17	OVLÁDACÍ MODUL MZC pre EM18	74	OL13--	RÁMIK LINE 1/3M	107
EM18	ZABUDOVATEĽNÝ STMIEVAČ LED 250W	74	OL30--	RÁMIK LINE 3M	107
EM19	ZABUDOVATEĽNÝ STMIEVAČ DC LED 96W	75	OL40--	RÁMIK LINE 4M	107
EM25--	UNIVERZÁLNY STMIEVAČ RLC 0-300 W 2M	76	OL70--	RÁMIK LINE 7M	107
EM26--	OVLÁDACIA JEDNOTKA STMIEVAČA 2M	78	OL71--	RÁMIK LINE 2x7M	107
EM25PPOL20	UNIVERZÁLNY STMIEVAČ RLC 0-300 W 2M PP OL20	78	OL23--	RÁMIK LINE 2/3M	107
EM27	FREKVENČNÝ FILTER	79	RÁMIKY SOFT OS		
EM28--	KRABICA POISTKY 230 VAC, 50 Hz 1M	79	OS10--	RÁMIK SOFT 1/2M	110
EM29	POISTKA	79	OS20--	RÁMIK SOFT 2M	110
EM31--	IR SPÍNAČ 5 A 230 V ~ 1M	79	OS24--	RÁMIK SOFT 2 x 2M	110
EM32--	IR SPÍNAČ 5 A 230 V ~ 2M	80	OS26--	RÁMIK SOFT 3 x 2M	110
EM33--	SENZOROVÝ SPÍNAČ 5 A 230 V ~ 1M	80	OS28--	RÁMIK SOFT 4 x 2M	110
EM38--	TERMOSTAT VYKUROVANIE 5(2)A 230 V~ 2M	82	OS13--	RÁMIK SOFT 1/3M	111
EM39--	TERMOSTAT VYKUROVANIE/CHLADENIE 3(1,5)A 230 V~ 2M	83	OS30--	RÁMIK SOFT 3M	111
NM39	MONTÁŽNY RÁMIK SO SKRUTKAMI PRE TERMOSTATY FANTINI COSMI 3M	84	OS40--	RÁMIK SOFT 4M	111
EM46--	KARTOVÝ SPÍNAČ 16 A / 230 VAC, 50 Hz 3M	84	OS70--	RÁMIK SOFT 7M	111
EM44--	KARTOVÝ SPÍNAČ JEDNOTKY PRE ÚSPORU ENERGIE RF HF 13,56MHz 3M	85	OS71--	RÁMIK SOFT 2x7M	111
EM47	KARTA ISO	85	OS72--	RÁMIK SOFT 2 x 7M	111
EM49	OVLÁDAČ JEDNOTKY PRE ÚSPORU ENERGIE 2 x 16A 250 V~	86	OS23--	RÁMIK SOFT 2/3M	111
EM45	ROZDELOVAČ SPL-1	86	RÁMIKY PURE OP		
EM60--	ZÁSUVKA NA HOLIACI STROJČEK 230 V~/120V~ 3M	87	OP20--	RÁMIK PURE 2M	116
EM57	LED NÚDZOVÉ OSVETLENIE 230 V ~ 0,5W, NiMH 2 h 2M	87	OP24--	RÁMIK PURE 2x2M	116
EM55	LED NÚDZOVÉ OSVETLENIE 250 V ~ 0,9W, NiCd 3h 7M	88	OP26--	RÁMIK PURE 3x2M	116
EM69--	NABÍJAČKA USB PD 20 W	89	OP28--	RÁMIK PURE 4x2M	116
EM50--	LED AMBIENTNÁ JEDNOTKA JEDNOFAREBNÁ 250 V ~ 0,8 W 2M	89	OP13--	RÁMIK PURE 1/3M	117
EM51--	SVIETIDLO LED DVOJFAREBNÉ 250 V ~ 2 x 0,4 W 2M	90	OP30--	RÁMIK PURE 3M	117
EM52--	3D SVIETIDLO LED DVOJFAREBNÉ 250 V ~ 2 x 0,4 W 2M	90	OP40--	RÁMIK PURE 4M	117
EM71--	SPÍNAČ NA ODTLAČKY PRSTOV BIOPASS 2M	91	OP70--	RÁMIK PURE 7M	117
EM82--	MULTIFUNKČNÝ ČASOVÝ SPÍNAČ EM82	92	OP23--	RÁMIK PURE 2/3M	117
EM90--	BZUČIAK 8 VA 230 V ~ 1M	94	RÁMIKY EDGE OG		
EM91--	BZUČIAK 8 VA 12 V ~ 1M	94	OG10--P	RÁMIK EDGE 1/2M	120
EM92--	ZVONČEK 8 VA 230 V ~ 1M	94	OG20--P	RÁMIK EDGE 2M	120
EM93--	ZVONČEK 8 VA 12 V ~ 1M	95	OG13--P	RÁMIK EDGE 1/3M	121
EM94--	ELEKTRONICKÝ ZVONČEK 230V- 6mA rms 1M	95	OG30--P	RÁMIK EDGE 3M	121
EM95--	REGULÁTOR HLASITOSTI 100 V 35 W 2M	96	OG40--P	RÁMIK EDGE 4M	121
EM96--	REGULÁTOR HLASITOSTI NÍZKONAPÄŤOVÝ 4-8 Ω 35 W 2M	96	OG70--P	RÁMIK EDGE 7M	121
EM96--	REGULÁTOR HLASITOSTI NÍZKONAPÄŤOVÝ 4-8 Ω 35 W 2M	96	OG23--P	RÁMIK EDGE 2/3M	121
SETI CM			RÁMIKY EDGE OG		
CM10--	SADA ZÁSUVIEK 2x SCHUKO 2P+E 16A 250V ~ 4M	97	OG10--M	RÁMIK EDGE 1/2M	123
CM11--	SADA ZÁSUVIEK 3x SCHUKO 2P+E 16A 250V ~ 7M	97	OG20--M	RÁMIK EDGE 2M	123
CM15	SÚPRAVA PREPOJOVACÍCH PRVKOV 3 x 1,5 mm ² 1M	98	OG24--M	RÁMIK EDGE 2x2M	123
CM16	SÚPRAVA PREPOJOVACÍCH PRVKOV 3 x 2,5 mm ² 2M	98	OG26--M	RÁMIK EDGE 3x2M	123
CM17	SÚPRAVA SKRUTIEK 3,5 x 20	98	OG28--M	RÁMIK EDGE 4x2M	123
CM18	SÚPRAVA SKRUTIEK 3,5 x 35	98	OG13--M	RÁMIK EDGE 1/3M	124
CM19	SÚPRAVA SKRUTIEK 3,5 x 50	98	OG30--M	RÁMIK EDGE 3M	124
CM22--	SADA IP 44 PRE SPÍNAČE S POPISNÝM ŠTÍTKOM 2M	98	OG40--M	RÁMIK EDGE 4M	124
CM23--	SADA IP44 PRE ZÁSUVKY S POPISNÝM ŠTÍTKOM 2M	98	OG70--M	RÁMIK EDGE 7M	124
CM25--OL	SÚPRAVA SPÍNAČOV DO KÚPEĽNE 3x 20A 250V ~ 4M OL	98	OG23--M	RÁMIK EDGE 2/3M	124
CM25--OS	SÚPRAVA SPÍNAČOV DO KÚPEĽNE 3x 20A 250V ~ 4M OS	98	MONTÁŽNE RÁMY NM		
CM28--	SADA IP 44 PRE SPÍNAČE 2M	99	NM10	MONTÁŽNY RÁM S ROZPERKAMI 1/2M	130
CM29--	SADA IP44 PRE ZÁSUVKY 2M	99	NM11	MONTÁŽNY RÁM BEZ SKRUTIEK 1/2M	130
NM41	MONTÁŽNY RÁM PRE KÚPEĽNOVÉ SADY 4M	99	NM20	MONTÁŽNY RÁM S ROZPERKAMI 2M	130
OL41--	RÁMIK PRE KÚPEĽNOVÚ SADU LINE	99	NM21	MONTÁŽNY RÁM BEZ SKRUTIEK 2M	130
OS41--	RÁMIK PRE KÚPEĽNOVÚ SADU SOFT	99	NM24	MONTÁŽNY KOVOVÝ RÁM S ROZPERKAMI 2M	131
ANTIBAKTERIÁLNY PROGRAM AW			NM25	MONTÁŽNY KOVOVÝ RÁM BEZ SKRUTIEK 2M	131
TM11AW	KRYT TLAČIDLA 1M	101	NM26	MONTÁŽNY RÁM VYSTUŽENÝ S ROZPERKAMI 2M	131
TM11AWIN	KRYT TLAČIDLA S INDIKÁTOROM 1M	101	NM27	MONTÁŽNY RÁM VYSTUŽENÝ BEZ SKRUTIEK 2M	131
TM12AW	KRYT TLAČIDLA 2M	101	NM23	MONTÁŽNY RÁM S ROZPERKAMI 2/3M	131
TM12AWIN	KRYT TLAČIDLA S INDIKÁTOROM 2M	101	NM30	MONTÁŽNY RÁM SO SKRUTKAMI 3M	132
TM21AW	VÝPLŇ 1M	101	NM40	MONTÁŽNY RÁM SO SKRUTKAMI 4M	132
TM22AW	VÝPLŇ 2M	101	NM70	MONTÁŽNY RÁM SO SKRUTKAMI 7M	132
VM10AW	ZÁSUVKA SCHUKO + KS 2P+E 16 A 250V ~ 2M	102	NM75	MONTÁŽNY RÁM VYSTUŽENÝ 7M ROZPERKAMI	132
VM11AW	ZÁSUVKA SCHUKO + KS + KRYT 2P+E 16 A 250 V ~ 2M	102	NM72	MONTÁŽNY RÁM SO SKRUTKAMI 2 x 7M	132
VM20AW	ZÁSUVKA EURO + KS 2P 10 A 250 V ~ 1M	102	NM32	MONTÁŽNY RÁM SO SKRUTKAMI 2/3M	133
KM11AW	ZÁSUVKA TV KONCOVÁ 1 dB 1M	102			
KM35AW	ADAPTÉR KS 1M	102			
OS20AW	RÁMIK SOFT 2M	103			
OS24AW	RÁMIK SOFT 2 x 2M	103			
OS26AW	RÁMIK SOFT 3 x 2M	103			
OS30AW	RÁMIK SOFT 3M	103			
OS40AW	RÁMIK SOFT 4M	103			
OS70AW	RÁMIK SOFT 7M	103			

K R A B I C E

distribúcia

kód	popis výrobku	strana	kód	popis výrobku	strana
OKRÚHLE KRABICE			KRABICE CUBO IP20 AC		
DE10	OKRÚHLA KRABICA DO STENY SM60-01	136	AC11--	KRABICA NO CUBO S KRYTOM ZADNEJ STRANY IP20 1M	158
DE11	OKRÚHLA KRABICA DO STENY HLBOKÁ SM60-06	136	AC21--	KRABICA NO CUBO S KRYTOM ZADNEJ STRANY IP20 2M	158
DE30	SPOJOVACÍ ČLÁNOK NA KRABICE DO STENY SM60-03	136	AC41--	KRABICA NO CUBO S KRYTOM ZADNEJ STRANY IP20 4M	158
DE31	SPOJOVACÍ ČLÁNOK NA KRABICE DO STENY SM60-04	136	AC61--	KRABICA NO CUBO S KRYTOM ZADNEJ STRANY IP20 6M	158
DE12	OKRÚHLA KRABICA DO STENY MD65-46	137	KRABICE CUBO IP55 AQ		
DE13	OKRÚHLA KRABICA DO STENY HLBOKÁ MD65-60	137	AQ20--	KRABICA NO CUBO IP55 2M	159
DE14	PREHLBENIE PRE MD65-46	137	AQ22--	KRABICA NO CUBO IP55 2x2M	159
DE32	SPOJOVACÍ ČLÁNOK NA KRABICE DO STENY MD65-71	137	AQ30--	KRABICA NO CUBO IP55 3M	159
DE33	SPOJOVACÍ ČLÁNOK NA KRABICE DO STENY MD65-91	137	AQ21	KRABICA PO CUBO IP55 2M	160
DE20	OCHRANNÝ KRYT KRABICE 60	137	AQ31--	KRABICA PO CUBO IP55 3M	160
DE21	OCHRANNÝ KRYT KRABICE 65	137	INŠTALAČNÝ SYSTÉM, HLINÍKOVÝ MA		
DE22	KRYT KRABICE SM60	137	RT10	ADAPTÉR MA 92	161
HE10	OKRÚHLA KRABICA – DUTÁ PRIEČKA SM68x40	140	RT12--	RÁMIK MA 92 2/3M	161
HE11	OKRÚHLA KRABICA – DUTÁ PRIEČKA SM68x55	140	RT14--	RÁMIK MA 92 4M	161
BE10	OKRÚHLA KRABICA - BETÓN 60-49	140	RT17--	RÁMIK MA 92 7M	161
BE11	OKRÚHLA KRABICA - BETÓN HLBOKÁ 60-77	140	RT20--	ZÁKLADNÝ PROFIL MA 130x65	162
BE20	MONTÁŽNY RÁM KRABICE DO BETÓNU	140	RT21--	ZÁKLADNÝ PROFIL MA 165x65	162
BE21	PRIECHODKA KRABICE DO BETÓNU 16	140	RT25--	PREDNÝ KRYT MA 92	162
OBĎLŽNIKOVÉ KRABICE			RT30	PRIEHRADKA MA 43	162
DM30	OBĎLŽNIKOVÁ KRABICA DO STENY PM3	144	RT31	PRIEHRADKA MA 43 AL	162
DM31	OBĎLŽNIKOVÁ KRABICA DO STENY PM3-65	144	RT32	PRIEHRADKA MA 43 AL DVOJITÁ	162
DM40	OBĎLŽNIKOVÁ KRABICA DO STENY PM4	144	RT35--	KONCOVÝ PRVOK MA 130x65	163
DM41	OBĎLŽNIKOVÁ KRABICA DO STENY PM4-65	144	RT36--	KONCOVÝ PRVOK MA 165x65	163
DM70	OBĎLŽNIKOVÁ KRABICA DO STENY PM7	145	RT38	SÚPRAVA SPOJOVACÍ PRVOK MA 65	163
DM71	OBĎLŽNIKOVÁ KRABICA DO STENY PM7-65	145	RT40--	UNIVERZÁLNY ROH MA 130x65	163
DM72	OBĎLŽNIKOVÁ KRABICA DO STENY PM72-65	145	RT41--	UNIVERZÁLNY ROH MA 165x65	163
DM80	ROZPERA PRE KRABICU PM	145	RT42	UZEMŇOVACIA SVORKA MA 2x A6.3	163
DM33	OCHRANNÝ KRYT PM3	146	RT43--	PRVOK V TVARE "L" MA 130x65 / 130	163
DM34	KRYT KRABICE DEKORATÍVNY PM3	146	RT44--	PRVOK V TVARE "L" MA 165x65 / 130	164
DM43	OCHRANNÝ KRYT PM4	146	RT47--	PRVOK V TVARE "L" MA 165x65 / 165	164
DM44	KRYT KRABICE DEKORATÍVNY PM4	146	RT45--	ROZDELOVACÍ PRVOK V TVARE "T" MA 130x65 / 130	164
DM73	OCHRANNÝ KRYT PM7	146	RT46--	ROZDELOVACÍ PRVOK V TVARE "T" MA 165x65 / 130	164
DM74	KRYT KRABICE DEKORATÍVNY PM7	164	RT48--	ROZDELOVACÍ PRVOK V TVARE "T" MA 165x65 / 165	164
DM75	KRYT KRABICE DEKORATÍVNY PM72	147	RT50--	UPEVŇOVACIA ZÁKLADŇA MA JEDNODUCHÁ 130x65	165
HM30	OVÁLNA KRABICA – DUTÁ PRIEČKA VM3	148	RT51--	UPEVŇOVACIA ZÁKLADŇA MA DVOJITÁ 130x65	165
HM40	OVÁLNA KRABICA – DUTÁ PRIEČKA VM4	148	RT52--	STĽPIK MA 130x65x500	165
HM70	OVÁLNA KRABICA – DUTÁ PRIEČKA VM7	148	RT53--	STĽPIK MA DVOJITÝ 130x130x500	165
HM72	OBĎLŽNIKOVÁ KRABICA – DUTÁ PRIEČKA VM72	148	PODLAHOVÉ KRABICE MT		
BM30	OBĎLŽNIKOVÁ KRABICA – BETÓN BM3	149	RB50	ZABUDOVATEĽNÁ PODLOŽKA PODLAHOVEJ KRABICE 4M	167
BM40	OBĎLŽNIKOVÁ KRABICA – BETÓN BM4	149	RB60	VLOŽKA PRE PODLAHOVÚ KRABICU 4M	167
BM70	OBĎLŽNIKOVÁ KRABICA – BETÓN BM7	149	RB65S1	KRYT NA PODLAHOVÚ KRABICU 4M	167
BM80	UPEVŇOVACÍ PRVOK NA KRABICU BM	149	RB51	ZABUDOVATEĽNÁ PODLAHOVÁ KRABICA 7M	167
BM82	DIŠTANČNÝ PROFIL NA KRABICE BM	149	RB61	VLOŽKA PRE PODLAHOVÚ KRABICU 7M	167
SPOJOVACIE KRABICE			RB66S1	KRYT NA PODLAHOVÚ KRABICU 7M	167
DW10	ROZVODNÁ KRABICA OKRÚHLA DO STENY DSM78	152	RB52	ZABUDOVATEĽNÁ PODLAHOVÁ KRABICA 2x7M	168
HW10	ROZVODNÁ KRABICA OKRÚHLA – DUTÁ PRIEČKA SM78x45	152	RB62	VLOŽKA PRE PODLAHOVÚ KRABICU 2x7M	168
DE23	KRYT KRABICE DEKORATÍVNY SM78	152	RB67S2	KRYT NA PODLAHOVÚ KRABICU 2X7M	168
DE24	OCHRANNÝ KRYT KRABICE 78	152	RB53	ZABUDOVATEĽNÁ PODLAHOVÁ KRABICA 4x7M	168
HW20	ROZVODNÁ KRABICA ŠTVORCOVÁ DUTÁ PRIEČKA SM105x105	152	RB62	VLOŽKA PRE PODLAHOVÚ KRABICU 2x7M	168
ELEKTROINŠTALAČNÝ MATERIÁL			RB68S2	KRYT NA PODLAHOVÚ KRABICU 4x7M	168
UW10--	JEDNORADOVÉ SVORKOVNICE ZATVORENÁ PC 2 x 2,5 mm ² 10P	154	RB55S1	PODLAHOVÁ KRABICA PRE DVOJITÚ PODLAHU S KRYTOM 4M	169
UW11--	JEDNORADOVÉ SVORKOVNICE ZATVORENÁ PC 2 x 4 mm ² 10P	154	RB60	VLOŽKA PRE PODLAHOVÚ KRABICU 4M	169
UW12--	JEDNORADOVÉ SVORKOVNICE ZATVORENÁ PC 2 x 6 mm ² 10P	154	RB56S1	PODLAHOVÁ KRABICA PRE DVOJITÚ PODLAHU S KRYTOM 7M	170
UW15--	JEDNORADOVÉ SVORKOVNICE PA 2 x 2,5 mm ² 12P	154	RB61	VLOŽKA PRE PODLAHOVÚ KRABICU 7M	170
UW16--	JEDNORADOVÉ SVORKOVNICE PA 2 x 4 mm ² 12P	154	RB57S2	PODLAHOVÁ KRABICA PRE DVOJITÚ PODLAHU S KRYTOM 2X7M	170
UW17--	JEDNORADOVÉ SVORKOVNICE PA 2 x 6 mm ² 12P	154	RB62	VLOŽKA PRE PODLAHOVÚ KRABICU 2x7M	170
UW29--	DVOJRADOVÉ SVORKOVNICE PP 1.0-4.0 mm ² 12P	154	RB58S2	PODLAHOVÁ KRABICA PRE DVOJITÚ PODLAHU S KRYTOM 4x7M	170
UW30--	DVOJRADOVÉ SVORKOVNICE PP 1.5-6.0 mm ² 12P	154	RB62	VLOŽKA PRE PODLAHOVÚ KRABICU 2x7M	170
UW31--	DVOJRADOVÉ SVORKOVNICE PP 2.5-10 mm ² 12P	154	RB10	ADAPTÉR NA DIN LIŠTU 35 mm 1M	171
UW32--	DVOJRADOVÉ SVORKOVNICE PP 4.0-16 mm ² 12P	154	RB11	ADAPTÉR NA DIN LIŠTU 35 mm 2M	171
UW27--	DVOJRADOVÉ SVORKOVNICE PA 2.5-10 mm ² 12P	155			
UW28--	DVOJRADOVÉ SVORKOVNICE PA 4.0-16 mm ² 12P	155			
UW40--	BEZSKRUTKOVÉ SVORKY PA 1,5 mm ² 3P	155			
UW41--	BEZSKRUTKOVÉ SVORKY PA 1,5 mm ² 5P	155			
UW42--	BEZSKRUTKOVÉ SVORKY PA 1,5 mm ² 8P	155			
UW45--	BEZSKRUTKOVÁ SVORKA PA 2,5 mm ² 3P	155			
UW46--	BEZSKRUTKOVÁ SVORKA PA 2,5 mm ² 4P	155			
UW47--	BEZSKRUTKOVÁ SVORKA PA 2,5 mm ² 5P	155			
UW50--	BEZSKRUTKOVÁ SVORKA PA 2,5 mm ² 2/1P	155			

kód	popis výrobku	strana	kód	popis výrobku	strana
SPÍNAČE SQ			KRYTY PQ		
SQ10--XO	SPÍNAČ JEDNOPÓLOVÝ 10 AX 250 V-	192	PQ10--XO	VÝPLŇ	213
SQ10--INXO	SPÍNAČ JEDNOPÓLOVÝ 10 AX 250 V-	192	PQ30--	KRYT TAE/TDO	213
SQ11--XO	TLAČIDLO JEDNOPÓLOVÉ 10 A 250 V-	192	PQ20PWF	KRABICA PRE POVRCHOVÚ MONTÁŽ 1	214
SQ11--IN01XO	TLAČIDLO JEDNOPÓLOVÉ 10 A 250 V- __ IN 01	192	PQ21PWF	POVRCHOVÁ KRABICA PRE DVOJITÚ ZÁSUVKU	214
SQ11--IN02XO	TLAČIDLO JEDNOPÓLOVÉ 10 A 250 V- __ IN 02	193	PQ22--F	SÚPRAVA SPÍNAČOV FLAT IP44	215
SQ11--ILXO	TLAČIDLO JEDNOPÓLOVÉ 10 A 250 V ~ __ IL	193	PQ23--F	SÚPRAVA ZÁSUVIEK FLAT IP44	215
SQ22--IN03XO	TLAČIDLO JEDNOPÓLOVÉ 16 AX 250 V- __ IN 03	193	RÁMIKY OF		
SQ50--XO	SPÍNAČ SÉRIOVÝ 10 AX 250 V-	193	OF10--	RÁMIK FLAT 1	216
SQ51--XO	TLAČIDLO SÉRIOVÉ 10 A 250 V-	193	OF20--	RÁMIK FLAT 2	216
SQ52--NT09XO	SPÍNAČ ŽALÚZIOVÝ 10 AX 250 V- __ NT 09	193	OF30--	RÁMIK FLAT 3	217
SQ53--NT09XO	TLAČIDLO ŽALÚZIOVÉ 10A 250V- __ NT 09	193	OF40--	RÁMIK FLAT 4	217
SQ60--XO	SPÍNAČ STRIEDAVÝ 10 AX 250 V-	193	OF50--	RÁMIK FLAT 5	217
SQ60--INXO	SPÍNAČ STRIEDAVÝ 10AX 250V- __ IN	194	RÁMIKY OQ		
SQ60--IN02XO	SPÍNAČ STRIEDAVÝ 10AX 250V- __ IN 02	194	OQ10--	RÁMIK BOLD 1	218
SQ63--XO	SPÍNAČ DVOJITÝ STRIEDAVÝ 10 AX 250 V-	195	OQ20--	RÁMIK BOLD 2	218
SQ70--XO	SPÍNAČ KRIŽOVÝ 10 AX 250 V-	195	OQ30--	RÁMIK BOLD 3	219
SIGNALIZÁCIA IA			OQ40--	RÁMIK BOLD 4	219
IA10--	TLEJIVKA 230 V- 0,34 W	196	OQ50--	RÁMIK BOLD 5	219
IA20--	LED SIGNALIZÁCIA 230 V AC/DC 0,4 W	196	RÁMIKY OR		
IA21--	LED SIGNALIZÁCIA 24 V AC/DC 0,2 W	196	OR10--	RÁMIK PRIME 1	222
IA22--	LED SIGNALIZÁCIA 12 V AC/DC 0,1 W	196	OR20--	RÁMIK PRIME 2	222
ZÁSUVKY VQ			OR30--	RÁMIK PRIME 3	221
VQ10--XO	ZÁSUVKA SCHUKO 2P + E 16 A 250 V- __ XO	199	OR40--	RÁMIK PRIME 4	221
VQ11--XO	ZÁSUVKA SCHUKO+KRYT 2P+E 16A 250V- __ XO	199			
VQ12--XO	ZÁSUVKA SCHUKO 2P + E 16 A 250 V- BV __ XO	199			
VQ13--XO	ZÁSUVKA SCHUKO+KRYT 2P + E 16 A 250 V- BV __ XO	199			
VQ40--XO	FRANCÚZSKA ZÁSUVKA 2P+E 16 A 250 V ~ __ XO	200			
VQ41--XO	FRANCÚZSKA ZÁSUVKA + KRYT 2P+E 16 A 250 V ~ __ XO	200			
VQ16--	ZÁSUVKA SCHUKO DVOJITÁ 2P + E 16 A 250 V-	200			
VQ16--F	ZÁSUVKA SCHUKO DVOJITÁ 2P + E 16 A 250 V-	200			
VQ42--XO	FRANCÚZSKA ZÁSUVKA 2P+E 16 A 250 V ~ BV __ XO	201			
VQ43--XO	FRANCÚZSKA ZÁSUVKA + KRYT 2P+E 16 A 250 V ~ BV __ XO	201			
VQ46--XO	FRANCÚZSKA ZÁSUVKA DVOJITÁ 2P+E 16 A 250 V ~	201			
VQ46--F	FRANCÚZSKA ZÁSUVKA DVOJITÁ 2P+E 16 A 250 V ~	201			
KOMUNIKÁCIE KQ					
KQ10--XO	ZÁSUVKA TV ZÁKLADNÁ 0 dB	202			
KQ11--XO	ZÁSUVKA TV-R KONCOVÁ 1 dB	202			
KQ12--XO	ZÁSUVKA TV-R PRIEBEŽNÁ 10 dB	203			
KQ16--XO	ZÁSUVKA SAT-TV-R KONCOVÁ 3 dB	203			
KQ22--XO	ZÁSUVKA AUDIO 2 x RCA	203			
KQ23--XO	ZÁSUVKA AUDIO REPRODUKTOROVÁ	204			
KQ36--XO	ZÁSUVKA TEL KS RJ11 6/4	204			
KQ37--XO	ZÁSUVKA CAT5e KS RJ45 8/8	204			
KQ38--XO	ZÁSUVKA TEL KS DVOJITÁ 2 x RJ11 6/4	204			
KQ39--XO	ZÁSUVKA CAT5e KS DVOJITÁ 2 x RJ45 8/8	205			
KQ35--XO	ZÁSUVKA TEL LT RJ11 6/4	205			
KQ40--XO	ZÁSUVKA CAT6s KS RJ45 8/8 SLIM	205			
KQ41--XO	ZÁSUVKA CAT6s KS DVOJITÁ 2 x RJ45 8/8 SLIM	205			
ELEKTRONIKA EQ					
EQ15--XO	STMIEVAČ ROTAČNÝ STRIEDAVÝ RL 400 W	206			
EQ16--XO	STMIEVAČ ROTAČNÝ STRIEDAVÝ RLC 400 W	206			
EQ19--XO	STMIEVAČ ROTAČNÝ STRIEDAVÝ LED 100 W	206			
EM17	OVLÁDACÍ modul MZC pre EM18	208			
EM18	ZABUDOVATEĽNÝ STMIEVAČ LED 250W	208			
EM19	ZABUDOVATEĽNÝ STMIEVAČ DC LED 96W	209			
EQ32--XO	IR SPÍNAČ 5 A 230 V-	210			
EQ35--XO	TERMOSTAT VYHRIEVANIE 10 A 230 V-	210			
EQ36--XO	TERMOSTAT VYHRIEVANIE/CHLADENIE 5 A 230 V-	210			
EQ37--XO	TERMOSTAT PODLAHOVÉ VYHRIEVANIE 16 A 230 V-	211			
EQ01--XO	RÁDIO NA ZAPUSTENÚ MONTÁŽ + REPRODUKTOR DAB BLUETOOTH	211			
EQ02--XO	REPRODUKTOR NA ZAPUSTENÚ MONTÁŽ	211			
EQ69--XO	NABÍJAČKA USB PD 20 W	212			

kód	popis výrobku	strana	kód	popis výrobku	strana
VYPÍNAČE SE			KRYTY PA		
SE10	SPÍNAČ JEDNOPÓLOVÝ 10 AX 250 V ~	232	PE10--	KRYT TV-R 2P/3P	248
SE11	TLAČIDLO JEDNOPÓLOVÉ 10 A 250 V ~	232	PE20--	KRYT KS SAMOSTATNÝ	248
SE22	SPÍNAČ DVOJPÓLOVÝ 16AX 250V ~	232	PE21--	KRYT KS DVOJITÝ	248
SE50	SPÍNAČ SÉRIOVÝ 10 AX 250 V ~	232	PE30--	KRYT TAE/TDO	248
SE51	TLAČIDLO SÉRIOVÉ 10 A 250 V ~	233	ELEKTRONIKA EE		
SE52	ŽALÚZIOVÝ SPÍNAČ 10AX 250V ~	233	EE15	STMIEVAČ ROTAČNÝ STRIEDAVÝ RL 400 W	249
SE53	ŽALÚZIOVÉ TLAČIDLO 10 A 250 V ~	233	EE16	STMIEVAČ ROTAČNÝ STRIEDAVÝ RLC 400 W	249
SE60	STRIEDAVÝ PREPÍNAČ 10 AX 250 V ~	233	EE19	STMIEVAČ ROTAČNÝ STRIEDAVÝ LED 100 W	250
SE63	STRIEDAVÝ PREPÍNAČ DVOJITÝ 10 AX 250 V ~	233	EE32	IR SPÍNAČ 5 A 230 V ~	250
SE70	KRÍŽOVÝ PREPÍNAČ 10 AX 250 V ~	233	EE15--	STMIEVAČ ROTAČNÝ STRIEDAVÝ RL 400 W	251
SE10--	SPÍNAČ JEDNOPÓLOVÝ 10 AX 250 V ~	234	EE16--	STMIEVAČ ROTAČNÝ STRIEDAVÝ RLC 400 W	251
SE10--IN	SPÍNAČ JEDNOPÓLOVÝ 10 AX 250 V ~ __ IN	234	EE19--	STMIEVAČ ROTAČNÝ STRIEDAVÝ LED 100 W	251
SE11--	TLAČIDLO JEDNOPÓLOVÉ 10 A 250 V ~	234	EE32--	IR SPÍNAČ 5 A 250 V ~	251
SE11--TI50	TLAČIDLO JEDNOPÓLOVÉ 10 A 250 V ~ __ TI 50	234	EE69--	NABÍJACKA USB PD 20 W	252
SE11--TI51	TLAČIDLO JEDNOPÓLOVÉ 10 A 250 V ~ __ TI 51	234	ELEKTRONICKÝ KRYT PE		
SE11--IL	TLAČIDLO JEDNOPÓLOVÉ 10 A 250 V ~ __ IL	234	PE41--	KRYT NA STMIEVAČ Ø 6	254
SE22--IN03	SPÍNAČ DVOJPÓLOVÝ 16 AX 250 V ~ __ IN 03	234	PE32--	KRYT IR SPÍNAČ	254
SE50--	SPÍNAČ SÉRIOVÝ 10 AX 250 V ~	235	PE67---	NABÍJACKA USB 5V 2,4A	254
SE51--	TLAČIDLO SÉRIOVÉ 10 A 250 V ~	235	PRÍSLUŠENSTVO AE		
SE52--NT09	ŽALÚZIOVÝ SPÍNAČ 10 AX 250 V ~ __ NT 09	235	AE10--	VÝPLŇ	255
SE53--NT09	ŽALÚZIOVÉ TLAČIDLO 10 A 250 V ~ __ NT 09	235	AE20--	SPOJOVACIA KRABICA PÄŤPÓLOVÁ 3P+N+E 5 x 4 mm ²	255
SE60--	STRIEDAVÝ PREPÍNAČ 10 AX 250 V ~	235	AE30--	KRABICA PRE POVRCHOVÚ MONTÁŽ 1	255
SE63--	STRIEDAVÝ PREPÍNAČ DVOJITÝ 10 AX 250 V ~	235	AE31--	POVRCHOVÁ KRABICA PRE DVOJITÚ ZÁSUVKU EKONOMIK	255
SE70--	KRÍŽOVÝ PREPÍNAČ 10 AX 250 V ~	235	AE50--	CHRÁNIČ STENY	256
OSVETLENIE TE			AE51--	DETSKÁ OCHRANA KS	256
TE10--	KRYT TLAČIDLA	236	RÁMIKY OE		
TE10--IN	KRYT TLAČIDLA S INDIKÁTOROM	236	OE10--	RÁMIK EKONOMIK 1	257
TE13--IL	KRYT TLAČIDLA S POPISNÝM ŠTÍTKOM	236	OE20--	RÁMIK EKONOMIK 2 HORIZONTÁLNY	257
TE11--	KRYT DVOJITÉHO TLAČIDLA	236	OE21--	RÁMIK EKONOMIK 2 VERTIKÁLNY	257
SIGNALIZÁCIA IA			OE30--	RÁMIK EKONOMIK 3 HORIZONTÁLNY	258
IA10--	TLEJIVKA 230 V ~ 0,34 W	237	OE31--	RÁMIK EKONOMIK 3 VERTIKÁLNY	258
IA20--	LED SIGNALIZÁCIA 230 V AC/DC 0,40 W	237	OE40--	RÁMIK EKONOMIK 4 HORIZONTÁLNY	258
IA21--	LED SIGNALIZÁCIA 24 V AC/DC 0,20 W	237	OE41--	RÁMIK EKONOMIK 4 VERTIKÁLNY	258
IA22--	LED SIGNALIZÁCIA 12 V AC/DC 0,10 W	237	OE50--	RÁMIK EKONOMIK 5 HORIZONTÁLNY	258
ZÁSUVKY VE			OE90--	DEKORATÍVNE RÁMIKY COLOUR	259
VE10--XO	ZÁSUVKA SCHUKO 2P+E 16 A 250 V ~ XO	240	fontana		
VE11--XO	ZÁSUVKA SCHUKO + KRYT 2P+E 16 A 250 V ~ XO	240	kód	popis výrobku	strana
VE12--XO	ZÁSUVKA SCHUKO 2P+E 16 A 250 V ~ BV XO	240	SPÍNAČE SF		
VE13--XO	ZÁSUVKA SCHUKO + KRYT 2P+E 16 A 250 V ~ BV XO	240	SF10--	SPÍNAČ JEDNOPÓLOVÝ IP44 10 AX 250 V ~	262
VE10--	ZÁSUVKA SCHUKO 2P+E 16 A 250 V ~	240	SF10--TI	SPÍNAČ JEDNOPÓLOVÝ IP44 10 AX 250 V ~ __ TI	262
VE11--	ZÁSUVKA SCHUKO + KRYT 2P+E 16 A 250 V ~	240	SF11--TI	TLAČIDLO JEDNOPÓLOVÉ IP44 10 A 250 V ~ __ TI	262
VE12--	ZÁSUVKA SCHUKO 2P+E 16A 250V ~ BV	240	SF20--	SPÍNAČ DVOJPÓLOVÝ IP44 10 AX 250 V ~	262
VE13--	ZÁSUVKA SCHUKO + KRYT 2P+E 16 A 250 V ~ BV	240	SF50--	SPÍNAČ SÉRIOVÝ IP44 10 AX 250 V ~	263
VE40--XO	FRANCÚZSKA ZÁSUVKA 2P+E 16 A 250 V ~ XO	241	SF51--	TLAČIDLO SÉRIOVÉ IP44 10 A 250 V ~	263
VE41--XO	FRANCÚZSKA ZÁSUVKA + KRYT 2P+E 16 A 250 V ~ XO	241	SF60--	STRIEDAVÝ PREPÍNAČ IP44 10 AX 250 V ~	263
VE42--XO	FRANCÚZSKA ZÁSUVKA 2P+E 16 A 250 V ~ BV XO	241	SF60--TI	STRIEDAVÝ PREPÍNAČ IP44 10 AX 250 V ~ __ TI	263
VE43--XO	FRANCÚZSKA ZÁSUVKA + KRYT 2P+E 16 A 250 V ~ BV XO	241	SF63--	STRIEDAVÝ PREPÍNAČ DVOJITÝ IP44 10 AX 250 V ~	263
VE40--	FRANCÚZSKA ZÁSUVKA 2P+E 16 A 250 V ~	241	SF70--	KRÍŽOVÝ PREPÍNAČ IP44 10 AX 250 V ~	263
VE41--	FRANCÚZSKA ZÁSUVKA + KRYT 2P+E 16 A 250 V ~	241	ZÁSUVKY VF		
VE42--	FRANCÚZSKA ZÁSUVKA 2P+E 16 A 250 V ~ BV	241	VF10--	ZÁSUVKA SCHUKO + KRYT IP44 2P+E 16 A 250 V ~	264
VE43--	FRANCÚZSKA ZÁSUVKA + KRYT 2P+E 16 A 250 V ~ BV	241	VF12--	ZÁSUVKA SCHUKO + KRYT IP44 2P+E 16 A 250 V ~ BV	264
VE16--	ZÁSUVKA SCHUKO DVOJITÁ 2P+E 16 A 250 V ~	242	SETI CF		
VE46--	FRANCÚZSKA ZÁSUVKA DVOJITÁ 2P+E 16 A 250 V ~	242	CF10--	SÚPRAVA ZÁSUVIEK SCHUKO DVOJITÁ HORIZONTÁLNA IP44 2 x 2x2P+E 16 A 250 V ~	265
VE30--	ZÁSUVKA 2P 16 A 250 V ~	242	CF11--	SÚPRAVA ZÁSUVIEK SCHUKO DVOJITÁ VERTIKÁLNA IP44 2 x 2x2P+E 16 A 250 V ~	265
KOMUNIKÁCIE KE			CF12--	ZÁSUVKA SCH + DVOJPÓLOVÝ SPÍNAČ HORIZONTÁLNY IP44 16 A + 10 AX 250 V ~	265
KE11	ZÁSUVKA TV-R KONCOVÁ 1 dB	243	CF13--	ZÁSUVKA SCH + SÚPRAVA DVOJPÓLOVÝCH SPÍNAČOV VERTIKÁLNA IP44 16 A + 10 AX 250 V ~	266
KE12	ZÁSUVKA TV-R PRIEBEŽNÁ 10 dB	243	CF14--	SÚPRAVA ZÁSUVIEK SCHUKO DVOJITÁ HORIZONTÁLNA IP44 2x 2P+E 16 A 250 V ~ BV	266
KE16	ZÁSUVKA SAT-TV-R KONCOVÁ 3 dB	243	CF15--	SÚPRAVA ZÁSUVIEK SCHUKO DVOJITÁ VERTIKÁLNA IP44 2x 2P+E 16 A 250 V ~ BV	266
KE36	ZÁSUVKA TEL KS RJ11 6/4	243	CF16--	ZÁSUVKA + SÚPRAVA SPÍNAČOV + DVOJPÓLOVÉ HORIZONTÁLNE IP44 16 A + 10 AX 250 V ~ BV	266
KE37	ZÁSUVKA KAT. 5e KS RJ45 8/8	244	CF17--	ZÁSUVKA + SÚPRAVA SPÍNAČOV + DVOJPÓLOVÉ VERTIKÁLNE IP44 16 A + 10 AX 250 V ~ BV	266
KE40	ZÁSUVKA KAT. 6s KS RJ45 8/8 SLIM	244	PRÍSLUŠENSTVO AF		
KE38	ZÁSUVKA TEL KS DVOJITÁ 2 x RJ11 6/4	244	AF10--	ROZVODNÁ KRABICA IP44 RN01	267
KE39	ZÁSUVKA KAT. 5e KS DVOJITÁ 2 x RJ45 8/8	244	AF20--	ROZVODNÁ KRABICA IP55 ND01	267
KE41	ZÁSUVKA KAT. 6s KS DVOJITÁ 2 x RJ45 8/8 SLIM	244			
KE45	ADAPTÉR KS SAMOSTATNÝ	244			
KE46	ADAPTÉR KS DVOJITÝ	245			
KE47	ADAPTÉR PD DVOJITÝ	245			
KE10--	ZÁSUVKA TV ZÁKLADNÁ 0dB	246			
KE11--	ZÁSUVKA TV-R KONCOVÁ 1 dB	246			
KE12--	ZÁSUVKA TV-R PRIEBEŽNÁ 10 dB	246			
KE16--	ZÁSUVKA SAT-TV-R KONCOVÁ 3 dB	246			
KE22--	AUDIO ZÁSUVKA 2xRCA	246			
KE23--	ZÁSUVKA AUDIO REPRODUKTOROVÁ	246			
KE36--	ZÁSUVKA TEL KS RJ11 6/4	246			
KE37--	ZÁSUVKA KAT. 5e KS RJ45 8/8	247			
KE40--	ZÁSUVKA KAT. 6s KS RJ45 8/8 SLIM	247			
KE38--	ZÁSUVKA TEL KS DVOJITÁ 2 x RJ11 6/4	247			
KE39--	ZÁSUVKA KAT. 5e KS DVOJITÁ 2 x RJ45 8/8	247			
KE41--	ZÁSUVKA KAT. 6s KS DVOJITÁ 2 x RJ45 8/8 SLIM	247			
KE35--	ZÁSUVKA TEL LT RJ11 6/4	247			



TEM
On | Off and everything in between

ekonomik
MODUL
LOGIQ

100% ELEKTRIČEN

www.tem.si



TEM
On | Off and everything in between



TEM

M
n between



www.tem.si

TEM

TEM ČATEŽ d.o.o.
Čatež 13, 8212 VELIKA LOKA
SLOVENIJA
tem@tem.si
www.tem.si

T +386(0)7 348 99 00

SK